



 FLASHAAR



LICHT auf ganzer Linie

LIGHTING all along the line



Kloster Bonlanden

Dezente Lichtlinien in exzellenter Lichtqualität schaffen ein gleichmäßiges, Raum hebendes Deckenlicht im denkmalgeschützten Haus Faustin Mennel im Kloster Bonlanden.

Bonlanden Monastery

Discreet light lines in excellent lighting quality create an even, room-lifting ceiling light in the listed Faustin Mennel House in Bonlanden Monastery.

Licht auf ganzer Linie

lighting all along the line



Innovative und maßgeschneiderte LED-Technologien – Made in Germany

innovative and customised LED technologies – made in Germany

FLASHAAR® verbindet Erfindergeist, einen hohen Qualitätsanspruch und zukunftsweisendes Handwerk mit Hightech:

Mit dem Einsatz von modernster LED-Technik, einer hohen Fertigungstiefe und der Qualitätssicherung im hauseigenen Lichtlabor schaffen wir Produkte von kompromissloser Qualität.

Basierend auf einer einzigartigen Plug&Play Technologie für Leuchten, entwickeln und produzieren wir seit über 16 Jahren LED-Systembaukästen. Forschung und Entwicklung, Vertrieb und Produktion arbeiten Hand in Hand und im engen Austausch unter einem Dach. Wir sehen uns als Manufaktur, weil bei uns alles, vom Design bis hin zur Fertigung, Handarbeit ist.

Unser Ziel: Wachstum im Einklang mit Umwelt- und gelebtem Klimaschutz. Unsere energiesparenden Lichtlösungen ersetzen alte Beleuchtungen mit hohem Energiebedarf und sparen dadurch große Mengen an klimaschädlichem CO₂. Wir achten auf kurze Transportwege zu unseren Lieferanten und auf eine ressourcenschonende Herstellung. Dabei verwenden wir ausschließlich schadstofffreie und recyclefähige Materialien. Dank der Plug&Play Technologie lassen sich unsere LED Leuchteneinsätze werkzeuglos austauschen.

Unsere innovativen Profilsysteme und energieeffizienten Beleuchtungslösungen inszenieren moderne und historische Bauwerke, unterstreichen ausgefallene Designkonzepte und sorgen für funktionale Beleuchtung. Lichtplaner und Architekten, Hoteldesigner und Ausstatter im Yachtbau setzen auf unsere Qualitätsprodukte „Made in Germany“; mit vielen von ihnen verbindet uns eine langjährige Partnerschaft, gewachsen aus zahlreichen Projekten in ganz Deutschland und international.

Größtmögliche Freiheit beim Gestalten mit Licht, eine klare Formensprache und ein Design, welches sich in die verschiedensten architektonischen Umgebungen mühelos integriert. Konzentration auf das Maximum des Machbaren und Lösungen, die immer perfekt zu den sich ändernden Anforderungen passen. Dafür steht FLASHAAR® – nehmen Sie uns beim Wort.

Swen Flashaar-Bloedorn
Geschäftsführer/CEO



FLASHAAR® combines ingenuity, high quality standards and future-oriented craftsmanship with high-tech components:

By using state-of-the-art LED technology, a high degree of production depth and quality assurance in our in-house lighting laboratory, we create products without compromising on quality.

Based on a unique Plug&Play technology for lighting, we have been developing and producing LED system kits for over 16 years. Research and Development, Sales, and Production teams work hand in hand and in close cooperation under one roof. We see ourselves as a manufactory because everything from design to production is handmade.

Our goal: Achieving growth whilst protecting the environment and the climate. Our energy-saving lighting solutions replace old lighting systems which consume large amounts of energy and thus greatly reduce CO₂ emissions. We take care to ensure short transport routes to our suppliers and only use pollutant-free and recyclable materials. Thanks to Plug&Play technology, our LED light inserts can be replaced without tools.

Our innovative profile systems and energy-efficient lighting solutions showcase modern and historic buildings, underscore unusual design concepts and provide functional lighting. Lighting planners, architects, hotel designers and yacht outfitters all rely on our quality products that are exclusively “Made in Germany”; we have long-standing partnerships with many of them, which have grown out of numerous projects throughout Germany and internationally.

We provide the greatest possible freedom in lighting design, a clear design language, and a design that integrates effortlessly into a wide variety of architectural environments. We focus on maximising what is feasible and solutions that are always perfectly suited to changing requirements. This is what FLASHAAR® stands for – you can take our word for it.



Zertifiziertes Qualitäts- und Umweltmanagementsystem
DIN EN ISO 9001 / 14001

GESTALTEN MIT LICHT DESIGNING WITH LIGHT

HANDLÄUFE mit integrierter LED Beleuchtung, blendfreie, zielgerichtete Lichtlinien und Spezialanfertigungen.

HANDRAILS with integrated LED illumination, glare-free, targeted light lines and custom-made products.

© Gustav-Mahler-Treppe, Kassel / Nikolai Benner

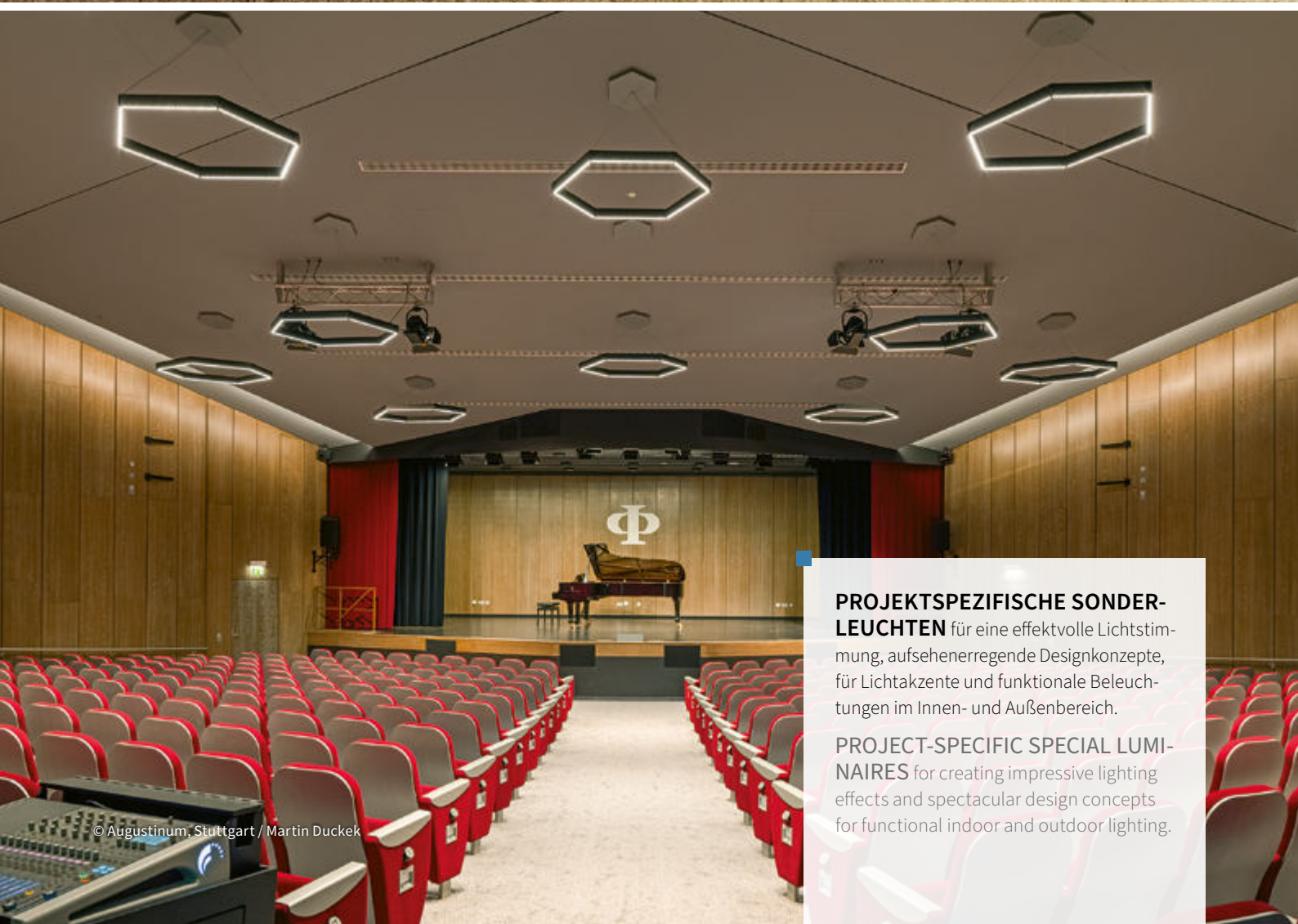

PROJEKTSPEZIFISCHE SONDERLEUCHTEN für eine effektvolle Lichtstimmung, aufsehenerregende Designkonzepte, für Lichtakzente und funktionale Beleuchtungen im Innen- und Außenbereich.

PROJECT-SPECIFIC SPECIAL LUMINAIRES for creating impressive lighting effects and spectacular design concepts for functional indoor and outdoor lighting.

© Augustinum, Stuttgart / Martin Duckek

LANGE LICHTLINIEN mit nur einer einzigen elektrischen Einspeisung – unkompliziert bei der Planung und Installation.

LONG LIGHT LINES with a single electrical feed – uncomplicated planning and installation.



© Südentor, Lippstadt / Thomas Rensinghoff / Hellweg Fotografie

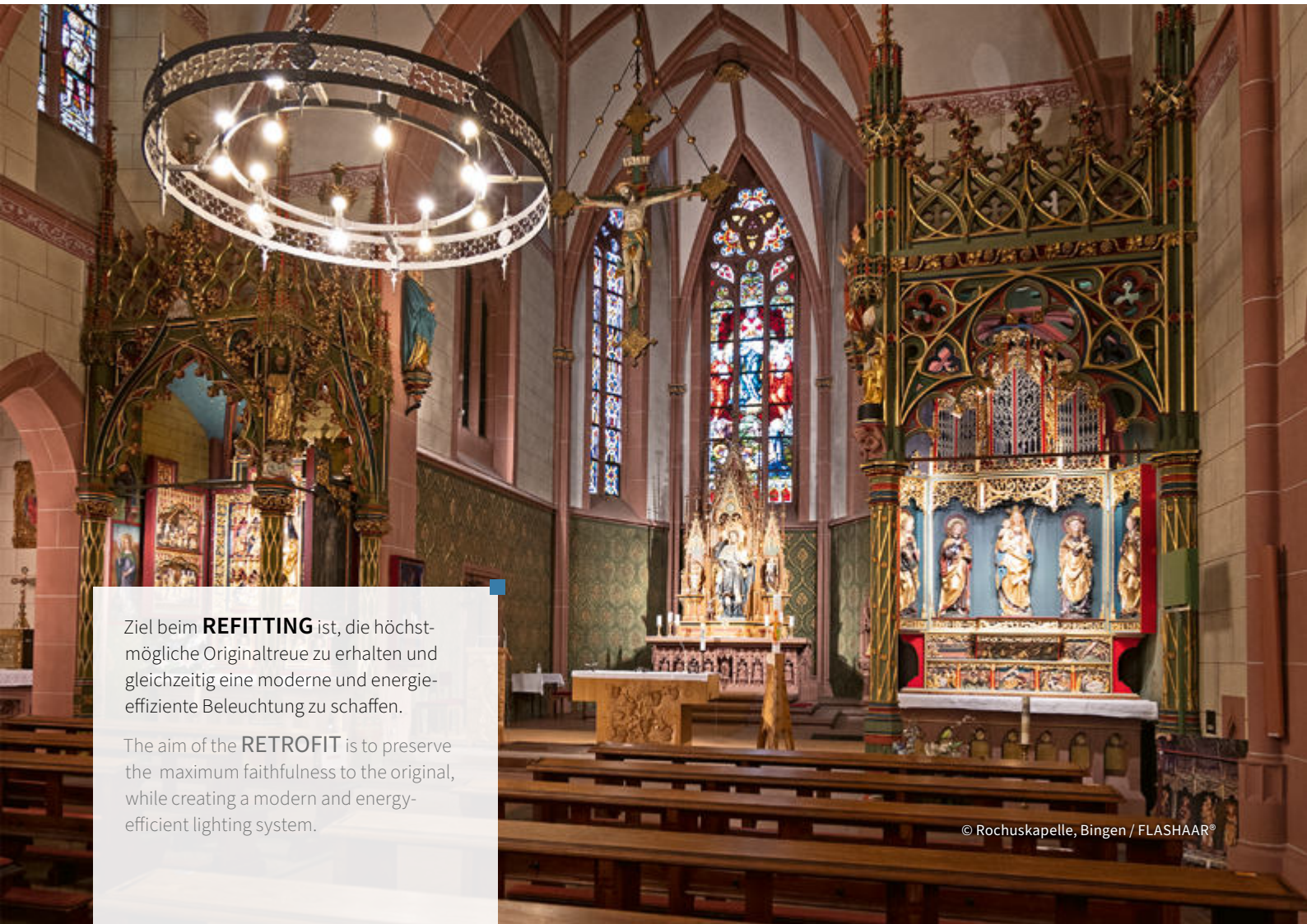

Ziel beim **REFITTING** ist, die höchstmögliche Originaltreue zu erhalten und gleichzeitig eine moderne und energieeffiziente Beleuchtung zu schaffen.

The aim of the **RETROFIT** is to preserve the maximum faithfulness to the original, while creating a modern and energy-efficient lighting system.

© Rochuskapelle, Bingen / FLASHAAR®

Unsere FLASHAAR® Leuchtenfamilien in der Übersicht

Our FLASHAAR® luminaire families at a glance

NauticProfil® System

= NP System

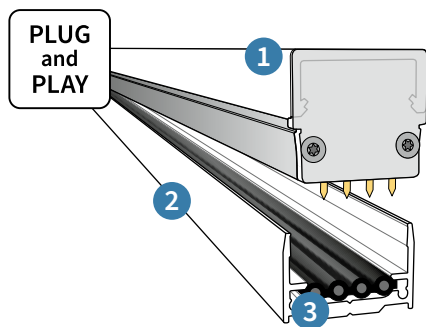

CLICK!

- lange Lichtlinien mit einem einfachen KLICK
- schnelle & einfache Verkabelung
- eine elektrische Einspeisung für mehrere Leuchten
- Baukastenprinzip: breite Palette an Montageprofilen und variablen Leuchteneinsätzen

- long light lines with a simple CLICK
- quick & easy wiring
- one electrical feed for several luminaires
- modular principle: wide range of mounting profiles and variable luminaire inserts

1 NP Leuchteneinsätze NP light inserts

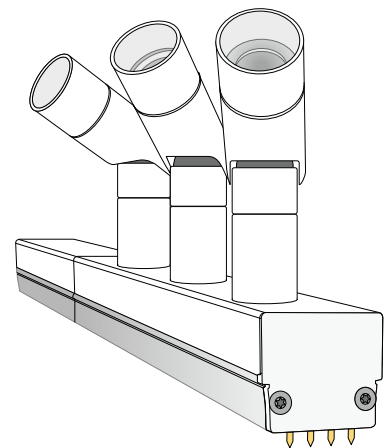
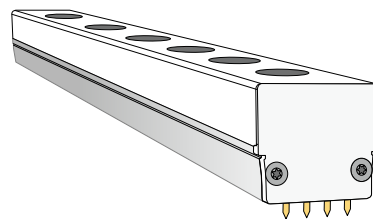
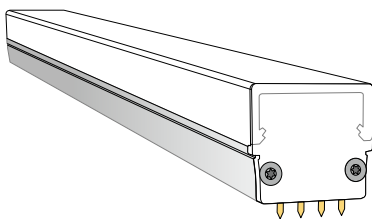

NP Line

- Midpower-LEDs
- hohe Effizienz, hervorragende Wärme-stabilität, sehr hohe Lebensdauer
- CRI von >80 sowie >90
- zahlreiche Varianten für Innen & Außen
- Mid-power LEDs ensure high efficiency, excellent thermal stability and a very long service life
- CRI of >80 and >90
- numerous variants for indoor & outdoor

NP Focus

- Highpower-LEDs
- Präzisionslinsen
- für besonders lichtstarke Anwendungen
- hervorragende Lichtqualität
- 1-Kanal oder 4-Kanal
- High-power LEDs
- precision lenses
- for particularly bright applications
- outstanding light quality
- 1-channel or 4-channel

NP PicoSpots

- LEDs kombiniert mit Präzisionslinsen
- individuelle Anzahl von Spots
- hohe Farbwiedergabe
- maximale Effizienz
- LEDs combined with precision lenses
- individual number of spots
- high colour rendering
- maximum efficiency

2 NP Montageprofile & 3 NP Flachkabel NP mounting profile & NP flat cable

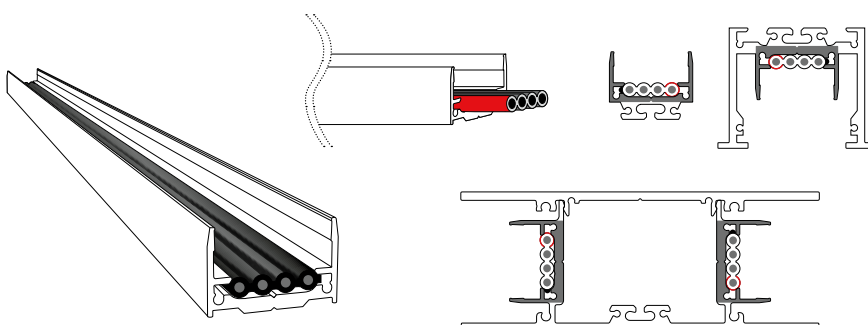

- 13 verschiedene Montageprofile zur Auswahl für Anbau- / Einbau- / Pendelleuchten
- zahlreiche Clips zur Montage
- Zuschnitt und Verarbeitung auf Maß

- 13 different mounting profiles to choose from for surface-mounted / recessed / pendant luminaires
- numerous clips for mounting
- cut to size and processed to measure



© Lahmeyerbrücke, Frankfurt / Christian Hattemer

H2flex Systembaukasten H2flex modular system

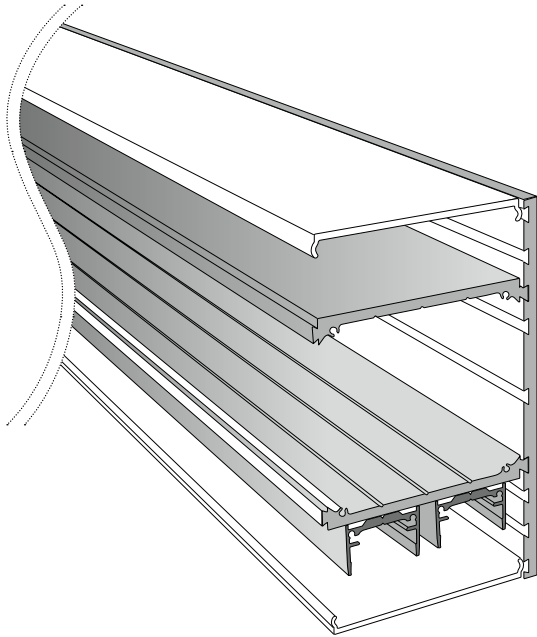

- raumbildender Systembaukasten
- maximale gestalterische Freiheit
- unzählige Leuchtenvarianten sind realisierbar
- NauticProfil® Leuchten lassen sich problemlos integrieren
- space-forming modular system
- maximum creative freedom
- countless luminaire variants can be realised
- NauticProfil® luminaires can be integrated without any problems

LED Spots und Strahler LED spots and spotlights

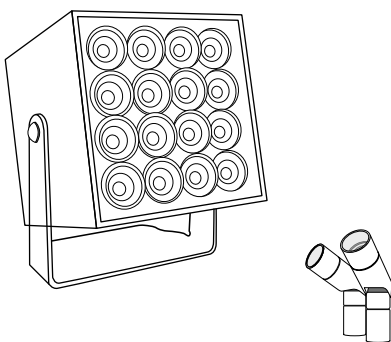

- effiziente LED Spots und Strahler für den Innen- & Außenbereich
- maßgefertigte, projektspezifische Spotleuchten
- flexibel bestückbare Strahler
- lichtstark und fokussiert
- efficient LED spots and spotlights for indoor & outdoor use
- customised, project-specific spotlights
- flexible spotlights
- light-intensive and focused

Inhaltsverzeichnis

contents

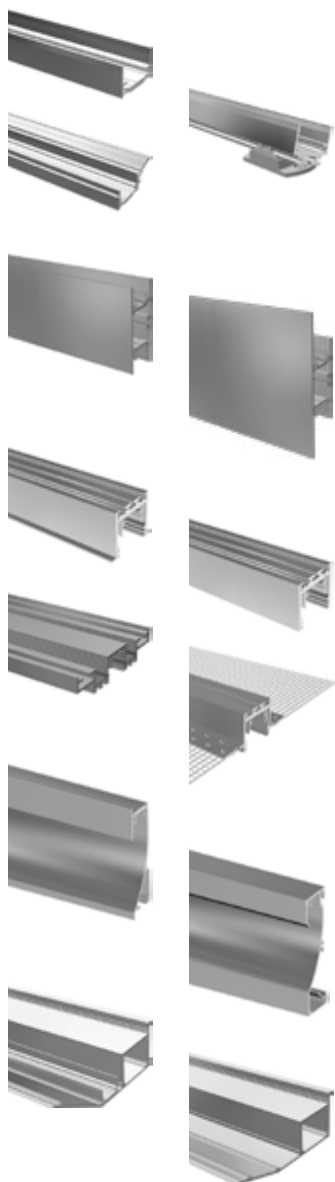
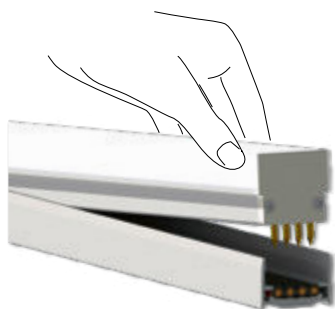

Einleitung editorial	3
FLASHAAR® Leuchtenfamilien in der Übersicht FLASHAAR® luminaire families at a glance	6
Neu bei FLASHAAR® new at FLASHAAR®	13-15
Forschung, Entwicklung und Produktion research, development and production	19
TOP 100 Innovator 2019 + 2021 TOP 100 innovator 2019 + 2021	20
Meilensteine milestones	22
NauticProfil® System	24
NauticProfil® System – Was gehört dazu und wie funktioniert es? NauticProfil® System - What is involved and how does it work?	26
Artikelnummern-Konzept item numbers concept	29
NauticProfil® Montageprofile NauticProfil® mounting profiles	31-71
NP Montageprofile und Optionen NP mounting profiles and options	31-36
NauticProfil® S1 – Aufbauprofil klassisch NauticProfil® S1 – surface-mounted profile	38
NauticProfil® S2 – Aufbauprofil für Montageclips NauticProfil® S2 – surface-mounted profile for mounting clips	40
NauticProfil® S3 – Einbauprofil für Fassaden NauticProfil® S3 – mounting profile for facades	42
NauticProfil® H1 – Aufbauprofil mit zweiseitiger Abstrahlung NauticProfil® H1 – surface-mounted profile with two-sided radiation	46
NauticProfil® H2 – Aufbauprofil mit zweiseitiger Abstrahlung, blendfrei NauticProfil® H2 – surface-mounted profile with two-sided radiation, glare-free	48
NauticProfil® R1 – Einbauprofil mit Rahmen NauticProfil® R1 – recessed profile with frame	52
NauticProfil® R2 – Einbauprofil ohne Rahmen NauticProfil® R2 – recessed profile without frame	54
NauticProfil® R3 – Einbauprofil ohne Rahmen für Decken NauticProfil® R3 – recessed profile without frame for ceilings	56
NauticProfil® R4 – Einbauprofil ohne Rahmen für Fassaden NauticProfil® R4 – recessed profile without frame for facades	58
NauticProfil® I1 – Einbauprofil für indirekte Beleuchtung NauticProfil® I1 – recessed profile for indirect lighting	62
NauticProfil® I2 – Aufbauprofil für indirekte Beleuchtung NauticProfil® I2 – surface-mounted profile for indirect lighting	64
NauticProfil® W1 – Anbauprofil für Voutenbeleuchtung NauticProfil® W1 – surface-mounted profile for cove lighting	68
NauticProfil® W2 – Aufbauprofil für Voutenbeleuchtung, flach NauticProfil® W2 – surface-mounted profile for cove lighting, flat	70

Inhaltsverzeichnis

contents



NauticProfil® Extension-1

NauticProfil® Extension-1

74 - 75

NauticProfil® Extension-1 G1 – schwenkbare Lichtlinien NauticProfil® Extension-1 G1 – swivel-mounted light lines	74
---	----

NauticProfil® Extension-1 G2 – schwenkbare Lichtlinien, blendfrei NauticProfil® Extension-1 G2 – swivel-mounted light lines, glare-free	75
--	----

NauticProfil® Leuchteneinsätze

NauticProfil® light inserts

76 - 141

NauticProfil® Cover und Linsen NauticProfil® cover and lenses	78
--	----

Klassische Anwendungsbeispiele für lineare Leuchten classic application examples for linear luminaires	80
---	----

NauticProfil® LED Serien in der Übersicht NauticProfil® LED series at a glance	84
---	----

NauticProfil® Mayflower-3 (302 lm/m, CRI > 90, 24V DC, 99m per feed-in)	88
---	----

NauticProfil® Sta-Maria-6 (654 lm/m, CRI > 90, 48V DC, 100m per feed-in)	92
--	----

NauticProfil® Victory-7 (1282 lm/m, CRI > 90, 48V DC, 70m per feed-in)	98
--	----

NauticProfil® Navigator-3 (1576 lm/m, CRI > 80, 48V DC, 70m per feed-in)	104
--	-----

NauticProfil® Jago-2 (3112 lm/m, CRI > 90, 48V DC, 42m per feed-in)	110
---	-----

NauticProfil® Nova-6 (3790 lm/m, CRI > 80, 48V DC, 42m per feed-in)	116
---	-----

NauticProfil® Pegasus-4 (2000 lm/m, CRI 80/90, 24V DC, 16m per feed-in)	122
---	-----

NauticProfil® Defiant (1200 lm/m (dimmed) RGB, 48V DC, 28m per feed-in)	132
---	-----

NauticProfil® Blind (Profilabdeckung / profile cover)	140
---	-----

NauticProfil® Focus Leuchteneinsätze

NauticProfil® Focus light inserts

142 - 169

NauticProfil® Focus Leuchteneinsätze – Übersicht und Optionen NauticProfil® Focus light inserts – overview and options	144
---	-----

NauticProfil® Focus-4 1CH (4400 lm/m, CRI > 90, 48V DC, 12m per feed-in (dimmed))	148
---	-----

NauticProfil® Focus-4 1CH DL (4400 lm/m, CRI > 90, 48V DC, 15m per feed-in (dimmed))	154
--	-----





NauticProfil® Focus-3 4CH (3028 lm/m, CRI > 90, typ. 350mA)	160
---	-----

NauticProfil® Focus-3 4CH DL (3028 lm/m, CRI > 90, typ. 350mA)	164
--	-----

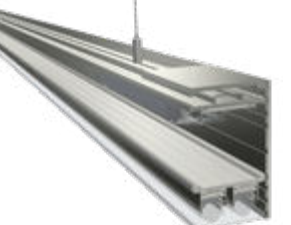

Inhaltsverzeichnis

contents

	NauticProfil® PicoSpot Familie NauticProfil® PicoSpot family 170-179
	NauticProfil® PicoSpot – minimalistische Akzentbeleuchtung 173 NauticProfil® PicoSpot – minimalist accent lighting
	FLASHAAR® Pico Konstantstrom Platine-1 178 FLASHAAR® Pico constant current board-1
	NauticProfil® Sonderanfertigungen – mehr als nur Standard NauticProfil® custom-made products – more than just standard 180-195
	NauticProfil® Profilfarben 184 NauticProfil® profile colours
	NauticProfil® Ecklösungen 185 NauticProfil® corner solutions
	FLASHAAR® PremiumCoating 186
	FLASHAAR® ILAF 188
	FLASHAAR® SAPP 1000 / 1500 192
	NauticProfil® Zubehör NauticProfil® accessories 196-201
	NauticProfil® Verdrahtungsschemata NauticProfil® wiring diagrams 202-223
	H2flex Systembaukasten H2flex modular system 224-237
	H2flex – Was gehört dazu? 226 H2flex – What is involved?
	H2flex – Licht, wie und wo Sie planen 229 H2flex – light, how and where to plan
	H2flex – Anwendungsbeispiele 232 H2flex – examples of applications
	H2flex-U1 – stabiler Leuchtenkörper 236 H2flex-U1 – stable luminaire body
	LED Spots & Strahler LED spots & spotlights 238-253
	FLASHAAR® LED Spots und Strahler – Was gehört dazu? 240 FLASHAAR® – LED spots and spotlights – What is involved?
	Solaris-2 – RGBW-Spot für Innen- und Außenräume 242 Solaris-2 – RGBW spot for indoor and outdoor spaces
	DB/Bahnsteigleuchte 250 DB platform light

Inhaltsverzeichnis

contents



Technisches Equipment technical equipment	254 - 259
Konverter Konstantspannung power supply units constant voltage	257
Dimmer Konstantspannung dimmer constant voltage	258
Dimmer Konstantstrom dimmer constant current	259
Lichtsteuerung per App – Casambi lightcontrolling via app – Casambi	260 - 263
Allgemeine Geschäftsbedingungen / Bestellinformation general terms and conditions of business / delivery information	264 - 266



Neu bei FLASHAAR®

new at FLASHAAR®



Perfekt gerüstet mit unserer neuen LED Platinen Generation

Perfectly equipped with our new LED board generation

Immer wieder wurden wir damit konfrontiert, dass wir nicht bis in die letzte Ecke unsere homogenen Lichtlinien ausführen konnten. Grund war unser bisheriges LED-Teilungsraster von 100 mm oder 50 mm. Kompromisse bei der Gestaltung waren notwendig.

Again and again, we were confronted with the fact that we could not execute our homogeneous light lines right into the last corner. The reason was our previous LED pitch of 100 mm or 50 mm. Compromises in the design were necessary.

Unsere neue LED Platinen Generation ermöglicht jetzt eine kompromisslos homogene Umsetzung von Lichtlinien bis in die letzte Ecke. Ermöglicht wird dies von einer LED Platinen Familie die alle positiven Eigenschaften der bisherigen FLASHAAR® Alukernplatinen vereint. Basis bildet unsere Alukernplatine mit einer Länge von 500 mm, insgesamt 5 Modulen und jeweils 15 LED. Das ergibt insgesamt 150 LED auf einem Meter.

Our new generation of LED boards now enables uncompromisingly homogeneous implementation of light lines right into the last corner. This is made possible by an LED panel family that combines all the positive properties of the previous FLASHAAR® aluminium core panels. The basis is our aluminium core board with a length of 500 mm, a total of 5 modules and 15 LEDs each. That makes a total of 150 LEDs on one metre.

Wir konnten den Pitch erneut reduzieren auf jetzt nur noch 6,6mm. Das ermöglicht sogar in Kombination mit Linearlinsen ein deutlich gleichmäßigeres Erscheinungsbild als je zuvor. Ergänzt wird unsere Basis-Alukernplatine durch unsere Passstück LED-Platinen. Diese Passstück LED-Platinen kommen jetzt immer dann zum Einsatz, wenn es darum geht, eine Leuchte mit Sondermaß zu fertigen.

We were able to reduce the pitch again to now only 6.6mm. This allows for a much more uniform appearance than ever before, even in combination with linear lenses. Our basic aluminium core board is complemented by our fitting piece LED boards. These fitting piece LED boards are now always used when a luminaire with special dimensions needs to be produced.

Damit die Effizienz der Leuchten mit Sondermaß nicht zu sehr leidet, haben wir uns für mehrere Passlängen entschieden. Neben des Basis Modullänge von 100 mm gibt es jetzt zudem 60 mm, 40 mm und 20 mm.

To ensure that the efficiency of the luminaires with special dimensions does not suffer too much, we have opted for several installation lengths. In addition to the basic module length of 100 mm, there are now also 60 mm, 40 mm and 20 mm.

Ab sofort werden alle FLASHAAR® LED-Serien auf diese Lösung umgestellt. Egal ob NP Sta.Maria, NP Victory, NP Navigator, NP Jago oder NP Nova.

From now on, all FLASHAAR® LED series will be converted to this solution. No matter whether NP Sta. Maria, NP Victory, NP Navigator, NP Jago or NP Nova.

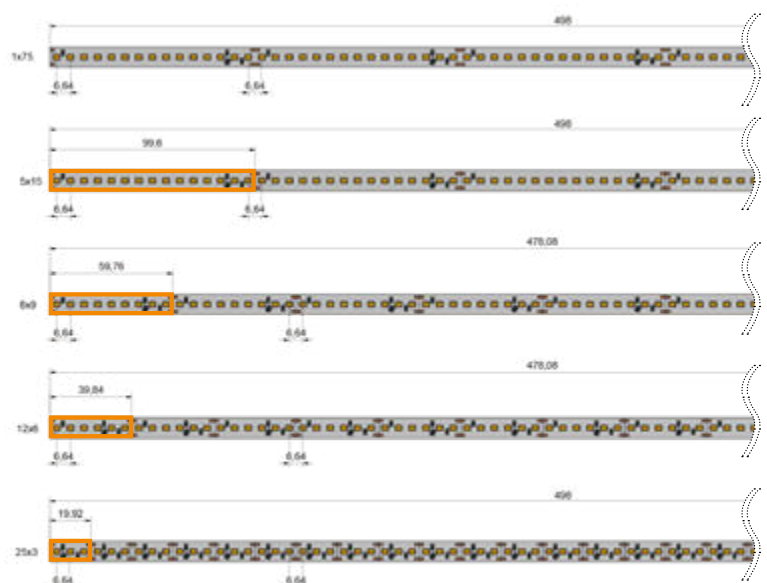
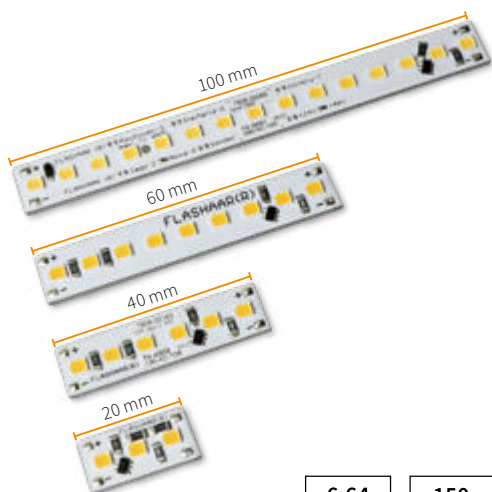



Auf Gehrung geschnittene Leuchten vom Typ NauticProfil® Nova sind bündig in die Treppengeländer der Realschule in Wernau integriert. Sie sorgen für homogenes Licht und Sicherheit auf der Treppe, unterstreichen den Charme der Architektur und werben das Gebäude optisch auf.

Mitre-cut luminaires of the type NauticProfil® Nova, are integrated flush into the stair railings of the secondary school in Wernau. They provide homogeneous light and safety on the stairs, underline the charm of the architecture and visually enhance the building.

Neu bei FLASHAAR®

new at FLASHAAR®



Wir, die FLASHAAR LEDLight GmbH & Co. KG, sind ISO 9001 und ISO 14001 zertifiziert.

We, FLASHAAR LEDLight GmbH & Co. KG, are certified according to ISO 9001 and ISO 14001.

Nach langer Vorbereitung und enormer Fleißarbeit können wir mit Stolz verkünden: Wir haben es geschafft!

DIN ISO 9001 ist ein internationaler Standard für Qualitätsmanagementsysteme, der von der Internationalen Organisation für Normung (ISO) festgelegt wurde. Im Fokus dieser Norm stehen eine Reihe von Leitlinien, die Unternehmen befolgen müssen, um interne Prozesse zu dokumentieren und zu optimieren. Dadurch wird sichergestellt, dass unsere Produkte und Dienstleistungen den stets wachsenden Kundenanforderungen entsprechen und von gleichbleibend hoher Qualität sind. Die ISO-Zertifizierung bestätigt uns, dass wir auf dem richtigen Weg sind.

DIN ISO 14001 ist hingegen eine internationale Umweltmanagementnorm. Sie ist weltweit anerkannt und wird von Organisationen in vielen Ländern, auch in Deutschland, als Maßstab für das Umweltmanagement verwendet. Diese Zertifizierung ist ein Beweis dafür, dass wir uns unserer Verantwortung gegenüber der Umwelt bewusst sind. Wir arbeiten aktiv daran, den Einsatz von Ressourcen zu optimieren und dadurch unsere Nachhaltigkeit zu verbessern.

Neu ist auch, dass nun unser IP PremiumCoating für das NauticProfil® patentiert ist. Bei einem herkömmlichen PU-Überdeckungsverguss (IP65) sind Farbortverschiebungen nicht zu vermeiden. Bei unserem eigens entwickelten, nun patentierten IP PremiumCoating bleibt der Farbort der LED Leuchteneinsätze auch mit PU-Verguss konstant.

Ab sofort verwenden wir für unsere Alu-Profile Hydro REDUXA – ein Aluminium mit einem der weltweit besten Klimabilanzwerte. Wir sind bestrebt unsere Produkte und Materialien stets mit Blick auf den „grünen Fußabdruck“, den wir hinterlassen, zu optimieren. Aluminium ist ein essenzieller Bestandteil unserer Leuchten. Es verfügt neben seiner geringen Dichte, über eine gute Wärmeleitfähigkeit, ist aber leider auch mit hohen CO₂-Emissionen bei der Herstellung verbunden. Hier liefert Hydro REDUXA eine nachhaltigere Lösung. Erneuerbare Energiequellen wie Wasserkraft verringern die CO₂-Bilanz des Aluminiums auf ein Viertel der Werte, die im weltweiten Durchschnitt üblich sind.

After a long preparation and enormous hard work, we can proudly announce: We have made it!

DIN ISO 9001 is an international standard for quality management systems established by the International Organisation for Standardisation (ISO). This standard focuses on a set of guidelines that companies must follow in order to document and optimise internal processes. This ensures that our products and services meet the ever-growing customer requirements and are of consistently high quality. The ISO certification confirms that we are on the right track.

DIN ISO 14001, on the other hand, is an international environmental management standard. It is recognised worldwide and used as a benchmark for environmental management by organisations in many countries, including Germany. This certification proves that we are aware of our environmental responsibility. We are actively working to optimise the use of resources and thus improve our sustainability.

Another new feature is that our IP PremiumCoating is now patented for the NauticProfil®. With conventional PU overlap potting (IP65), colour location shifts cannot be avoided. With our specially developed, now patented IP PremiumCoating, the colour location of the LED luminaire inserts remains constant even with PU potting.

From now on, we use Hydro REDUXA for our aluminium profiles - an aluminium with one of the best climate stability values in the world. We are always striving to optimise our products and materials in terms of the „green-footprint“ we leave behind. Aluminium is an essential component of our luminaires. In addition to its low density, it has good thermal conductivity, but is unfortunately also associated with high CO₂ emissions during production. This is where Hydro REDUXA delivers a more sustainable solution. Renewable energy sources such as hydropower reduce the carbon footprint of aluminium to a quarter of the global average.







In der Skulpturensammlung und Museum für Byzantinische Kunst, gelegen im Humboldt-Forum, lassen sich im neuen Skulpturensaal die ursprünglichen Sandsteifiguren der Schlossfassaden aus der Nähe betrachten. Die in die Voute integrierten FLASHAAR® Leuchten bilden ein weiches Grundlicht und bringen die Erhabenheit des Raumes und deren Exponate zur Geltung.

In the Sculpture Collection and Museum of Byzantine Art, located in the Humboldt Forum, the original sandstone figures of the palace facades can be viewed up close in the new Sculpture Hall. The FLASHAAR® luminaires integrated into the cove create a soft ambient light and bring out the splendour of the room and its exhibits.



Forschung, Entwicklung und Produktion

research, development and production

Wachstum im Einklang mit unserer Umwelt

growth in harmony with our environment

In Bingen am Rhein ist FLASHAAR® als familiengeführtes Unternehmen fest verwurzelt. Forschung und Entwicklung, Vertrieb und Produktion arbeiten unter einem Dach und in engem Austausch. Ihr Vorteil: kompromisslose Fertigungsqualität, Flexibilität bei der Auftragsabwicklung und ein Höchstmaß an Zuverlässigkeit und Liefertreue. Handwerk und modernste Produktionsanlagen, qualifizierte Mitarbeiter und ausgefeilte Prozessabläufe greifen Hand in Hand. Auch unsere Zulieferer kommen zum größten Teil aus Deutschland, Österreich und der Schweiz.

Kurze Lieferketten sind umweltfreundlich, senken Kosten, die mit dem Transport von Waren über große Entfernungen verbunden sind und bieten die Möglichkeit, schnell auf Nachfragen und Änderungswünsche zu reagieren. Im Ergebnis liefern wir projektspezifische Leuchten in gleicher Qualität und Lieferzeit wie Serienprodukte.

Jede Leuchte wird vor der Auslieferung auf Lichtleistung und Qualität geprüft. Unser eigenes Lichtlabor liefert mittels Fernfeld-Goniometer exakte Lichtverteilungskurven. Es gewährleistet kontinuierliche Qualitätssicherung und gibt Rückschlüsse für die ständige Weiterentwicklung und Verbesserung unserer Produkte.

Der Fokus unserer Forschungs- und Entwicklungsaktivitäten liegt auf den Bereichen Energieeffizienz, Lichtqualität und Lichttechnik. Dabei arbeiten wir eng mit Hochschulen zusammen und unterstützen Studierende mit dem Angebot und der Betreuung von Praktika und Abschlussarbeiten.

In der Kombination von wissenschaftlichen Erkenntnissen und modernsten lichttechnischen Komponenten entstehen bei FLASHAAR® langlebige LED-Beleuchtungssysteme – mit ausgezeichnetem Kosten-Nutzen-Verhältnis und Zukunftsgarantie für Ihr Projekt.

FLASHAAR® is a family-run company that is firmly rooted in Bingen am Rhein. Research and development, sales and production work together at a single location and in close consultation with each other. Your benefit: uncompromising production quality, flexible order processing and highest levels of reliability and delivery dependability. Craftsmanship and modern production equipment, qualified staff and sophisticated processes all engage harmoniously with each other. Most of our suppliers also operate from locations within Germany, Austria and Switzerland.

Short supply chains are environmentally friendly, reduce the costs associated with transporting goods over long distances and provide the opportunity to respond quickly to requirements and change requests. The result is that we are able to supply project-specific luminaires in the same quality and delivery times as series-produced luminaires.

The output and quality of each luminaire is tested before delivery. Our own in-house lighting laboratory provides exact light distribution curves using far-field goniometers. The data thus made available makes it possible to implement consistent quality-assurance measures and draw conclusions for the further development and subsequent improvement of our products.

Our research and development activities focus on the fields of energy efficiency, light quality and lighting technology. We work closely here with universities and also support students by offering them practical training and helping them with their graduation theses. Long-lasting LED lighting systems – with outstanding cost-benefit ratios and thus guaranteeing the future of your project – are created at FLASHAAR® through the combination of scientific findings with ultra-modern technical lighting components.



Innovation als Prozess: TOP 100 Innovator 2019 + 2021

Innovation as a process: TOP 100 innovator 2019 + 2021



26. + 28. Ehrung der TOP 100

Unternehmen die ein vorbildliches Innovationsmanagement und überdurchschnittliche Innovationserfolge aufweisen, werden in einer unabhängige Auswahl mit dem TOP 100-Siegel geehrt.

Das TOP 100-Siegel wird in drei Größenklassen vergeben: bis 50 Mitarbeiter, 51 bis 200 Mitarbeiter und mehr als 200 Mitarbeiter. Pro Größenklasse konnten dabei maximal 100 Mittelständler ausgezeichnet werden.

Innovationsforscher Prof. Dr. Nikolaus Franke und sein Team analysierten die Bewerber vor der Vergabe des Siegels anhand von mehr als 100 Leistungsindikatoren in fünf Kategorien.

So legten die Teilnehmer beispielsweise dar, wie innovativ das Top-Management die Prozesse im Unternehmen strukturiert oder auf welche Weise Mitarbeiter ihre innovativen Ideen einbringen können (weitere Infos: www.top100.de/pruef Kriterien).

In einer Sonderkategorie untersuchten die Forscher zudem, wie die Teilnehmer z.B. unternehmerisch auf die Coronakrise reagiert hatten. Franke und sein Team entschieden dann unabhängig darüber, wer das Siegel bekommt.

Verschiedene Kennzahlen zeigen, dass Innovationen sich positiv auf den Unternehmenserfolg auswirken:

So liegt das Umsatzwachstum der Top-Innovatoren 25,7 Prozentpunkte über dem Branchenschnitt. 36,3 Prozent ihres Umsatzes erzielten sie dabei mit Marktneuheiten oder innovativen Verbesserungen. Aufgrund neu entwickelter innovativer Prozesse erzielten die Mittelständler Einsparungen in Höhe von 8,4 Prozent der Gesamtkosten. Ihnen wurden zudem im Zeitraum 2018 bis 2020 1.171 nationale und 2.819 internationale Patente erteilt. Zwei Drittel der TOP 100-Unternehmen sind übrigens familiengeführt.

„Wahre Innovatoren verändern sich ständig, erfinden sich neu und stoßen dabei auf überraschende Lösungen.“

Ranga Yogeshwar

„Innovation bedeutet Unruhe. Die TOP 100-Unternehmen schaffen daher laufend neue Produkte, neue Dienstleistungen, neue Geschäftsmodelle und neue Prozesse. Wer Innovationsführer sein will, muss das Unternehmen als Ganzes konsequent auf das Innovationsziel ausrichten.“

Prof. Dr. Nikolaus Franke

26th + 28th Honours awards of the TOP 100

Companies that demonstrate exemplary innovation management and above-average innovation success are honored with the TOP 100 seal in an independent selection.

The TOP 100 seal was awarded in three size categories: up to 50 employees, 51 to 200 employees and more than 200 employees. A maximum of 100 SMEs per size category were eligible for the award.

Innovation researcher Prof. Dr. Nikolaus Franke and his team analyzed the applicants on the basis of more than 100 performance indicators in five categories before awarding the seal. Participants explained, for example, how innovative top management is in shaping processes in the company or how employees can contribute their innovative ideas (further information: www.top100.de/pruef Kriterien).

In a special category, the researchers also examined how the participants had responded entrepreneurially to the Corona crisis. Franke and his team then independently decided who would receive the seal.

Various key figures show that innovations have a positive impact on the company's success:

The sales growth of the top innovators is 25.7 percentage points above the industry average. They generated 36.3 percent of their sales with market novelties or innovative improvements. Through newly developed innovative processes, SMEs achieved savings of 8.4 percent of total costs. They were also granted 1,171 national and 2,819 international patents between 2018 and 2020. Incidentally, two-thirds of the TOP 100 companies are family-run.

„True innovators are constantly changing, reinventing themselves and coming up with surprising solutions.“

Ranga Yogeshwar

„Innovation means unrest. TOP 100 companies are therefore continually creating new products, new services, new business models and new processes. Whoever wants to be an innovation leader must consistently align the company as a whole with the innovation goal.“

Prof. Dr. Nikolaus Franke





FLASHAAR LEDLight GmbH & Co. KG erhält TOP 100-Siegel FLASHAAR LEDLight GmbH & Co. KG receives TOP 100 seal

FLASHAAR LEDLight GmbH & Co. KG aus Bingen hat bei der 26. und 28. Ausgabe des Innovationswettbewerbs TOP 100 erneut den Sprung unter die Besten geschafft.

Im Auftrag von compamedia, dem Ausrichter des Innovationswettbewerbs TOP 100, untersuchten der Innovationsforscher Prof. Dr. Nikolaus Franke und sein Team die Innovationskraft von FLASHAAR®. Die Forscher legten rund 120 Prüfkriterien aus fünf Kategorien zugrunde: Innovationsförderndes Top-Management, Innovationsklima, Innovative Prozesse und Organisation, Außenorientierung/Open Innovation und Innovationserfolg.

In dem unabhängigen Auswahlverfahren überzeugten wir bereits zum zweiten Mal mit unserem Innovationserfolg.

Wir, die FLASHAAR LEDLight GmbH & Co. KG, sind in der Planung und Entwicklung von LED-Leuchten beheimatet. Unser Unternehmen hat sich vor allem durch die Entwicklung eines Systembaukastens für lineare LED-Leuchten, dem NauticProfil® System, einen Namen gemacht. Dank des NauticProfil® Systems lassen sich alle Komponenten, wie Linsen, Cover, Profile und Platinen, in unzähligen Varianten untereinander kombinieren. Für das NP System spricht die unkomplizierte Planung, die Plug&Play Installation ohne aufwendige Verkabelung und das Markenzeichen „Made in Germany“.

Zu finden sind die Präzisionslösungen auch in Gebäuden, die ihre Reputation in besonderer Weise zum Leuchten bringen – beispielsweise in der Hamburger Elbphilharmonie, dem Kultur- und Kongresszentrum Liederhalle in Stuttgart oder im Humboldt-Forum in Berlin.

FLASHAAR LEDLight GmbH & Co. KG from Bingen has once again made it to the top of the 26th and the 28th edition of the TOP 100 innovation competition.

On behalf of compamedia, the organizer of the TOP 100 innovation competition, innovation researcher Prof. Dr. Nikolaus Franke and his team investigated the innovative strength of FLASHAAR®. The researchers used around 120 test criteria from five categories: Innovation-promoting top management, innovation climate, innovative processes and organization, external orientation/open innovation and innovation success.

In the independent selection process, we were convinced for the second time with our innovation success.

FLASHAAR LEDLight GmbH & Co. KG is at home in the planning and development of LED luminaires. Our company has made a name for itself primarily through the development of a modular system for linear LED luminaires, the NauticProfil® system. Thanks to the NauticProfil® system, all components, such as lenses, covers, profiles and circuit boards, can be combined with each other in countless variations. The uncomplicated planning, the Plug&Play installation without complex wiring and the trademark „Made in Germany“ speak for the NP system.

The precision solutions can also be found in buildings that live up to their reputation in a special way - for example, the Elbphilharmonie in Hamburg, the Liederhalle Culture and Congress Center in Stuttgart, or the Humboldt Forum in Berlin.



2007

Swen Flashaar-Bloedorn nimmt als Geschäftsführer der FLASHAAR LED-Light GmbH & Co. KG die Produktion eigener LED-Leuchten auf. Die Manufaktur für innovative LED-Technologien schafft mit Erfindergeist und modernster Technik Beleuchtungslösungen von kompromissloser Qualität.

Swen Flashaar-Bloedorn starts manufacturing LED luminaires as the CEO of FLASHAAR LEDLight GmbH & Co. KG. The manufactory for innovative LED technologies creates lighting solutions of uncompromising quality with an inventive spirit and state-of-the-art technology.

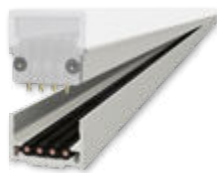

2009

Das NauticProfil® wird zum Patent angemeldet – ursprünglich für den Einsatz im Yachtbau konzipiert, hat es sich als Systembaukasten für anspruchsvolle Beleuchtungen im Innen- und Außenbereich etabliert.

The NauticProfil® patented – originally designed for use in yacht building, it has now become established as a modular system for sophisticated indoor and outdoor lighting.

2013

Leuchten vom Typ FLASHAAR® High-PowerProfil-2 illuminieren das Hofbräuhaus, eines der bekanntesten Wahrzeichen Münchens.

FLASHAAR® HighPowerProfil-2 luminaires installed in the Hofbräuhaus – one of Munich's most famous landmarks.

2014

Öffentliche Einrichtungen, Geschäftsräume und Privathäuser – zahlreiche Architekten und Lichtplaner setzen auf das NauticProfil®.

Facilities, commercial premises and private homes – many architects and lighting designers are turning to NauticProfil® for their lighting solutions.

2015

Ausbau der Fertigungskapazität mit einer NC-gesteuerten Untertisch-Kapp- und Gehrungssäge und einer CNC-Bohrfräsmaschine.

Production capacities are expanded with an NC-controlled undertable cross-cut and mitre saw and CNC drilling-and-milling machine.

2017

FLASHAAR LEDLight feiert: Zehn Jahre erfolgreich am Markt. Im Jubiläumsjahr wird die Elbphilharmonie in Hamburg eröffnet – und FLASHAAR® Lichtlinien und Spots lenken die Blicke der Besucher u.a. auf die weltweit einzigartige Orgel sowie auf über 800 Stufen im Großen Saal.

FLASHAAR LEDLight celebrates 10 years of success in the market. In the anniversary year, the Elbe Philharmonic Hall in Hamburg opens – and FLASHAAR® light lines and spotlights draw the attention of visitors to the unique organ, the central acoustic reflector and the 800 steps in the Great Hall.

2018

Anschaffung einer fast 8 m² großen CNC Portalfräse zur 2,5 D Bearbeitung von Leuchtgehäusen. Damit können mehrere Teile gleichzeitig, präzise und schnell bearbeitet werden. Eine wichtige Voraussetzung für die Serienproduktion.

Acquisition of a nearly 8 m² large CNC portal milling machine for the 2.5 D machining of luminaire housing. This allows multiple parts to be processed simultaneously, precisely and quickly. An important prerequisite for series-production.

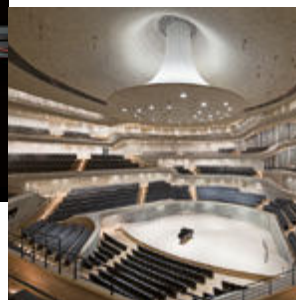

2016

FLASHAAR® richtet ein eigenes Lichtlabor mit Fernfeld-Goniometer ein und bietet zu allen Leuchten exakte lichttechnische Daten an.

FLASHAAR® sets up its own inhouse lighting laboratory with far-field goniometer equipment and is now able to provide precise technical lighting details for all its luminaires.

2019

Auszeichnung

FLASHAAR® gehört zu den TOP 100! Wir, die FLASHAAR LEDLight GmbH & Co. KG aus Bingen, haben bei der 26. Ausgabe des Innovationswettbewerbs Top 100, den Sprung unter die Besten geschafft.

Award

FLASHAAR® ranks among the TOP 100 FLASHAAR LEDLight GmbH & Co. KG from Bingen has taken its place among the best in both the 26th edition of the TOP 100 innovation competition.



2020

FLASHAAR® PremiumCoating wird zum Patent angemeldet.

Das eigens entwickelte Vergussverfahren für unsere NauticProfil® Leuchten-einsätze, ermöglicht die Lieferung von Leuchten für den Innen- und Außenbereich mit exakt dem gleichen Farbort.

FLASHAAR® PremiumCoating is patent pending. The specially developed potting process for our NauticProfil® light inserts makes it possible to supply luminaires for indoor and outdoor use with exactly the same colour location.

2021

Preisgekrönte Innovationskraft:

FLASHAAR LEDLight GmbH & Co. KG gehört zu den TOP 100 – und das nun schon zum zweiten Mal.

In einem so außergewöhnlichen Jahr wie diesem, freuen wir uns umso mehr über diese besondere Auszeichnung.

Award-winning innovation:

FLASHAAR LEDLight GmbH & Co. KG is one of the TOP 100 – and this for the second time. In such an extraordinary year as this one, we are all the more pleased about this special award.

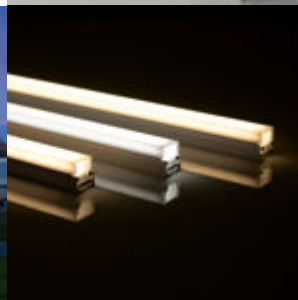

2021

Das Humboldt Forum im Berliner Schloss erstrahlt mit Leuchten von FLASHAAR®.

Insgesamt beleuchten über 1,1 km lineare Leuchten von FLASHAAR® die Sammlungen sowie Bereiche des Schlosses.

The Humboldt Forum in the Berlin Palace shines with luminaires from FLASHAAR®.

In total, over 1.1 km of linear luminaires from FLASHAAR illuminate the collections and areas of the palace.

2022

FLASHAAR® investiert in eine neue Vergussanlage von DEMAK. Die CNC Dosiermaschine ist mit Vakuumtanks ausgestattet und verfügt über einen automatisierten Vergussfahrweg von 3000x500 mm. Sie wurde speziell für den hochwertigen LED-Verguss mit Polyurethan angefertigt. Unterschiedliche Vergussfarben und Härtegrade, von weich, kratzfest bis glashart, sind dank der neuen Vergussanlage kein Problem mehr.

FLASHAAR® invests in a new potting machine from DEMAK. The CNC dispensing machine is equipped with 6 vacuum tanks and has an automated potting travel of 3000 x 500 mm. It was specially made for high-quality LED potting with polyurethane. Different potting colours and degrees of hardness, from soft, scratch-resistant to glass-hard, are no longer a problem thanks to the new potting system.

2023

ENEC Zertifizierung

für unsere FLASHAAR® DB-Bahnsteigleuchte - eine Einbauleuchte mit integrierten Solaris-2 LED Spots

ENEC certification

for our FLASHAAR® DB platform luminaire - a recessed luminaire with integrated Solaris-2 LED spots



2023

FLASHAAR® ist DIN ISO 14001 + DIN ISO 9001 zertifiziert

Darauf sind wir stolz! Es gibt uns die Möglichkeit, unsere Umweltverantwortung besser wahrzunehmen, den Einsatz von Ressourcen zu optimieren und dadurch unsere Nachhaltigkeit zu verbessern. Gleichzeitig können wir unseren Kunden und Partnern garantieren, dass wir zuverlässig hochwertige und geprüfte Produkte, in gewohnt gleichbleibender Qualität liefern.

FLASHAAR® is DIN ISO 14001 + DIN ISO 9001 certified

This is something we are proud of! It allows us to fulfill our environmental responsibilities better, optimize resource use, and improve our sustainability. At the same time, we can guarantee our customers and partners that we reliably deliver high-quality and tested products, in the usual consistent quality.





FLASHAAR NauticProfil®

+	NP Line Sta. Maria-6	Muster
-	FLNP/L/01E	/
-	Base code	Length Light colour Cover & Lens
	0510	/830

Voltage
Power
IP rating
Binning:



(V): 48V SELV
W): 4,8 W
IP40
7GB

Test 24h:
DC: AC:
PWM dimmable:
Date: 07/2022

CE 2022

Made in Germany

Unser NauticProfil® System
our NauticProfil® system

NauticProfil® System – ein Klick, viele Lösungen

NauticProfil® System – one click, many solutions

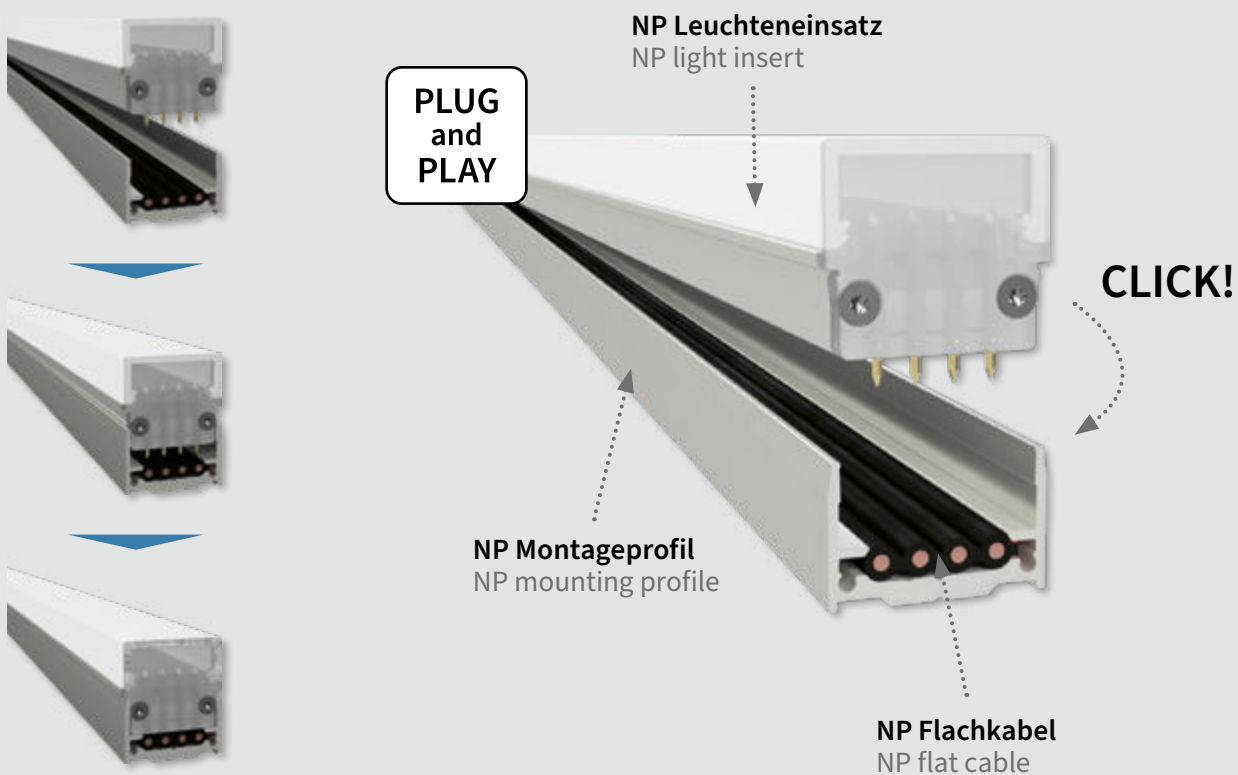

vielseitig | zuverlässig | bewährt | robust | einzigartig
versatile | reliable | proven | robust | unique

Unser patentiertes NauticProfil® (NP) System – unser FLASHAAR® Kernprodukt – steht für Freiheit beim Gestalten mit Licht:

Aus den NP Montageprofilen, NP Leuchteinsätzen und einer Vielzahl von LED-Serien, optischen Systemen sowie dem passenden Zubehör, entstehen Lichtlinien und Einzellichter für zahlreiche Anwendungsbereiche und Installationssituationen. Allen gemeinsam: unkomplizierte Planung, Plug&Play Installation ohne aufwendige Verkabelung und Qualität „Made in Germany“.

In den NP Montageprofilen verläuft ein Flachkabel, in das die komplett vormontierten Leuchteinsätze mit ihren Piercing-Kontakten „eingeklickt“ werden. Genauso einfach ist auch der Austausch, sollten sie einmal ersetzt werden. Mit verschiedenen Optiken und Adaptern für Strahler lässt sich das NauticProfil® an wechselnde Anforderungen anpassen. Auch für sehr lange Lichtlinien mit nur einer elektrischen Einspeisung bietet es hervorragende Voraussetzungen.

Our patented NauticProfil® (NP) System – FLASHAAR's core product – gives users the freedom to design with light:

The NP mounting profiles, NP LightInserts, a range of LED series, optical systems and matching accessories may be used to create lines of light and individual luminaires to be employed in a broad range of applications and installation situations. And common to them all: quality „Made in Germany“, uncomplicated planning and Plug&Play installation without complex wiring.

The mounting profiles contain flat cables into which the fully pre-assembled light inserts with their piercing contacts are „clicked“ into place. Replacing luminaires when necessary is just as easy. With different optics and adapters for spotlights, the NauticProfil® can be adapted to changing requirements. NauticProfil® also makes it possible to install very long lines of light that require only one electric feed.



NauticProfil® lineare Leuchteinsätze liefern vielseitige, lineare Lichtlösungen mit universellen Lichteigenschaften, Optiken, Covern und Linsen.

NauticProfil® linear light inserts provide versatile linear lighting solutions with universal lighting properties, optics, covers and lenses.

ab Seite / from page **78**



NauticProfil® Focus Leuchteinsätze sind, dank Präzisionslinsen und HighPower LEDs, die beste Wahl für lichtstarke, hochwertige und fokussierte Anwendungen.

The NauticProfil® Focus light inserts are, thanks to precision lenses and HighPower LEDs, the best choice for bright, high-quality and focused applications.

ab Seite / from page **144**



NauticProfil® PicoSpot Leuchteinsätze sind smart konstruiert und bieten eine Vielzahl an Möglichkeiten unterschiedlicher Akzentbeleuchtung.

NauticProfil® PicoSpot light inserts are smartly designed and offer a variety of different accent lighting options.

ab Seite / from page **173**



NauticProfil® Montageprofile sind aus hochwertigem Aluminium und bewähren sich in zahlreichen Installationssituationen und Projekten.

NauticProfil® mounting profiles are made of high-quality aluminium and have proven themselves in numerous installation situations and projects.

ab Seite / from page **31**



NauticProfil® Blind ist eine hochwertige Profilabdeckung, die u.a. auch als Kabelkanal zum Einsatz kommt.

NauticProfil® Blind is a high-quality profile cover that is also used as a cable duct, among other things.

ab Seite / from page **140**



NauticProfil® Flachkabel und weiteres NP Montagezubehör runden das Portfolio ab und ermöglichen eine individuelle Freiheit beim Gestalten mit Licht.

NauticProfil® flat cable and other NP mounting accessories round off the portfolio and allow individual freedom when designing with light.

ab Seite / from page **197**



NauticProfil® Extensions ermöglichen eine flexible Beleuchtung, durch schwenkbare Lichtlinien, die sich von -105° bis $+105^\circ$ neigen lassen.

NauticProfil® Extensions allows flexible lighting thanks to the swivelling light lines that can be tilted from -105° to $+105^\circ$.

ab Seite / from page **74**



NauticProfil® Sonderanfertigungen, Kleinserien oder umfangreiche Projekte – profitieren Sie von unserem Know-how und unserer Erfahrung.

NauticProfil® custom-made products, small series or extensive projects - benefit from our know-how and experience.

ab Seite / from page **183**

NauticProfil® System – so funktioniert es

NauticProfil® System – how it works

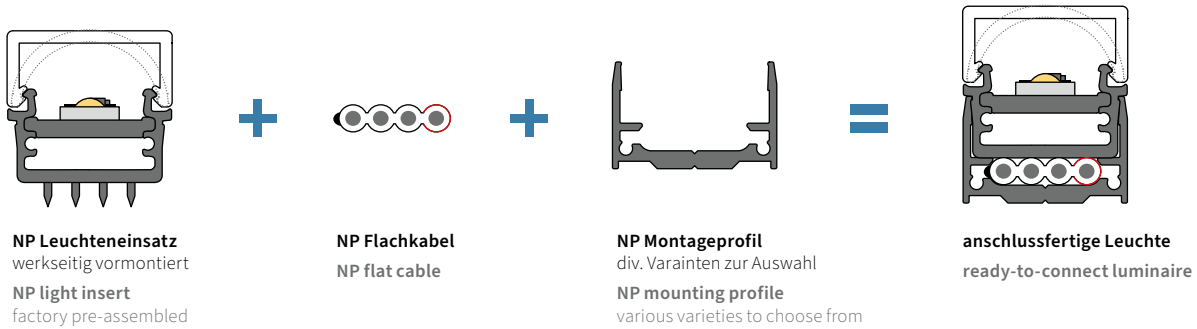

NauticProfil® (NP) Leuchteneinsatz

NauticProfil® (NP) light insert

ab Seite / from page **78**

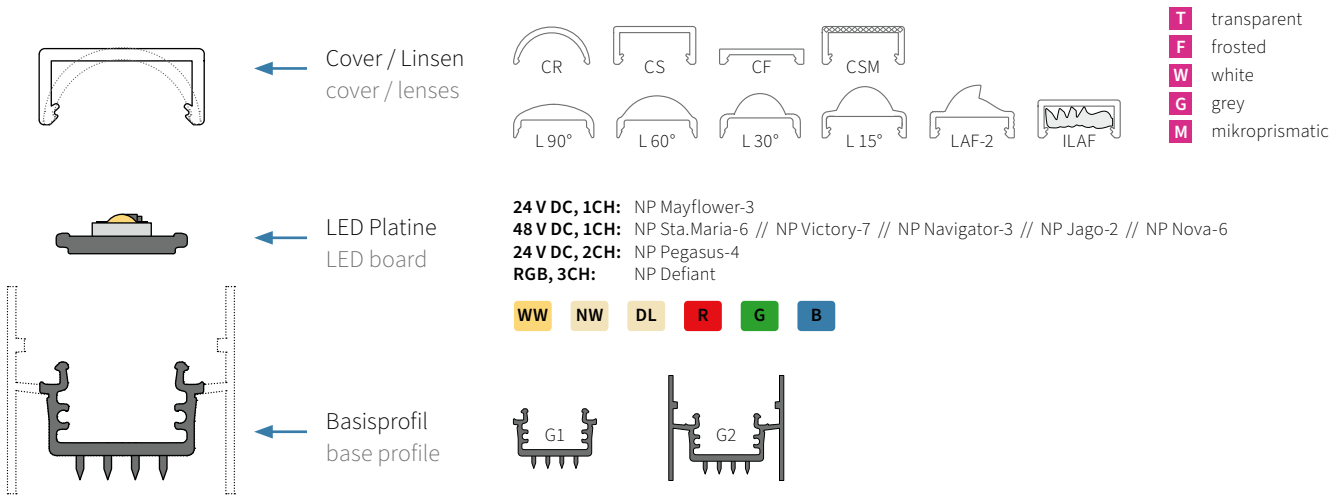

NauticProfil® (NP) Montageprofile

NauticProfil® (NP) mounting profiles

ab Seite / from page **31**

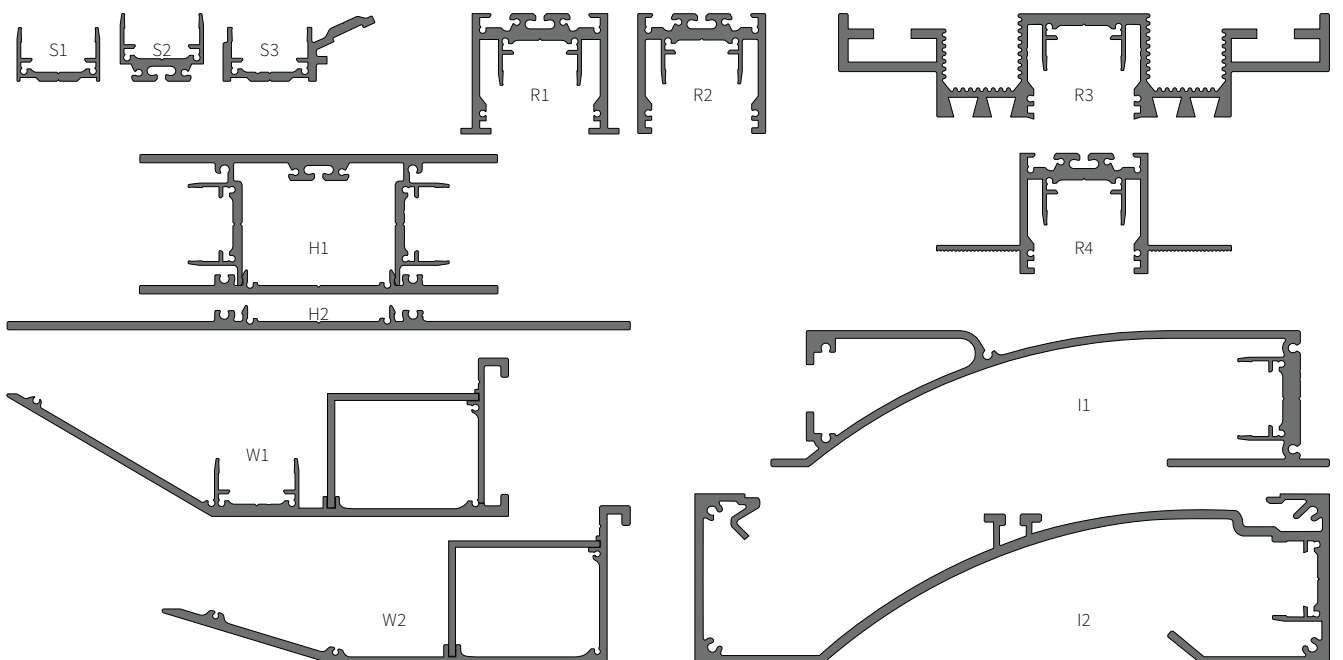

Unser Artikelnummern-System einfach erklärt

our item number system simply explained

NP/L1C/06F/G1 / L1C/G1/112 / G1/ ALA / 8 27 / CR W

NP/L1C/06F/G1	→	NauticProfil® / Lineare Leuchte 1CH / Leuchtentyp (Bsp. Nova-6) / Basisprofil G1 NauticProfil® / linear luminaire 1CH / luminaire type (Bsp. Nova-6) / base profile G1
L1C/G1/112	→	Länge des 1CH Leuchtenkörpers mit Endkappe in mm length of 1CH lamp unit with endcaps in mm
G1/ALA	→	Farbe des Basisprofils G1 (Bsp. ALA = Aluminiumfarben) colour of base profile G1 (ex. ALA = aluminium colours)
8 27	→	CRI (Bsp. typ. 85) + Lichtfarbe (Bsp. 2700 K) CRI (ex. typ. 85) + light colour (ex. 2700 K)
CR W	→	Cover (Bsp. cover round) + Coverfarbe (Bsp. weiß) cover (ex. cover round) + cover colour (ex. white)

Sonstige Begriffe und Bezeichnungen erklärt

other terms and designations explained

NP	NauticProfil®
IP40	Die Schutzart IP40 besagt, dass die Leuchte gegen das Eindringen fester Fremdkörper des Durchmessers 1 mm und grösser geschützt ist. Nicht gegen Wasser geschützt. Protection class IP40 means that the luminaire is protected against the ingress of solid foreign bodies of a diameter of 1 mm and larger. Not protected against water.
IP65	Die Schutzart IP65 besagt, dass die Leuchte vollständig gegen Berührung, gegen Staubeintritt sowie gegen Strahlwasser geschützt ist. Sie darf nicht unter Wasser getaucht werden! ⚠ Achtung! Unsere Leuchten sind nur bis zu einer Länge von 1008 mm in IP65 lieferbar! Protection class IP65 means that the luminaire is fully protected against contact, dust ingress, and water jets. It must not be submerged in water! ⚠ Attention! Our luminaires are only available up to a length of 1008 mm in IP65!
IP65P patentiert patented	Das für unser NauticProfil® patentierte IP65 PremiumCoating hat eine zusätzliche Schutzabdeckung direkt über der LED-Alukernplatte, um eine Farbortverschiebung zu vermeiden. Die Leuchten erfüllen alle Vorgaben der Schutzart IP65. The IP65 PremiumCoating patented for our NauticProfil® has an additional protective cover directly above the LED aluminium core board to prevent colour location shift. The luminaires meet all the specifications of protection class IP65.



Forum Schwanthalerhöhe, München

Nach einer grundlegenden Sanierung und konzeptionellen Überarbeitung der Immobilie aus den 70er Jahren, laden nun über 90 verschiedene Shops und Restaurants zum Einkaufen und Verweilen ein.

NP Sta. Maria und NP Focus Leuchten betonen dezent die hochwertige Außenfassade aus Faserbetonelementen. Auch in der Passage findet man zahlreiche Lichtlinien von FLASHAAR®, wie zum Beispiel in den Rolltreppen, den Fluren oder als indirekte Vouten-Beleuchtung in den Deckenfeldern.

After a thorough refurbishment and conceptual overhaul of the property from the 1970s, over 90 different shops and restaurants now invite visitors to shop and linger. NP Sta. Maria and NP Focus luminaires discreetly accentuate the high-quality exterior façade made of fibre concrete elements. Numerous light lines from FLASHAAR® can also be found in the passage, for example in the escalators, the corridors or as indirect cove lighting in the ceiling panels.





NauticProfil® Montageprofile und Optionen NauticProfil® mounting profiles and options

Die NauticProfil® Montageprofile sind Eigenentwicklungen unseres Unternehmens – entstanden aus langjähriger Erfahrung und bewährt in zahlreichen Projekten. Mit Hohlräumen für die Aufnahme von Kabeln und Betriebsgeräten, einfacher Zugänglichkeit und mehreren Optionen für die Montage sind sie bis ins Detail durchdacht. Die hochwertigen Aluminiumprofile werden in Deutschland und Österreich exklusiv für FLASHAAR® hergestellt.

Zuschnitt und Verarbeitung – auf Maß für Ihr Projekt

Unsere Produktion am Standort Bingen bietet zahlreiche Optionen für die Verarbeitung der Profile für Ihr Projekt – sprechen Sie mit unserem Vertriebs-Team über Ihre Vorstellungen.

Alle Profile liefern wir zugeschnitten auf Maß oder in der transportoptimierten Standardlänge von 2010 mm. Maximal können Profile in 6000 mm Länge geliefert werden, um bei sichtbaren Anwendungen die Zahl der Ansätze zu reduzieren.

Auf Wunsch werden alle Profile auch auf Gehrung zugesägt – zum Beispiel in L-, U- oder Q-Konfiguration – und mit Bohrungen und Ausfräsungen versehen.

The range of NauticProfil® mounting profiles was developed by FLASHAAR® itself – from many years of experience and tried-and-tested in many projects. With cavities for cables and controllers, easy access and multiple fitting options, they have been thought through right down to the final detail. The high-quality aluminium profiles are manufactured exclusively for FLASHAAR® in Germany and Austria.

Cut and tailored specifically to your requirements

Our production facility in Bingen is equipped to realise a broad range of options for your project – talk to our sales team about your ideas.

All profiles may be supplied in the desired sizes or in the transport-optimised standard length of 2010 millimetres. Profiles in lengths of up to 6000 millimetres are also available for the purposes of reducing the number of connections in visible applications.

All profiles may also be cut at angles on request – for example, in L, U or Q configurations – and manufactured with holes and cut-outs.

NauticProfil® Montageprofile – Übersicht im Maßstab 1:1

NauticProfil® mounting profiles – overview at the scale 1:1

NauticProfil® (NP) – Serie S
NauticProfil® (NP) – series S

ab Seite from page **38**

NP S1

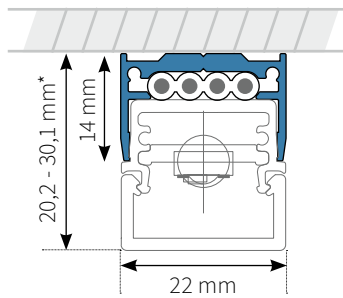

NP S2

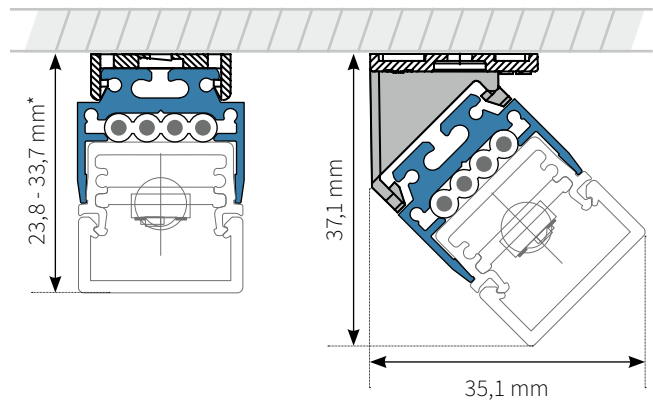

NP S3

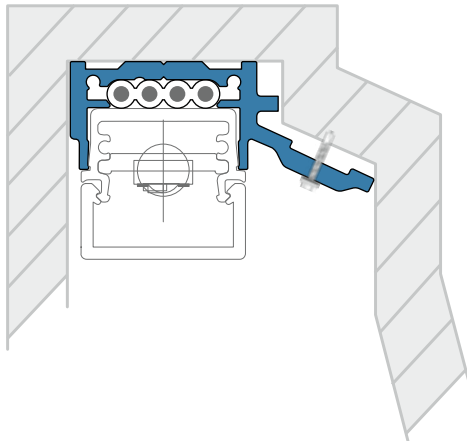

* Die Höhe ist abhängig von der gewählten Konfiguration.
* The height depends on the selected configuration.

NP H1

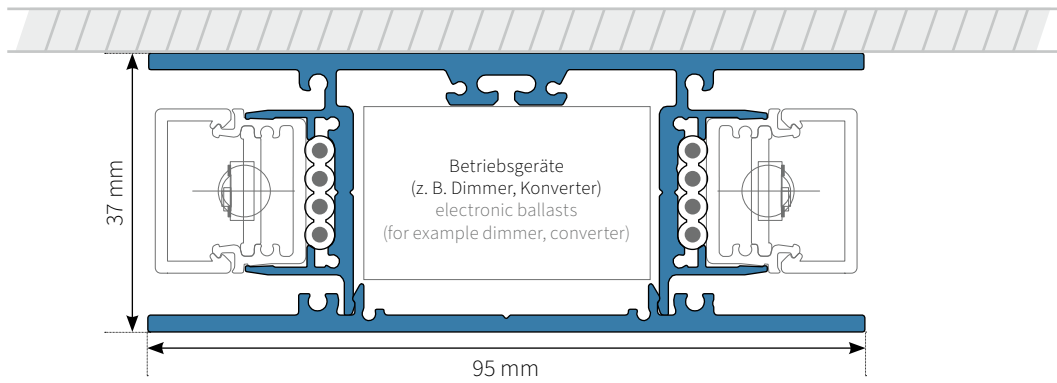

NP H2

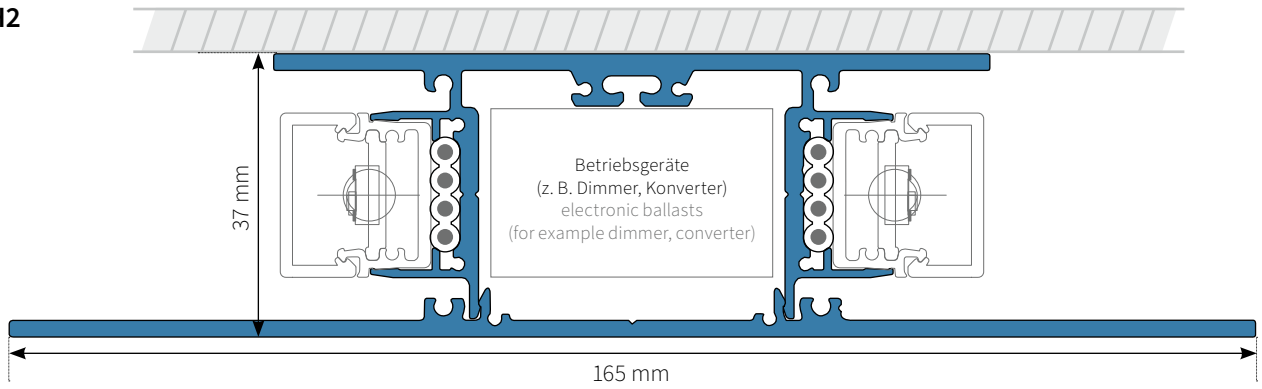

NP R1

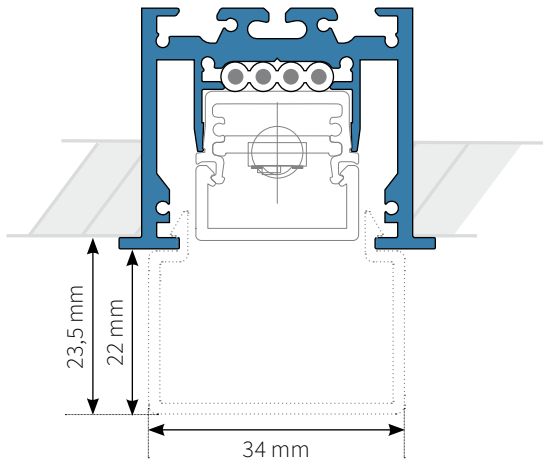

NP R2

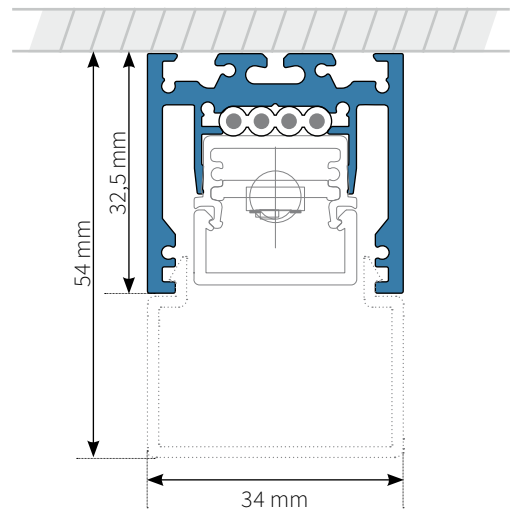

NP R3

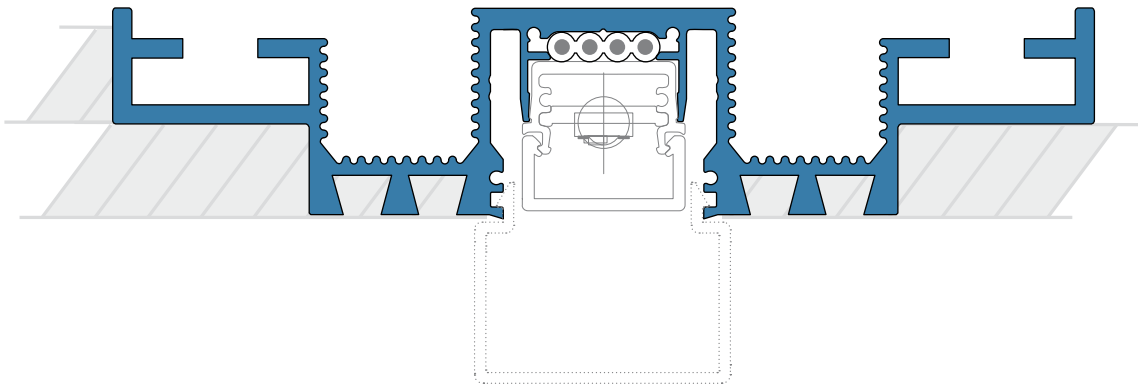

NP R4

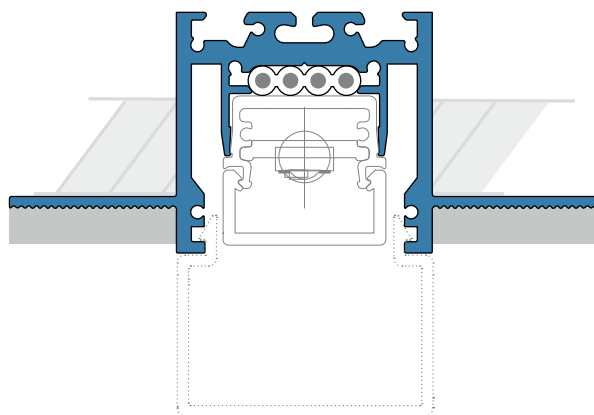

NP I1

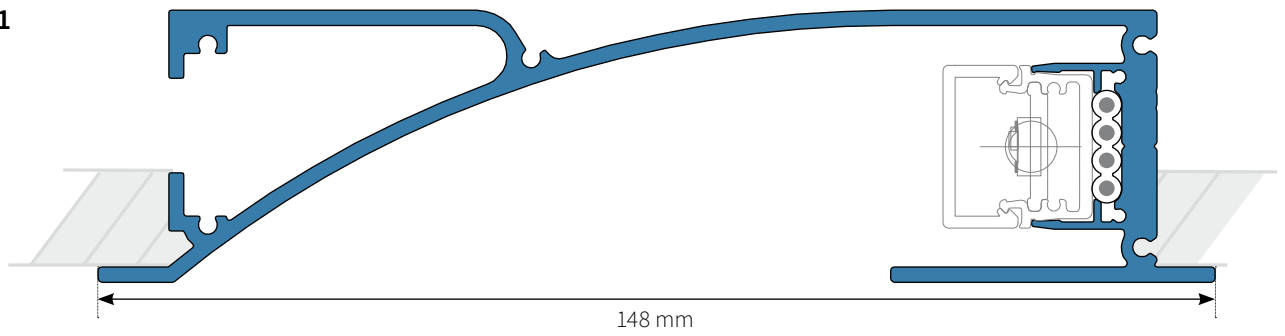

NP I2

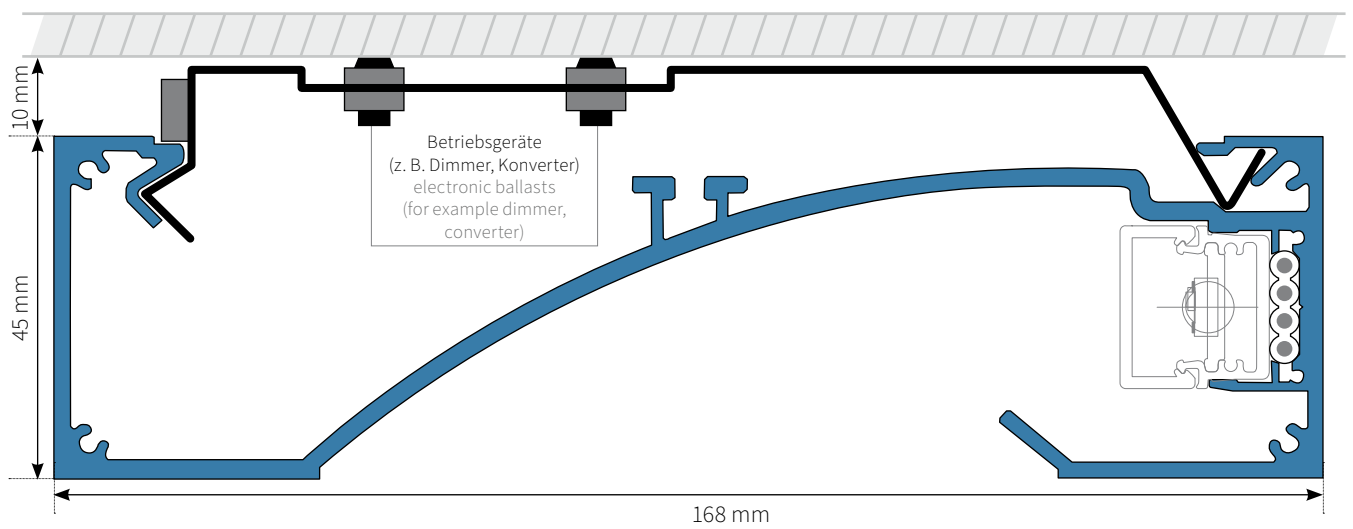

NP W1

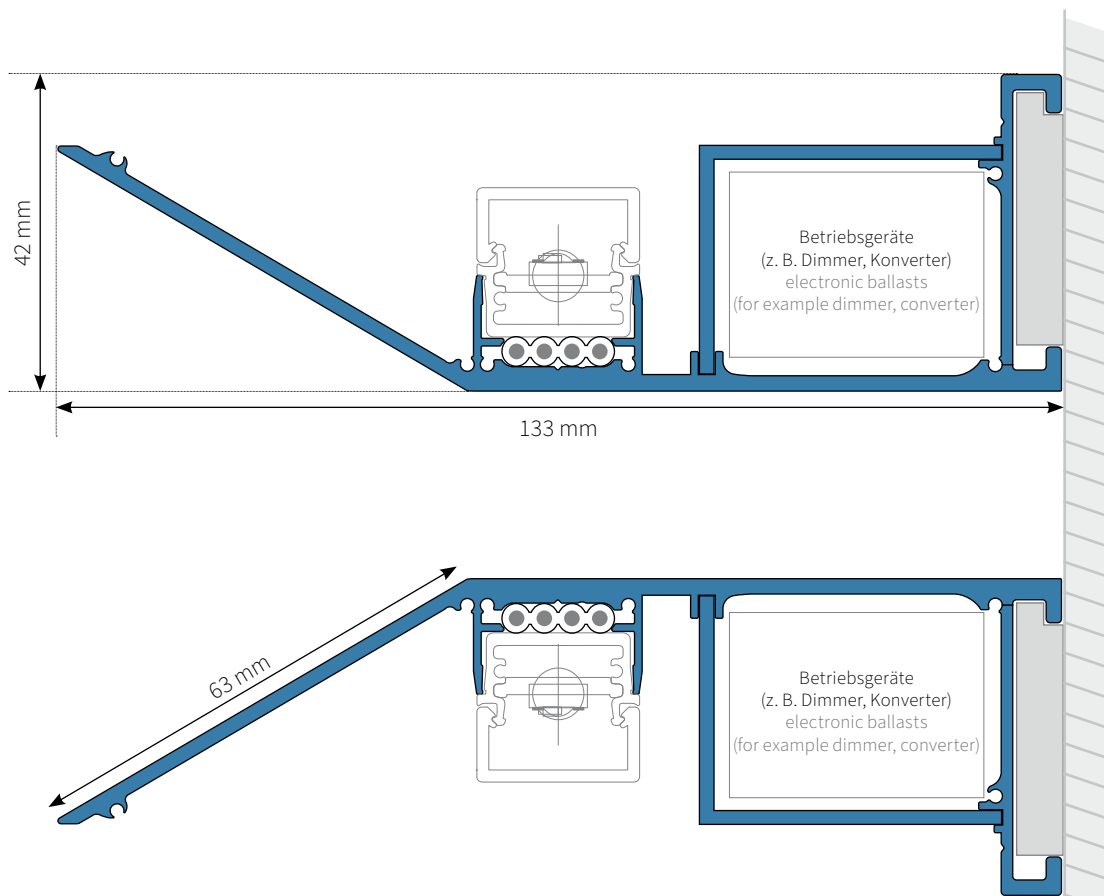

NP W2

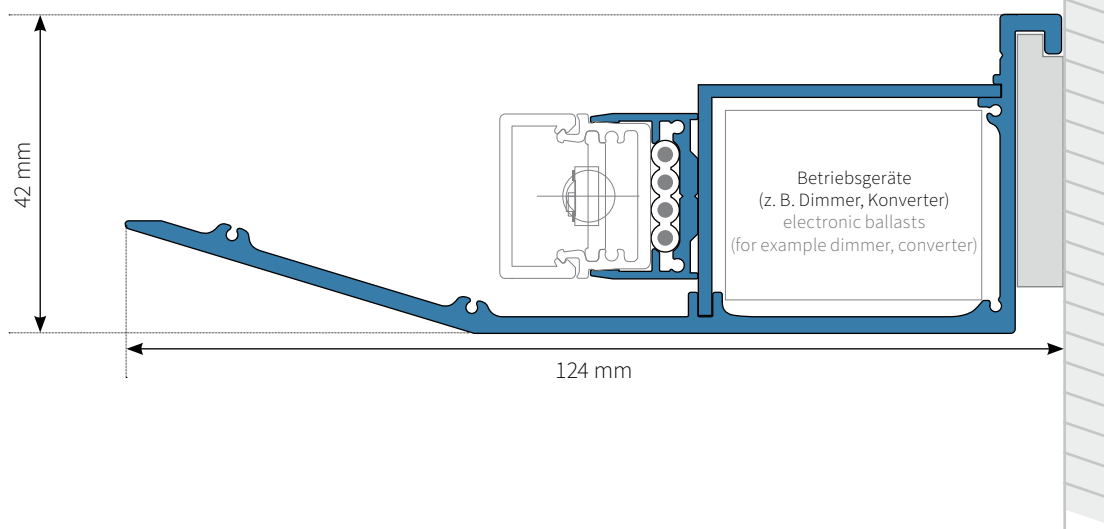



NauticProfil® Montageprofile
NauticProfil® mounting profiles

NP S1

Der Klassiker für lange Lichtlinien und filigrane Leuchten

Unser **NauticProfil® S1** ist ein schlankes Aufbauprofil und bildet zusammen mit dem NP Leuchteneinsatz eine optische Einheit mit dekorativen Seitenflächen.

Das Profil eignet sich hervorragend für den Anbau an Wand und Decke oder für elegante Pendelleuchten. Als Einbauprofil lässt es sich perfekt in kleinste Hohlräume integrieren, zum Beispiel in Handläufen oder Möbeln.

Am Boden des Profils befindet sich alle 150 mm ein Montageloch, welches ein einfaches Befestigen ermöglicht. Zusätzlich können mittels einer Zentrierlinie ganz einfach weitere Löcher ohne Körnung oder Verrutschen in den Boden des Profils gebohrt werden.



The classic for long lines of light and filigree luminaires

Our **NauticProfil® S1** is a slender surface-mounted profile that creates a visual unit with decorative sides when used in conjunction with the NP LightInsert.

The profile is highly suited for mounting on the surfaces of walls and ceilings and for elegant pendant luminaires. As a recessed profile, it can be perfectly integrated into the smallest of cavities, e.g. in handrails or items of furniture. For mounting there is a hole in an distance of 150 mm. The auxiliary line in the profile allows drilled additional holes without grain.



TIPP

Im Profilboden sind Montagelöcher aller 150 mm. Die Zentrierlinie im Boden des Profils ermöglicht das Bohren zusätzlicher Löcher ohne Verrutschen.

The bottom of the profile has holes every 150 mm. The auxiliary line in the profile allows drilled additional holes without grain.

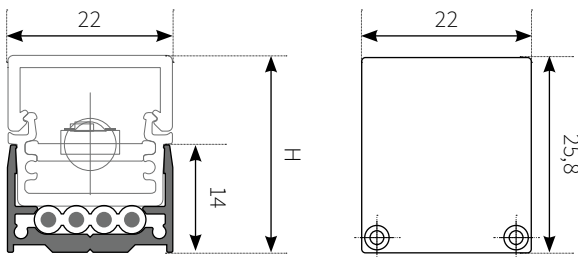

NP Endplatte für S1, S2, S3
NP end plate for S1, S2, S3

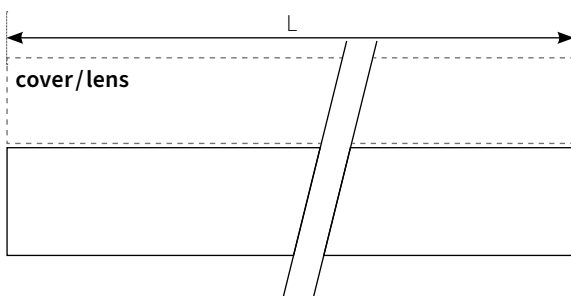

Maßstab 1:1 / Alle Maßangaben in mm.
scale 1:1 / All dimensions in mm.

Bitte bei NP Profil- und Endplatten-Bestellung die Art.Nr. um die gewünschte Farbe ergänzen. Bei gewünschtem Gehrungsschnitt die Art.Nr. um die Gradzahl, bei Bestellung des NP Flachkabels die Art.Nr. um die entsprechende Länge (mm) ergänzen. Bitte beachten Sie unser Formular für NauticProfil® Eck-Konfigurationen im Katalog und unter www.flashaar.de

cover / lenses	B x H (mm)
CR (cover round)	22 x 26,8
CS (cover square)	22 x 26,1
CF (cover flat)	22 x 20,2
L9 (lens 90°)	22 x 24,1
L6 (lens 60°)	22 x 26,2
L3 (lens 30°)	22 x 26,7
L1 (lens 15°)	22 x 30,1
LAF-2 (lens asymmetric)	22 x 30,0
CSB (cover square blind)	22 x 26,2

... /ALA
alu anodized (standard)
E6EV1

... /BA
black anodized
E6C14

... /TWP
RAL 9016 traffic white
fine structure (powdered)

Sonderfarben auf Anfrage! Special colours on request!

Please state the required colour with the article number when ordering NP profiles and end plates. Please state the required angle with the article number when ordering bevel cuts and state the corresponding length (mm) with the article number when ordering NP flat cables. Please take note of our form for NauticProfil® corner-connections and also at www.flashaar.de



© My Cloud Hotel, Frankfurt / Hering Sanikonzzept GmbH

Bestellnummer
item number

NP/S1-MP / 2010 / ###

Aufhängung
suspension



Symbolbild
symbolic

NP/PENDANT2

Stahlseilabhängung und Anschlussleitung
(ohne Baldachin)
steel pendant set and connection cable
(without canopy)



Symbolbild
Symbolic

FLNP/PENDANT3

Stahlseilabhängung und Anschlussleitung
mit Deckenbefestigung (Baldachin),
Kabellänge ohne Werkzeug variabel
einstellbar
steel pendant and connection line with
ceiling attachment (canopy), cable length
can variably be adjusted without tools

Artikel, Zubehör und Optionen
articles, accessories and options



NP/S1-MP/2010/###

(0510 /1010 /2010 oder 3020 x 22 x 14 mm)
NP-S1 Aluminium Montageprofil
NP-S1 aluminium mounting profile

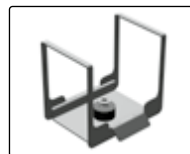

FLNP/S1-MP/SC

(31,1 x 35 x 23,5 mm)
NauticProfil® Sicherheitsklammer für NP-S1
NauticProfil® safety clip for NP-S1



FLNP/S1-EP/###

(2 x 22,6 x 25,8 mm) ohne Kabelauslass/
without cable release
Aluminium Endplatte für NP-S1/-S2/-S3 Montageprofil
aluminium end plate for NP-S1/-S2/-S3 mounting profile

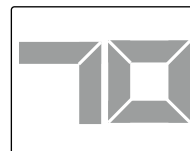

FL/B-CUT

Gehrungsschnitt für L-, U- oder Q-Konfiguration
bevel cut for L-, U- or Q-configuration



FLNP/S1-EP/2/###

(2 x 22,6 x 25,8 mm) mit Kabelauslass/
with cable release
Aluminium Endplatte für NP-S1/-S2/-S3 Montageprofil
aluminium end plate for NP-S1/-S2/-S3 mounting profile



FLNP/FCable-UV

(4x2,5/3,45 mm² / 0,122 kg/m)
NP Flachkabel 4 x 2,5mm², UV-beständig
NP flat cable 4 x 2,5mm², UV resistant

NP S2

Optimal für Objekt- und Fassadenbeleuchtung

Für das **NauticProfil® S2** haben wir unser bewährtes NP S2 um eine Aufnahme für Montageclips erweitert. Diese sind in verschiedenen Ausführungen und mit oder ohne Winklung erhältlich – perfekt für symmetrische und asymmetrische Lichtlinien und Leuchten, für Objektbeleuchtungen und Wallwasher.

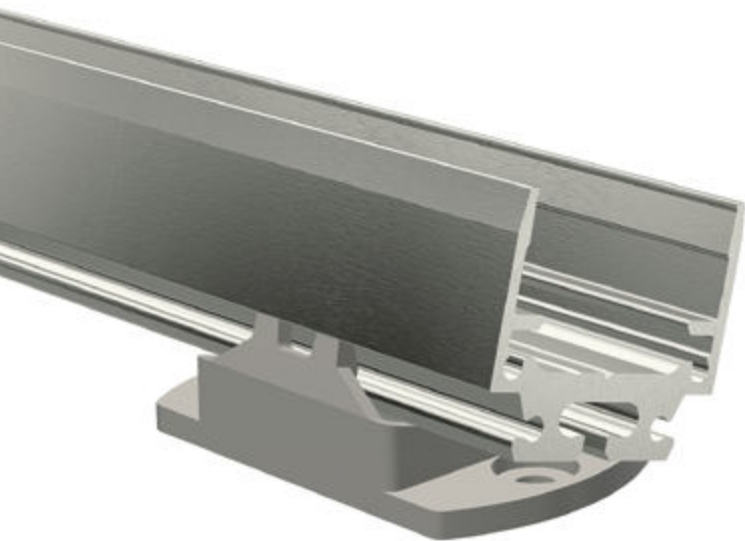

Perfect for illuminating buildings and facades

We have added a holding fixture for mounting clips to our tried-and-tested **NauticProfil® S2** product for the NP S2. These are available in different versions and with or without angles – perfect for symmetrical and asymmetrical lines of light and luminaires, for illuminating buildings and wall washers.

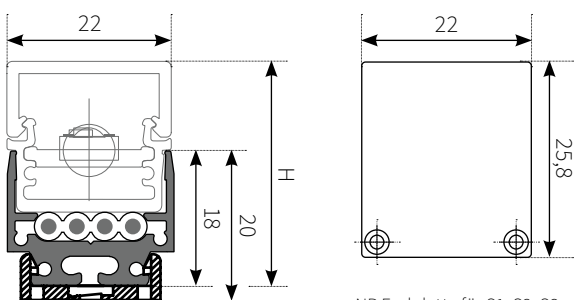
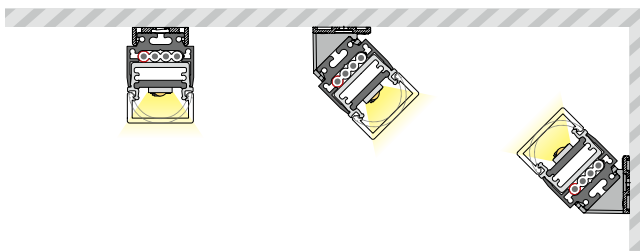

NP Endplatte für S1, S2, S3
NP end plate for S1, S2, S3

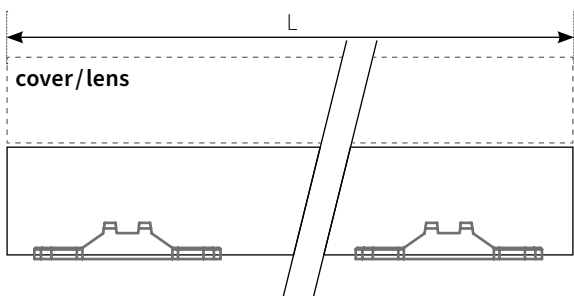

cover/lenses	B x H (mm)
CR (cover round)	22 x 30,4
CS (cover square)	22 x 29,7
CF (cover flat)	22 x 23,8
L9 (lens 90°)	22 x 27,7
L6 (lens 60°)	22 x 29,8
L3 (lens 30°)	22 x 30,3
L1 (lens 15°)	22 x 33,7
LAF-2 (lens asymmetric)	22 x 33,6
CSB (cover square blind)	22 x 29,7

 .../ALA
alu anodized (standard)
E6EV1

 .../BA
black anodized
E6C14

 .../TWP
RAL 9016 traffic white
fine structure (powdered)

Maßstab 1:1 / Alle Maßangaben in mm.
scale 1:1 / All dimensions in mm.

Bitte bei NP Profil- und Endplatten-Bestellung die Art.Nr. um die gewünschte Farbe ergänzen. Bei gewünschtem Gehrungsschnitt die Art.Nr. um die Gradzahl, bei Bestellung des NP Flachkabels die Art.Nr. um die entsprechende Länge (mm) ergänzen. Bitte beachten Sie unser Formular für NauticProfil® Eck-Konfigurationen im Katalog und unter www.flashaar.de

Sonderfarben auf Anfrage! Special colours on request!

Please state the required colour with the article number when ordering NP profiles and end plates. Please state the required angle with the article number when ordering bevel cuts and state the corresponding length (mm) with the article number when ordering NP flat cables. Please take note of our form for NauticProfil® corner-connections and also at www.flashaar.de



© LAPP GmbH, Stuttgart / Ernesto Martens

Bestellnummer
item number

NP/S2-MP / 2010 / ###

Befestigung
fasteners

Auswahl
selection



FL/SCLIP-0/0/001
24 x 18 x 5,8 Federstahl Federclip 0°, 1 Stk.
stainless spring steel spring clip 0°, 1 pc.



FL/CLIP-Adjustable
(35,5 x 19 x 22 mm) Federstahl
verstellbarer Montagewinkel 75° zu beiden Seiten
stainless spring steel adjustable mounting clip 75° on
both sides



⚠ Weitere Informationen zu den Befestigungen finden Sie in unserem Katalog.
You'll find more information about fasteners in our catalogue.

Artikel, Zubehör und Optionen
articles, accessories and options



NP/S2-MP/2010/###
(0510 / 1010 / 2010 oder 3020 x 22 x 18 mm)
NP-S2 Aluminium Montageprofil
NP-S2 aluminium mounting profile

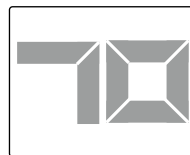

FL/B-CUT
Gehrungsschnitt für L-, U- oder Q-Konfiguration
bevel cut for L-, U- or Q-configuration



FLNP/S1-EP/###
(2 x 22,6 x 25,8 mm) ohne Kabelauslass/
without cable release
Aluminium Endplatte für NP-S1/-S2/-S3 Montageprofil
aluminium end plate for NP-S1/-S2/-S3 mounting profile



FLNP/FCable-UV
(4x2,5/3,45 mm²/0,122 kg/m)
NP Flachkabel 4 x 2,5 mm², UV-beständig
NP flat cable 4 x 2,5 mm², UV resistant



FLNP/S1-EP/2/###
(2 x 22,6 x 25,8 mm) mit Kabelauslass/
with cable release
Aluminium Endplatte für NP-S1/-S2/-S3 Montageprofil
aluminium end plate for NP-S1/-S2/-S3 mounting profile

NP S3

Lange LED-Lichtlinien werden perfekt in Fassaden integriert

Die Serie **NauticProfil® S3** ist eine Sonderanfertigung und eignet sich perfekt zur Integration in Fassaden.

Mit dem NP S3 lassen sich Lichtlinien mit einer Gesamtlänge von bis zu 120 Metern aus einer einzigen elektrischen Einspeisung realisieren – und das zu einem erstklassigen Preis-Leistungs-Verhältnis sowie mit bis zu drei Lichtkreisen.

Long LED light lines are perfectly integrated into facades

The **NauticProfil® S3** series is a special design that is perfect for very high-quality contour and accent lighting. This NP S3 makes it possible to realise lines of light in total lengths of up to 120 metres from a single electrical feed – and to do so at a first-class price-performance ratio and up to three light circuits.

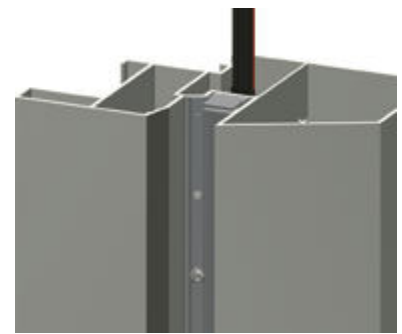

beispielhafte Anwendung
exemplary application

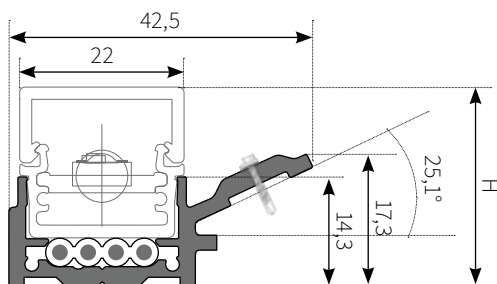

Für H siehe Tabelle bei NP-S1, S. 37 (H = max. 34 mm)
For H see table at NP-S1, p. 37 (H = max. 34 mm)

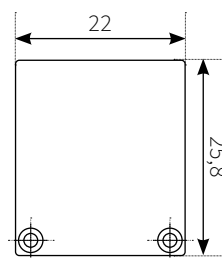

NP Endplatte für S1, S2, S3
NP end plate for S1, S2, S3

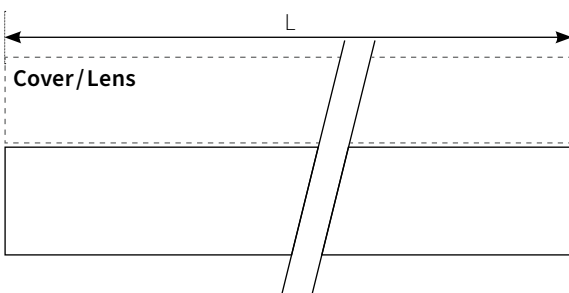
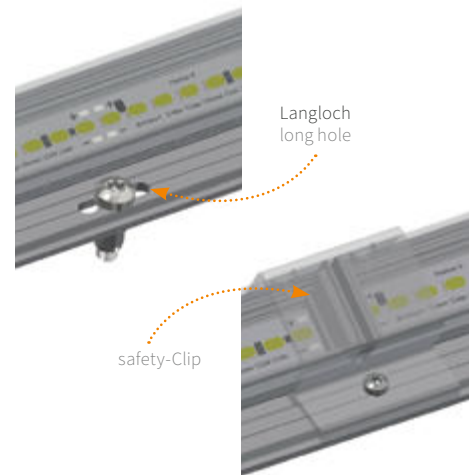

 .../ALA
alu anodized (standard)
E6EV1

 .../BA
black anodized
E6C14

 .../TWP
RAL 9016 traffic white
fine structure (powdered)

Maßstab 1:1 / Alle Maßangaben in mm.
scale 1:1 / All dimensions in mm.

Bitte bei NP Profil- und Endplatten-Bestellung die Art.Nr. um die gewünschte Farbe ergänzen. Bei gewünschtem Gehrungsschnitt die Art.Nr. um die Gradzahl, bei Bestellung des NP Flachkabels die Art.Nr. um die entsprechende Länge (mm) ergänzen. Bitte beachten Sie unser Formular für NauticProfil® Eck-Konfigurationen im Katalog und unter www.flashaar.de

Sonderfarben auf Anfrage! Special colours on request!

Please state the required colour with the article number when ordering NP profiles and end plates. Please state the required angle with the article number when ordering bevel cuts and state the corresponding length (mm) with the article number when ordering NP flat cables. Please take note of our form for NauticProfil® corner-connections and also at www.flashaar.de



Bestellnummer
item number

NP/S3-MP / 2010 / ###

Befestigung
fasteners

Langloch mit Gewindebohrung für die Aufnahme der Linsenschraube mit Unterlegscheibe und Sicherungsring. Diese Schrauben dienen zur Montage der Leuchte an den Fassadenprofilen mit den bauseitig angebrachten Blindnietmutter. Nachdem die Schrauben in das Gewinde eingesetzt wurden, sind sie unverlierbar, ein Entfernen aus dem Langloch ist nur durch Herausdrehen aus dem Gewindegang möglich. Innerhalb des Langlochs sind die Schrauben jedoch frei bewegbar. Die Leuchte wird vormontiert, mit eingesetzten Schrauben geliefert. Der Safety-Clip – zur Sicherung der NP Leuchteneinsätze – verhindert, dass diese nach dem Lösen aus dem Profil herausfallen.

Langloch mit Gewindebohrung für die Aufnahme der Linsenschraube mit Unterlegscheibe und Sicherungsring. Diese Schrauben dienen zur Montage der Leuchte an den Fassadenprofilen mit den bauseitig angebrachten Blindnietmutter. Nachdem die Schrauben in das Gewinde eingesetzt wurden, sind sie unverlierbar, ein Entfernen aus dem Langloch ist nur durch Herausdrehen aus dem Gewindegang möglich. Innerhalb des Langlochs sind die Schrauben jedoch frei bewegbar. Die Leuchte wird vormontiert, mit eingesetzten Schrauben geliefert. Der Safety-Clip – zur Sicherung der NP Leuchteneinsätze – verhindert, dass diese nach dem Lösen aus dem Profil herausfallen.

Artikel, Zubehör und Optionen
articles, accessories and options



NP/S3-MP/2010/###
(0510 /1010 /2010 oder 3020 x 42,5 x 14,3 mm)
NP-S1 Aluminium Montageprofil
NP-S1 aluminium mounting profile



FL/PC/###
Safety-Clip, Schutzhülle
protective cover



FLNP/S1-EP/###
(2 x 22,6 x 25,8 mm) ohne Kabelauslass/
without cable release
Aluminium Endplatte für NP-S1/-S2/-S3 Montageprofil
aluminium end plate for NP-S1/-S2/-S3 mounting profile

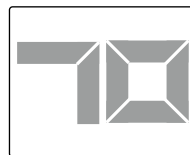

FL/B-CUT
Gehrungsschnitt für L-, U- oder Q-Konfiguration
bevel cut for L-, U- or Q-configuration



FLNP/S1-EP/2/###
(2 x 22,6 x 25,8 mm) mit Kabelauslass/
with cable release
Aluminium Endplatte für NP-S1/-S2/-S3 Montageprofil
aluminium end plate for NP-S1/-S2/-S3 mounting profile



FLNP/FCable-UV
(4x2,5/3,45 mm² / 0,122 kg/m)
NP Flachkabel 4 x 2,5 mm², UV-beständig
NP flat cable 4 x 2,5 mm², UV resistant





Die abendliche Akzentbeleuchtung des **Schulcampus „An der Dällt“**, hebt die Form der Gebäude künstlerisch hervor - ein Konzept der FLASHAAR Ingenieure. Verschiedene Lichtszenarien sind programmiert und können je nach Anlass oder Veranstaltung den Campus variantenreich in Szene setzen.

The evening accent lighting of the **school campus „An der Dällt“**, artistically highlights the shape of the buildings - a concept by FLASHAAR engineers. Various lighting scenarios are programmed and can set the campus in scene in a variety of ways depending on the occasion or event.

NP H1

Zweiseitig abstrahlende Wand- oder Pendelleuchte

Lange Lichtlinien mit zweiseitiger Abstrahlung an Decken und Wänden oder schicke Pendellösungen mit direkter / indirekter Beleuchtung – dafür ist das **NauticProfil® H1** perfekt geeignet. Die komplett abnehmbare Frontfläche ermöglicht eine einfache und sichere Anbringung und Verkabelung. Im Profil ist Platz für die verdeckte Unterbringung der Betriebsgeräte, wie Konverter und Dimmer.

Bi-directional wall or pendant luminaire

Long lines of light with bi-directional beam for ceilings and walls or smart pendant solutions with direct or indirect lighting – that's what the **NauticProfil® H1** was specifically designed for. The front cover, which may be removed completely, makes fitting and cabling simple and safe. The profile contains space for the concealed accommodation of controllers.





TIPP

Die Frontfläche kann komplett werkzeu-
los montiert werden.
**drücken-klicken-
fertig**

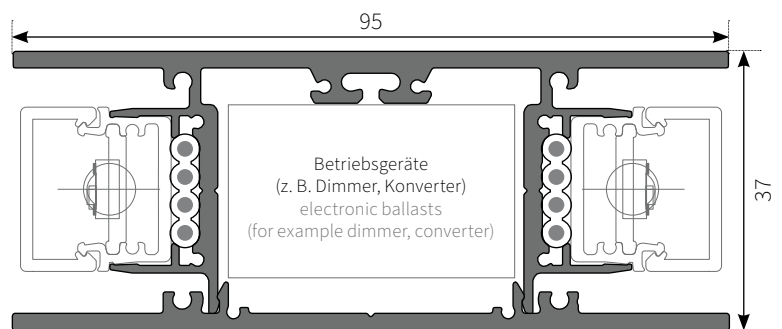
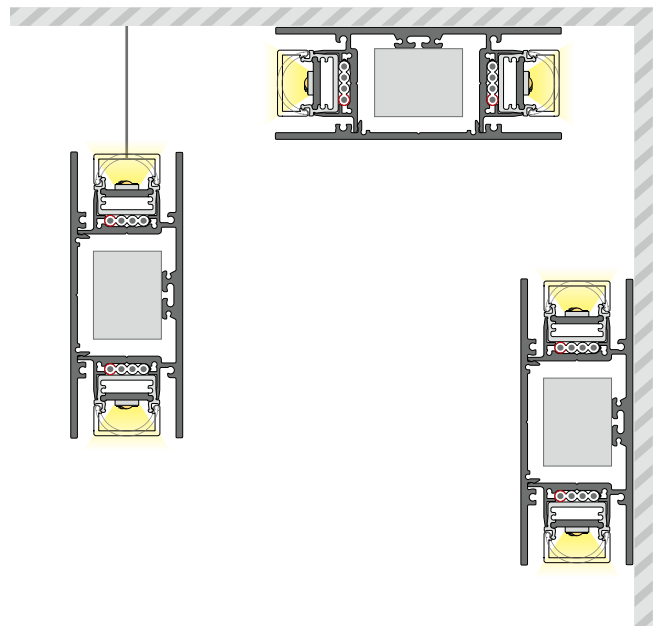
The front cover can
completely be re-
moved without tools.
press-click-done



 .../ALA
alu anodized (standard)
E6EV1

 .../BA
black anodized
E6C14

 .../TWP
RAL9016 traffic white
fine structure (powdered)

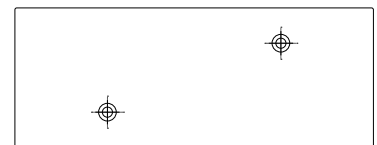

Endplatte NP H1; Maßstab 1:2
end plate NP H1; scale 1:2

Sonderfarben auf Anfrage! Special colours on request!

Bitte bei NP Profil- und Endplatten-Bestellung die Art.Nr. um die gewünschte Farbe ergänzen. Bei gewünschtem Gehrungsschnitt die Art.Nr. um die Gradzahl, bei Bestellung des NP Flachkabels die Art.Nr. um die entsprechende Länge (mm) ergänzen. Bitte beachten Sie unser Formular für NauticProfil® Eck-Konfigurationen im Katalog und unter www.flashaar.de

Maßstab 1:1 / Alle Maßangaben in mm.
scale 1:1 / All dimensions in mm.

Please state the required colour with the article number when ordering NP profiles and end plates. Please state the required angle with the article number when ordering bevel cuts and state the corresponding length (mm) with the article number when ordering NP flat cables. Please take note of our form for NauticProfil® corner-connections and also at www.flashaar.de



© Porcelanosa / Timo Müller / LuMetix GmbH

Bestellnummer
item number

NP/H1-MP / 2010 / ###

Aufhängung
suspension



Symbolbild
symbolic

NP/PENDANT2

Stahlseilabhängung und Anschlussleitung
(ohne Baldachin)
steel pendant set and connection cable
(without canopy)



Symbolbild
symbolic

FLNP/PENDANT3

Stahlseilabhängung und Anschlussleitung
mit Deckenbefestigung (Baldachin),
Kabellänge ohne Werkzeug variabel
einstellbar

steel pendant and connection line with
ceiling attachment (canopy), cable length
can variably be adjusted without tools

Artikel, Zubehör und Optionen
articles, accessories and options



NP/H1-MP/2010/###

(0510 /1010 /2010 oder 3020 x 37 x 95 mm)
NP-H1 Aluminium Montageprofil
NP-H1 aluminium mounting profile

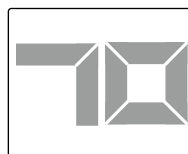

FL/B-CUT

Gehrungsschnitt für L-, U- oder Q-Konfiguration
bevel cut for L-, U- or Q-configuration



FLNP/H1-EP/OA/###

(2 x 37 x 95 mm)
Aluminium Endplatte für NP-H1* Montageprofil
aluminium end plate for NP-H1* mounting profile



FLNP/FCable-UV

(4x2,5/3,45 mm²/0,122 kg/m)
NP Flachkabel 4 x 2,5mm², UV-beständig
NP flat cable 4 x 2,5mm², UV resistant

* Alternative Varianten auf Anfrage
alternative variants on request

NP H2

Zweiseitig strahlende Wandleuchte für blendfreies, homogenes Stimmungslicht

Das **NauticProfil® H2** verfügt, gegenüber dem NP H1, über eine breitere Frontabdeckung, die für eine absolut blendfreie Abstrahlung sorgt. Sie lässt zudem Platz für individuelle Gravuren, Aufdrucke und Folierungen oder eignet sich ideal zum Aufbringen von Spiegelementen und anderen Designobjekten. Auch beim NP H2 ist die Frontabdeckung abnehmbar und ermöglicht eine unkomplizierte Montage und Verkabelung. Im Profil ist Raum für die Unterbringung der Betriebsgeräte, wie Konverter und Dimmer.

Double-sided distribution wall luminaire for glare-free, homogeneous mood lighting

Compared to the NP H1, the **NauticProfil® H2** has a wider front cover, which ensures glare-free radiation. It also leaves room for individual engravings, imprints and foiling or is ideal for applying mirror elements and other design objects. The front cover of the NP H2 is also removable and enables uncomplicated mounting and wiring. There is space in the profile to accommodate the control gear, such as converters and dimmers.





TIPP

Die Frontfläche kann komplett werkzeuglos montiert werden.
drücken-klicken-fertig

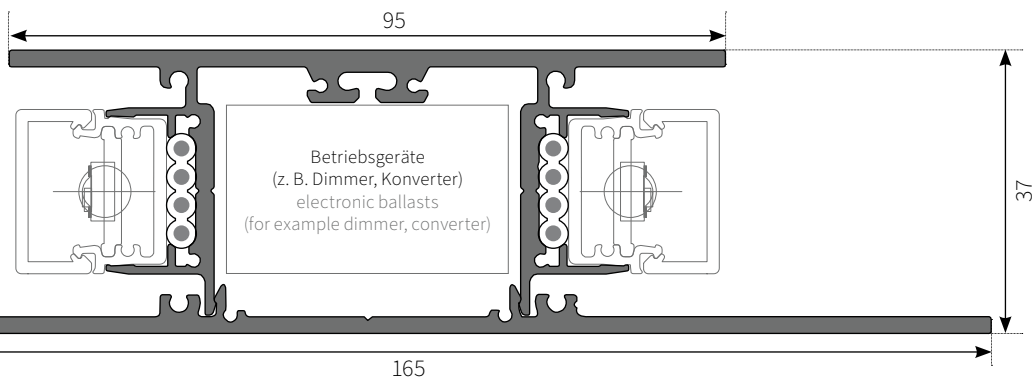
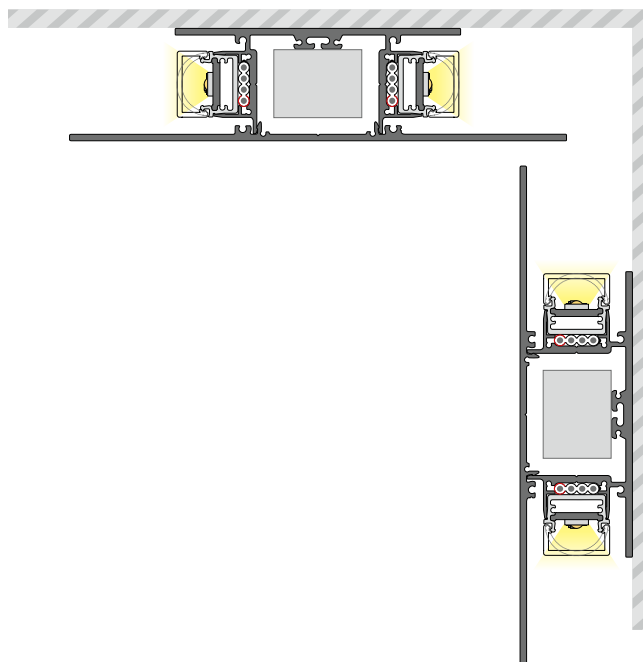
The front cover can completely be removed without tools.
press-click-done



 .../ALA
alu anodized (standard)
E6EV1

 .../BA
black anodized
E6C14

 .../TWP
RAL9016 traffic white
fine structure (powdered)

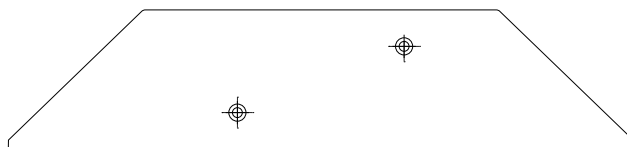

Endplatte NP H2; Maßstab 1:2
end plate NP H2; scale 1:2

Sonderfarben auf Anfrage! Special colours on request!

Bitte bei NP Profil- und Endplatten-Bestellung die Art.Nr. um die gewünschte Farbe ergänzen. Bei gewünschtem Gehrungsschnitt die Art.Nr. um die Gradzahl, bei Bestellung des NP Flachkabels die Art.Nr. um die entsprechende Länge (mm) ergänzen. Bitte beachten Sie unser Formular für NauticProfil® Eck-Konfigurationen im Katalog und unter www.flashaar.de

Maßstab 1:1 / Alle Maßangaben in mm.
scale 1:1 / All dimensions in mm.

Please state the required colour with the article number when ordering NP profiles and end plates. Please state the required angle with the article number when ordering bevel cuts and state the corresponding length (mm) with the article number when ordering NP flat cables. Please take note of our form for NauticProfil® corner-connections and also at www.flashaar.de

FEUERWEHR BINGEN 1973 - 2020



© Sonderanfertigung / FLASHAAR®

Bestellnummer
item number

NP/H2-MP / 2010 / ###

Artikel, Zubehör und Optionen
articles, accessories and options

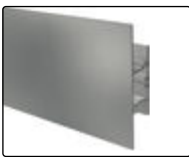

NP/H2-MP/2010/###
(0510 / 1010 / 2010 oder 3020 x 37 x 165 mm)
NP-H2 Aluminium Montageprofil
NP-H2 aluminium mounting profile



FLNP/H2-EP/DOA/###
(37 x 165 x 2 mm)
Alu. Endplatte für NP-H2 Montageprofil mit Lichtfalle
alu. end plate for NP-H2 mounting profile with light trap



FLNP/H2-EP/S/L/###
(37 x 165 x 2 mm)
Aluminium Endplatte für NP-H2 Montageprofil (links)
aluminium end plate for NP-H2 mounting profile
over all (left)

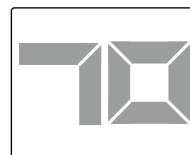

FL/B-CUT
Gehrungsschnitt für L-, U- oder Q-Konfiguration
bevel cut for L-, U- or Q-configuration



FLNP/H2-EP/S/R/###
(37 x 165 x 2 mm)
Aluminium Endplatte für NP-H2 Montageprofil
(rechts)
aluminium end plate for NP-H2 mounting profile
over all (right)



FLNP/FCable-UV
(4x2,5/3,45 mm² / 0,122 kg/m)
NP Flachkabel 4 x 2,5 mm², UV-beständig
NP flat cable 4 x 2,5 mm², UV resistant

* Alternative Varianten auf Anfrage
alternative variants on request



Stimmungsvolle und wegweisende Beleuchtung

Neben neuen Mastleuchten sorgen unsere NP Sta. Maria-5 LED Linien in den Handläufen, an den Rändern der Gustav-Mahler-Treppe in Kassel, für Sicherheit durch eine funktionale, gleichmäßige Beleuchtung. Dank der hohen Lichtqualität bei geringem Lumenstrom schaffen unsere LED-Leuchten nicht nur eine stimmungsvolle Atmosphäre, sie sind auch langlebig und energiesparend – im wahrsten Sinne „wegweisend“

Atmospheric and pioneering lighting

In addition to new pole lights, our NP Sta. Maria-5 LED lines in the handrails, at the edges of the Gustav-Mahler, provide safety through functional, uniform illumination. Thanks to the high quality of light with low lumen output, our LED luminaires not only create an atmospheric ambience, but are also long-lasting and energy-saving - „pioneering“ in the truest sense of the word.

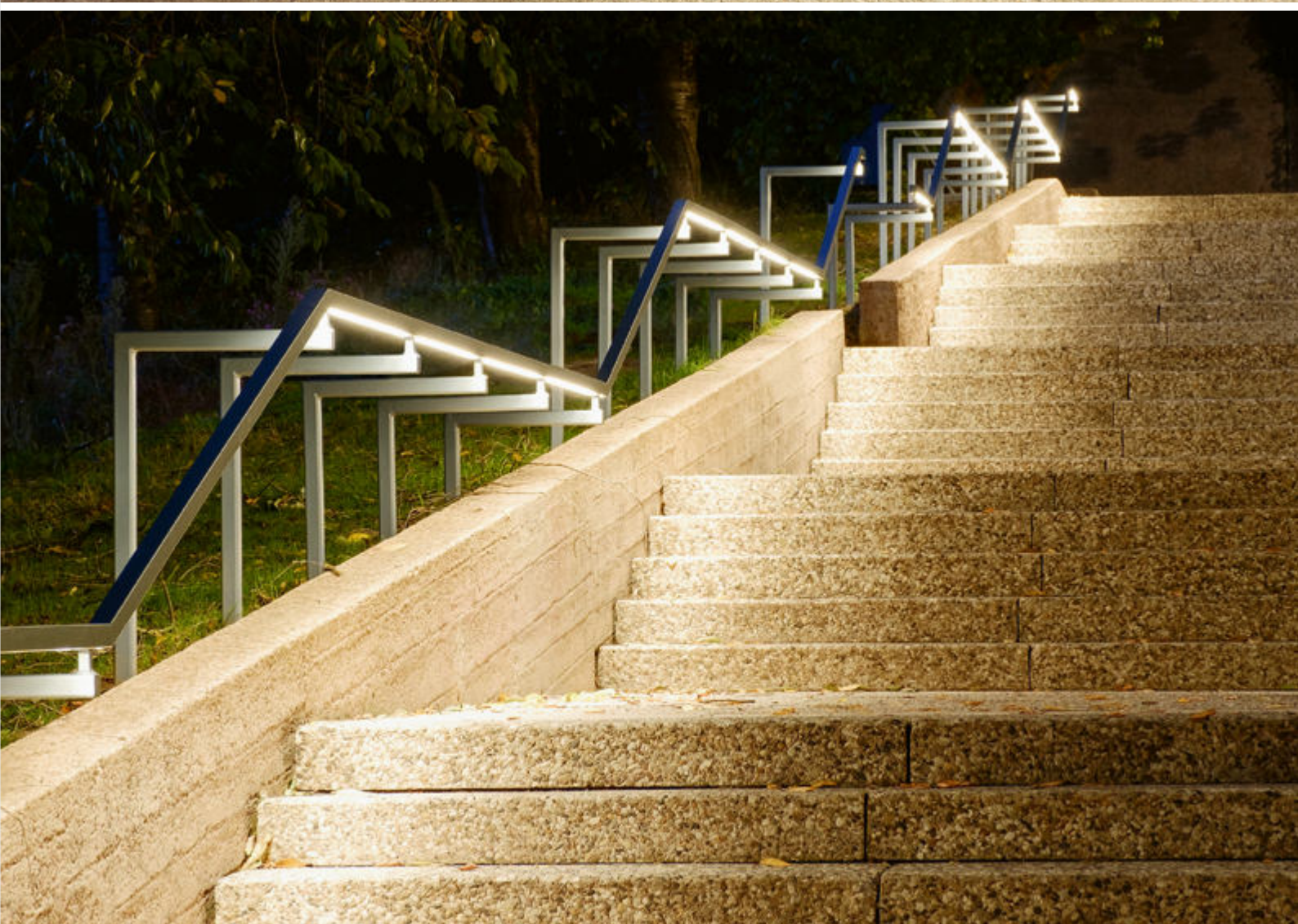

NP R1

Ein Blickfang an jeder Decke - bündig eingebaute Lichtlinien

Perfekte Integration in Trockenbauwände und Hohlräume: Mit unserem **NauticProfil® R1** Einbauprofil mit Rahmen bleiben Lichtlinien für funktionale Beleuchtungen und Design-effekte bis auf den Lichtaustritt verdeckt. Montiert wird das Profil mit Hilfe von Klammern oder Haltefedern, alternativ kann es auch einfach verschraubt werden.

An eye-catcher on any ceiling - flush-mounted light lines

Perfect integration into drywall and cavity ceilings: With our **NauticProfil® R1** installation profile with frame, light lines for functional lighting and design effects remain concealed except for the light emission. The profile is attached with the help of brackets or retaining springs, alternatively it can simply be screwed into place.

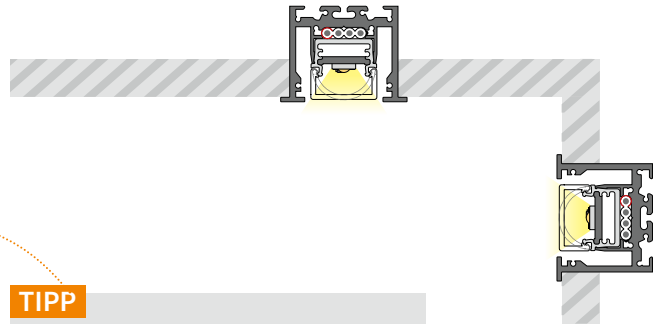
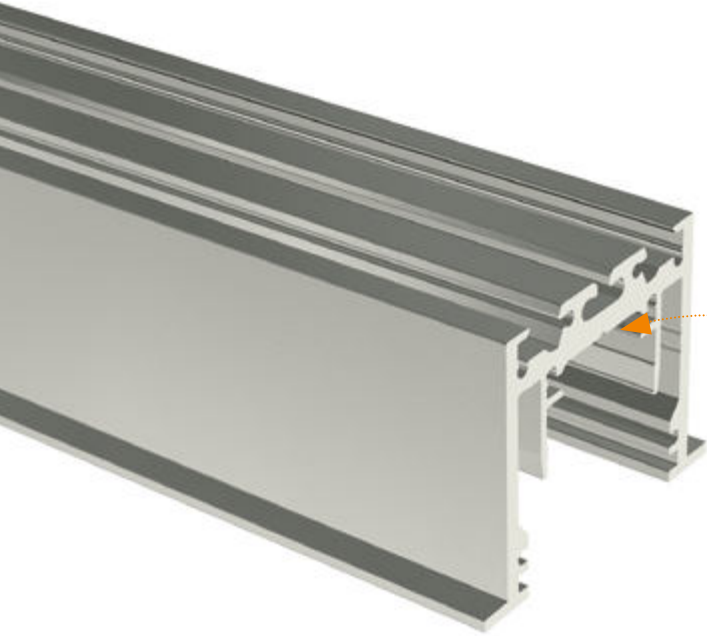



TIPP

Im Profilboden sind Montagelöcher aller 150 mm. Die Zentrierlinie im Boden des Profils ermöglicht das Bohren zusätzlicher Löcher ohne Verrutschen.

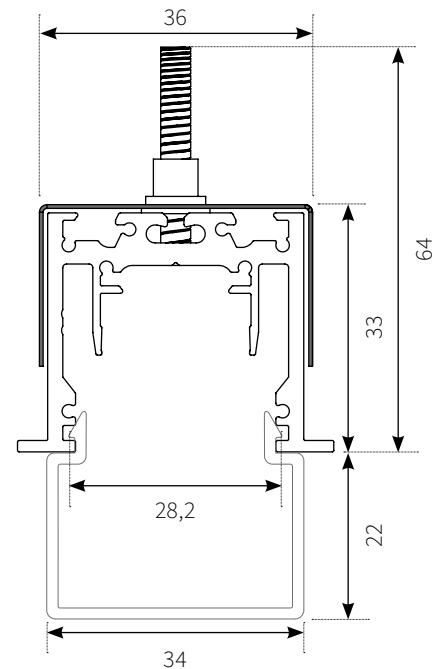
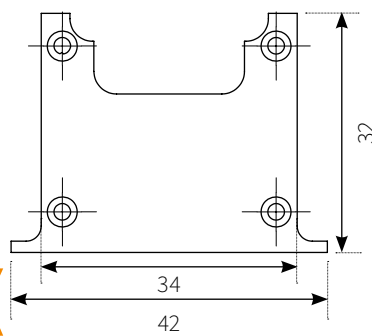
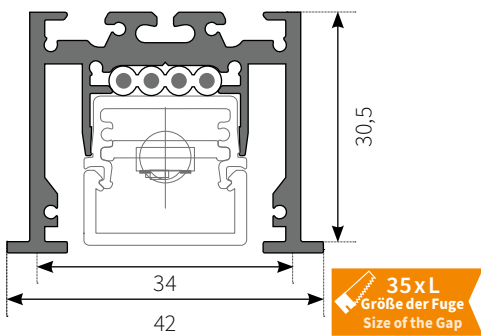
The bottom of the profile has holes every 150 mm. The auxiliary line in the profile allows drilled additional holes without grain.



-  .../ALA
alu anodized (standard)
E6EV1
-  .../BA
black anodized
E6C14
-  .../TWP
RAL9016 traffic white
fine structure (powdered)

Sonderfarben auf Anfrage! Special colours on request!

Bitte bei NP Profil- und Endplatten-Bestellung die Art.Nr. um die gewünschte Farbe ergänzen. Bei gewünschtem Gehrungsschnitt die Art.Nr. um die Gradzahl, bei Bestellung des NP Flachkabels die Art.Nr. um die entsprechende Länge (mm) ergänzen. Bitte beachten Sie unser Formular für NauticProfil® Eck-Konfigurationen im Katalog und unter www.flashaar.de

Maßstab 1:1 / Alle Maßangaben in mm.
scale 1:1 / All dimensions in mm.

Please state the required colour with the article number when ordering NP profiles and end plates. Please state the required angle with the article number when ordering bevel cuts and state the corresponding length (mm) with the article number when ordering NP flat cables. Please take note of our form for NauticProfil® corner-connections and also at www.flashaar.de



© Bürgerhaus Herborn-Burg / FLASHAAR Ingenieure GmbH

Bestellnummer
item number

NP/R1-MP / 2010 / ###

Montagehinweis R-Bracket
installation note R-bracket

Befestigung
fasteners

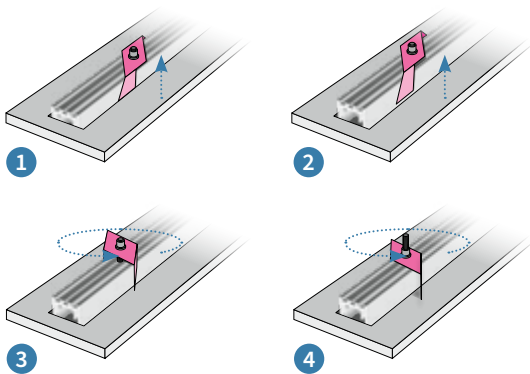

FLNP/R-BRACKET

Halterung für NP-R1 Montageprofil
bracket for NP-R mounting profile
(empfohlen / recommended)

FLNP/R-SPRING

Haltefeder für NP-R1 Montageprofil
retaining spring for NP-R1 mounting
profile

Artikel, Zubehör und Optionen
articles, accessories and options



NP/R1-MP/2010/###
(0510 /1010 /2010 oder 3020 x 42 x 32 mm)
NP-R1 Aluminium Montageprofil (indirekt)
NP-R1 aluminium mounting profile (indirect)

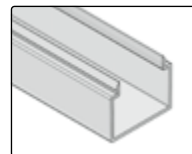

FL/CSH/2010
(34 x 28,2 x 1,5 mm)
Cover eckig hoch
cover square high



FLNP/R1-EP/2/###
(2 x 34 x 32 mm) mit Kabelausschuss /with cable release
Aluminium Endplatte für NP-R1 Montageprofil
aluminium end plate for NP-R1 mounting profile

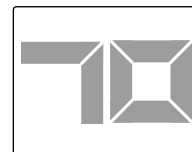

FL/B-CUT

Gehrungsschnitt für L-, U- oder Q-Konfiguration
bevel cut for L-, U- or Q-configuration



FLNP/R1-EP/2/D/###
(2 x 34 x 32 mm) mit Kabelausschuss /with cable release
Aluminium Endplatte mit Steg für NP-R1 Montageprofil
aluminium end plate with bar for NP-R1 mounting
profile



FLNP/FCable-UV

(4x2,5/3,45 mm² /0,122 kg/m)
NP Flachkabel 4 x 2,5 mm², UV-beständig
NP flat cable 4 x 2,5 mm², UV resistant

NP R2

Rahmenlose Integration von dezenter Lichtlinien

Das **NauticProfil® R2** eignet sich sowohl für den Anbau an Wand und Decke, als auch zur rahmenlosen Integration in Hohlraumdecken oder Trockenbauwände. Als Einbauprofil lässt es sich optimal in Hohlräume, wie zum Beispiel in Handläufe, integrieren. Mit unserem NauticProfil® R2 bleiben Lichtlinien für funktionale Beleuchtungen und Designeffekte bis auf den Lichtaustritt verdeckt. Eine zusätzliche Abdeckung kann in den oberen Teil des Profils werkzeuglos eingeklickt werden.



TIPP

Im Profildboden sind Montagelöcher aller 150 mm. Die Zentrierlinie im Boden des Profils ermöglicht das Bohren zusätzlicher Löcher ohne Ver-rutschen.

The bottom of the profile has holes every 150 mm. The auxiliary line in the profile allows drilled additional holes without grain.

 .../ALA
alu anodized (standard)
E6EV1

 .../BA
black anodized
E6C14

 .../TWP
RAL9016 traffic white
fine structure (powdered)

Sonderfarben auf Anfrage! Special colours on request!

Bitte bei NP Profil- und Endplatten-Bestellung die Art.Nr. um die gewünschte Farbe ergänzen. Bei gewünschtem Gehrungsschnitt die Art.Nr. um die Gradzahl, bei Bestellung des NP Flachkabels die Art.Nr. um die entsprechende Länge (mm) ergänzen. Bitte beachten Sie unser Formular für NauticProfil® Eck-Konfigurationen im Katalog und unter www.flashaar.de

Frameless integration of discreet light lines

The **NauticProfil® R2** profile is suitable for mounting on walls and ceilings as well as for frameless integration into cavity ceilings or drywalls. As a mounting profile, it can be optimally integrated into cavities, like handrails for example.

With our NauticProfil® R2, light lines for functional lighting and design effects remain hidden except for the light emission. An additional cover can be clicked into the upper part of the profile without tools.

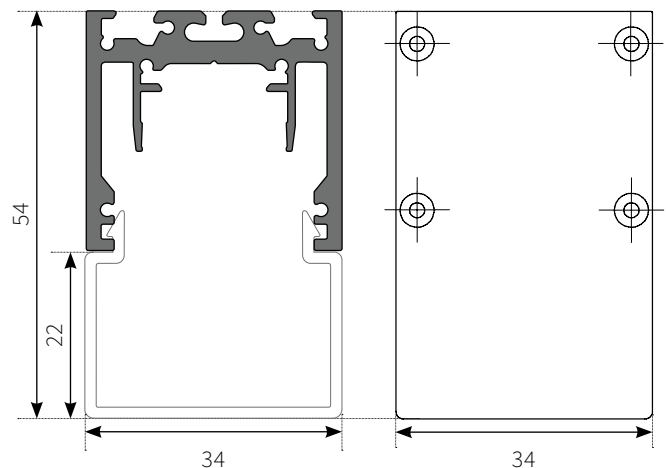
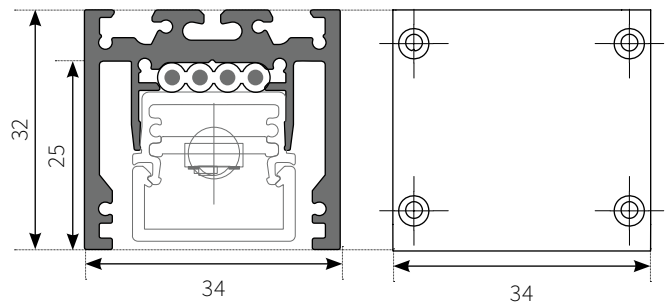
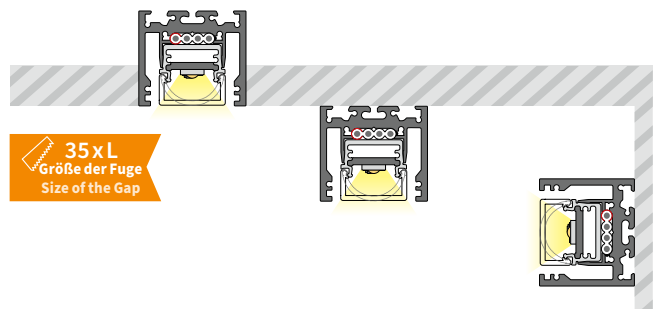

Maßstab 1:1 / Alle Maßangaben in mm.
scale 1:1 / All dimensions in mm.

Please state the required colour with the article number when ordering NP profiles and end plates. Please state the required angle with the article number when ordering bevel cuts and state the corresponding length (mm) with the article number when ordering NP flat cables. Please take note of our form for NauticProfil® corner-connections and also at www.flashaar.de



© MSZ Cuxhaven / Verwaltungsleitungsleitung des MSZ

Bestellnummer
item number

NP/R2-MP / 2010 / ###

Montagehinweis
installation note

Das Profil wird direkt verschraubt. Zur Befestigung befinden sich im Abstand vom 150mm Montagelöcher im Profilboden. Durch die Hilfslinie im Boden können zusätzliche Löcher ohne Körnung ins Profil gebohrt werden.

The profile is bolted directly. Mounting holes are provided at the bottom of the profile at 150 mm intervals. The auxiliary line in the profile allows drilled additional holes without grain.

Artikel, Zubehör und Optionen
articles, accessories and options



NP/R2-MP/2010/###
(0510 /1010 /2010 oder 3020 x 34 x 32 mm)
NP-R2 Aluminium Montageprofil
NP-R2 aluminium mounting profile

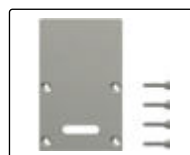

FLNP/R2-EP/2/CSH/###
(2 x 34 x 54 mm) mit Kabelauslass/
with cable release
Aluminium Endplatte hoch für NP-R2 Montageprofil
aluminium end plate high for NP-R2 mounting profile

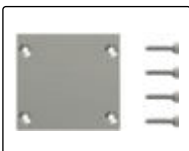

FLNP/R2-EP/###
(2 x 34 x 32 mm) ohne Kabelauslass/
without cable release
Aluminium Endplatte für NP-R2 Montageprofil
aluminium end plate for NP-R2 mounting profile

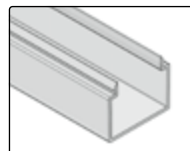

FL/CSH/2010
(34 x 28,2 x 1,5 mm)
Cover eckig hoch
cover square high

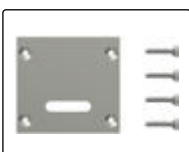

FLNP/R2-EP/2/###
(2 x 34 x 32 mm) mit Kabelauslass/
with cable release
Aluminium Endplatte für NP-R2 Montageprofil
aluminium end plate for NP-R2 mounting profile



FL/B-CUT
Gehrungsschnitt für L-, U- oder Q-Konfiguration
bevel cut for L-, U- or Q-configuration



FLNP/R2-EP/CSH/###
(2 x 34 x 54 mm) ohne Kabelauslass/
without cable release
Aluminium Endplatte hoch für NP-R2 Montageprofil
aluminium end plate high for NP-R2 mounting profile



FLNP/FCable-UV
(4x2,5/3,45 mm²/0,122 kg/m)
NP Flachkabel 4 x 2,5mm², UV-beständig
NP flat cable 4 x 2,5mm², UV resistant

NP R3

Ideal für den Einbau in Gipskarton-Wände oder Decken

Das **NauticProfil® R3** ist ein massives, rahmenloses Deckeneinbauprofil, welches bündig in der Wand/Rigips-Decke integriert werden kann und somit ein Teil derselben wird. Es kann einfach oder, bei höheren Lasten, doppelt beplankt werden. Die großen Flächen sorgen für Stabilität und ermöglichen zusätzlich eine hervorragende Wärmeableitung, wodurch Rissbildungen entlang der Stoßstellen vermieden werden. Konverter sind auch im eingebauten Zustand einfach und sauber durch das R3 Profil integrierbar.

Ideal for installation in plasterboard walls or ceilings

The **NauticProfil® R3** is a solid, frameless recessed ceiling profile which can be integrated flush into the wall/Rigips ceiling and thus becomes a part of it. It can have single or, for higher loads, double planking. The large surfaces provide stability as well as excellent heat dissipation, preventing cracking along the joints. Converters can be easily and cleanly integrated through the profile even when already installed. Discreet, long and frameless light lines assimilate perfectly into any architectural design thanks to the R3 profile.

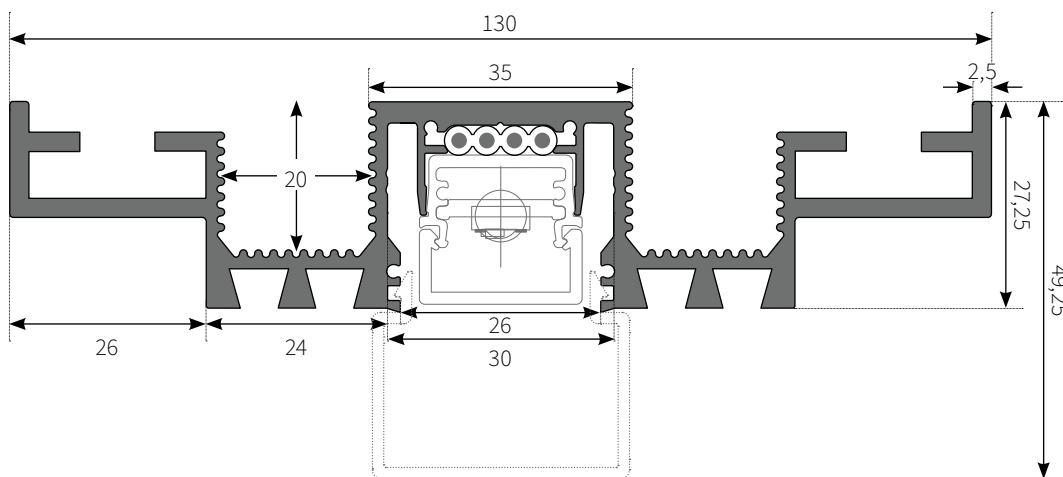
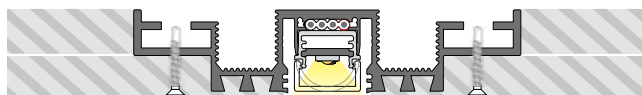
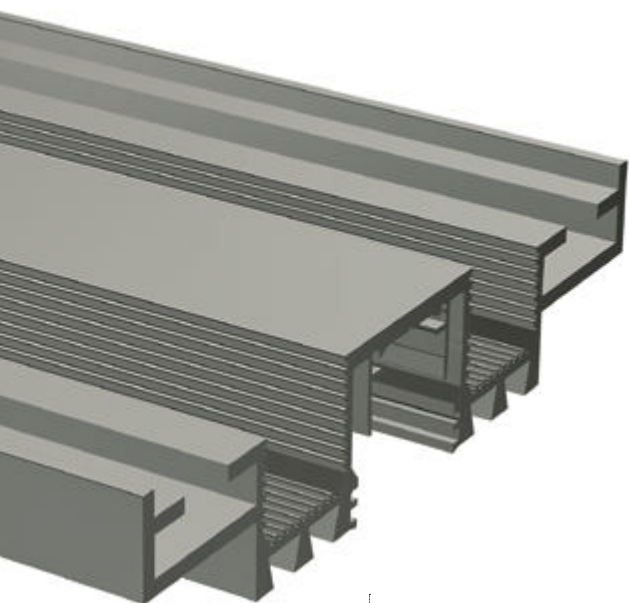

.../ALA
alu anodized (standard)
E6EV1



.../BA
black anodized
E6C14



.../TWP
RAL9016 traffic white
fine structure (powdered)

Sonderfarben auf Anfrage! Special colours on request!

Bitte bei NP Profil- und Endplatten-Bestellung die Art.Nr. um die gewünschte Farbe ergänzen. Bei gewünschtem Gehrungsschnitt die Art.Nr. um die Gradzahl, bei Bestellung des NP Flachkabels die Art.Nr. um die entsprechende Länge (mm) ergänzen. Bitte beachten Sie unser Formular für NauticProfil® Eck-Konfigurationen im Katalog und unter www.flashaar.de

Maßstab 1:1 / Alle Maßangaben in mm.
scale 1:1 / All dimensions in mm.

Please state the required colour with the article number when ordering NP profiles and end plates. Please state the required angle with the article number when ordering bevel cuts and state the corresponding length (mm) with the article number when ordering NP flat cables. Please take note of our form for NauticProfil® corner-connections and also at www.flashaar.de



© WTZ-Tagungszentrum, Heilbronn / FLASHAAR Ingenieure GmbH

Bestellnummer
item number

NP/R3-MP / 2010 / ###

Montagehinweis
installation note

Das **NauticProfil® R3** wird bündig in der Wand/Rigipsdecke verschraubt und anschließend verspachtelt. Es kann einfach oder doppelt beplankt werden.

The **NauticProfil® R3** is mounted flush into the wall/plaster ceiling and then filled. It can be planked easily or twice.

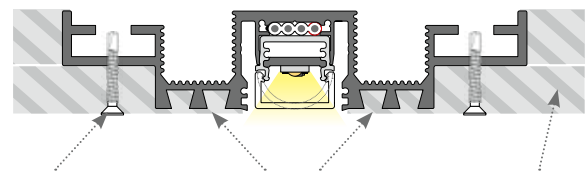

Verschraubung
screw connection

Verspachtelung
filling

Rigipsdecke
plaster ceiling

Artikel, Zubehör und Optionen
articles, accessories and options



NP/R3-MP/2010/###
(0510 /1010 /2010 oder 3020 x 130 x 27,25 mm)
NP-R3 Aluminium Montageprofil (indirekt)
NP-R3 aluminium mounting profile (indirect)



SNP60-24-24VFP-1
(LxBxH: 297x30x18 mm)
Konverter CV 24V DC, IP66, Betriebstemp.: -20°...+45°C
converter CV 24V DC, IP6, operation temp.: -20°...+45°C

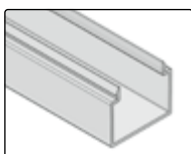

FL/CSH/2010
(34 x 28,2 x 1,5 mm)
Cover eckig hoch
cover square high

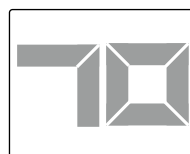

FL/B-CUT
Gehrungsschnitt für L-, U- oder Q-Konfiguration
bevel cut for L-, U- or Q-configuration

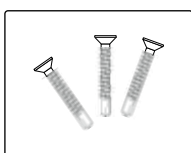

Bohrschrauben (nicht inkl.)
Wir empfehlen handelsübliche Bohrschrauben.
We recommend commercially available self-drilling screws.



FLNP/FCable-UV
(4x2,5/3,45 mm² / 0,122 kg/m)
NP Flachkabel 4 x 2,5 mm², UV-beständig
NP flat cable 4 x 2,5 mm², UV resistant

NP R4

Einzigartiges Einbauprofil, zur Integration in Fassaden-Dämmplatten

Ein LED Profil, das sich einfach in eine verputzte Wärme-dämmverbundsystem (WDVS) Fassade integrieren lässt? Kein Problem.

In Zusammenarbeit mit einem WDV-Systemhersteller haben wir das **NauticProfil® R4** genau für diesen Zweck entwickelt. Dieses spezielle Einbauprofil wird in die Fassaden-Dämmplatte eingelassen und mittels PU-Kleber verklebt.

Im Anschluss wird das seitliche Armierungsgewebe am R4-Profil, mit dem systemzugehörigen Armierungsmörtel eingespachtelt und an den Flanken flächenbündig angeputzt.

Unique installation profile, for integration in facade insulation panels

An LED profile that can be easily integrated into a plastered external thermal insulation system? No problem.

In cooperation with a manufacturer, we have developed the **NauticProfil® R4** precisely for this purpose. This special installation profile can be embedded in the facade insulation board and glued with PU adhesive.

Then the side mesh of the R4 profile is filled with the reinforcement mortar that belongs to the system and plastered flush on the flanks of the profile.

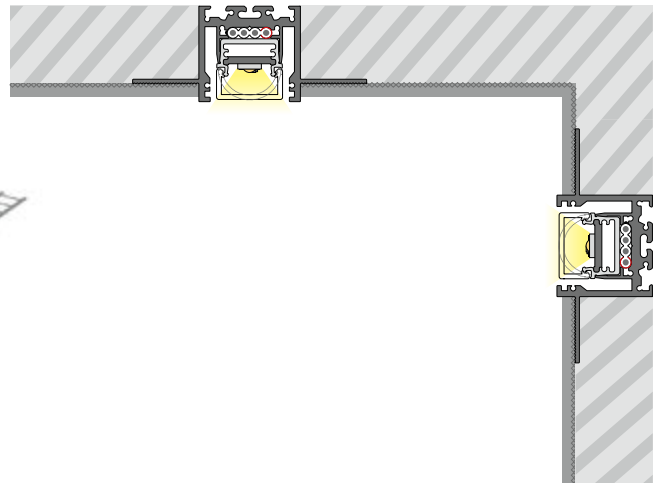
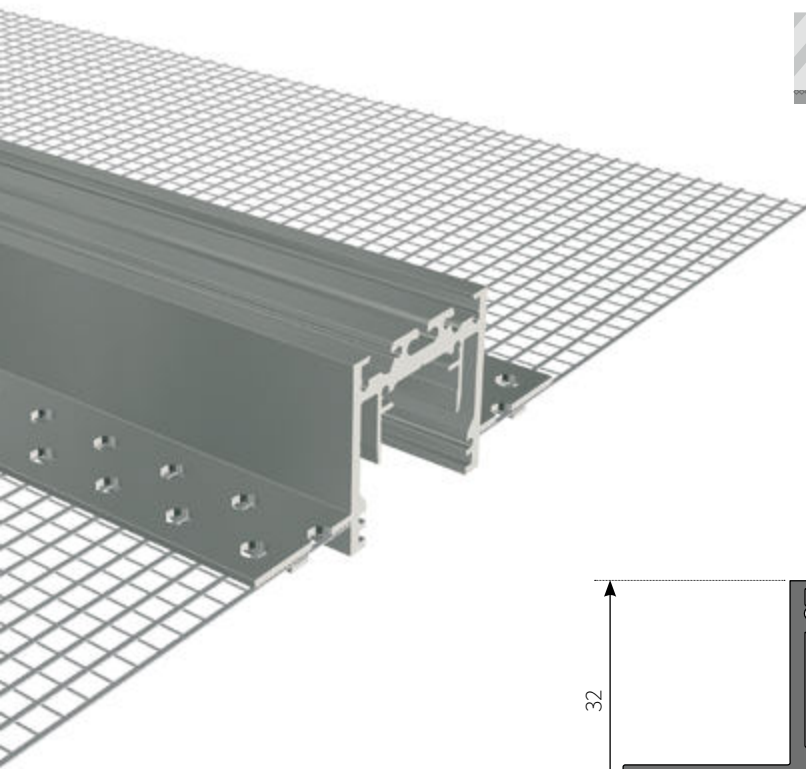

35 x L
Größe der Fuge
Size of the Gap

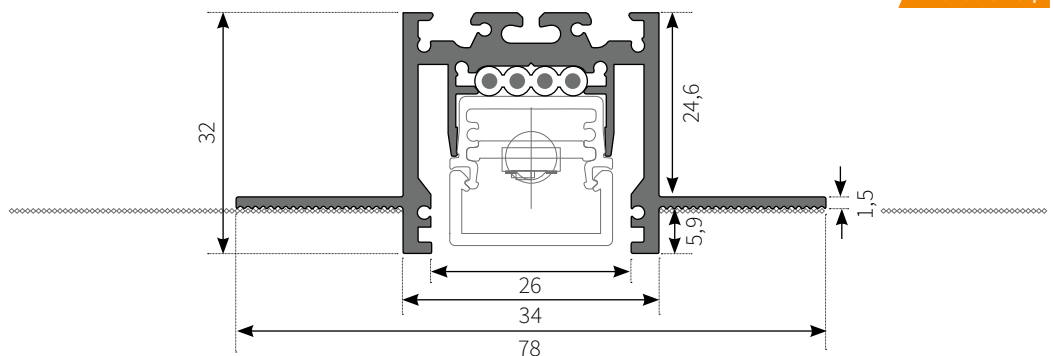

.../ALA
alu anodized (standard)
E6EV1

.../BA
black anodized
E6C14

.../TWP
RAL 9016 traffic white
fine structure (powdered)

Sonderfarben auf Anfrage! Special colours on request!

Bitte bei NP Profil- und Endplatten-Bestellung die Art.Nr. um die gewünschte Farbe ergänzen. Bei gewünschtem Gehrungsschnitt die Art.Nr. um die Gradzahl, bei Bestellung des NP Flachkabels die Art.Nr. um die entsprechende Länge (mm) ergänzen. Bitte beachten Sie unser Formular für NauticProfil® Eck-Konfigurationen im Katalog und unter www.flashaar.de

Maßstab 1:1 / Alle Maßangaben in mm.
scale 1:1 / All dimensions in mm.

Please state the required colour with the article number when ordering NP profiles and end plates. Please state the required angle with the article number when ordering bevel cuts and state the corresponding length (mm) with the article number when ordering NP flat cables. Please take note of our form for NauticProfil® corner-connections and also at www.flashaar.de



© Sparkasse Rhein-Nahe, Bad Kreuznach / Alexander Sell

Bestellnummer
item number

NP/R4-MP / 2010 / ###

Montagehinweis
installation note

Durch Ausfräsungen im Profil – bitte bei Bestellung angeben – können entsprechend schmale Konverter (<25 mm) und Installationen auch im eingebauten Zustand durch das Profil in entsprechenden Hohlräumen von Decke oder Wand verstaut werden. Die Ausfräsungen werden später durch die Lichteinsätze abgedeckt.

By means of cut-outs in the profile - please specify when ordering - correspondingly narrow converters (<25 mm) and installations can be stowed through the profile in corresponding cavities of the ceiling or wall even when installed. The cut-outs are later covered by the light inserts.



Artikel, Zubehör und Optionen
articles, accessories and options



NP/R4-MP/2010/###
(0510 /1010 /2010 oder 3020 x 78 x 32 mm)
NP-R4 Aluminium Montageprofil (indirekt)
NP-R4 aluminium mounting profile (indirect)

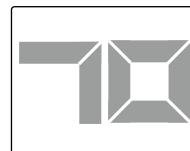

FL/B-CUT

Gehrungsschnitt für L-, U- oder Q-Konfiguration
bevel cut for L-, U- or Q-configuration



FLNP/FCable-UV

(4x2,5/3,45 mm²/0,122 kg/m)
NP Flachkabel 4 x 2,5 mm², UV-beständig
NP flat cable 4 x 2,5 mm², UV resistant

Beispielhafte Montage example of assembly

Das Armierungsgewebe ist werkseitig an beiden Seiten des Nautic-Profil® R4 befestigt.

Das NauticProfil® R4 wird in die vorbereitete Nut in den verlegten Fassadendämmplatten eingelassen und verklebt.

Der PU-Kleber muss großzügig an den Profilstößen aufgetragen werden, damit diese wasserdicht versiegelt werden und kein Wasser in das Dämmsystem eintritt.

Anschließend wird das seitliche Gewebe am R4-Profil mittels systemzugehörigen Armierungsmörtel eingespachtelt. Nach Trocknung, in der Regel am nächsten Tag, wird das Armierungsgewebe über die gesamte Fassadenfläche gespachtelt. So entsteht an jedem Profil eine Überlappung des Gewebes und damit die notwendige Riss-Sicherheit. Nach Trocknung der Armierungsschicht kann der Fassadenputz aufgetragen werden.

The reinforcement mesh is attached to both sides of the Nautic-Profil® R4 at the factory.

The NauticProfil® R4 is embedded and glued into the prepared groove of the installed facade insulation panels.
The PU adhesive must be applied generously to the profile joints so that they are waterproof and no water can get into the insulation system.

The side mesh of the R4 profile is then filled with the reinforcement mortar that belongs to the system.

After drying, usually the next day, the reinforcement mesh is filled over the entire facade surface. This creates an overlap of the mesh on each profile and thus the necessary security against tears. After the reinforcement layer has dried, the facade plaster can be applied.

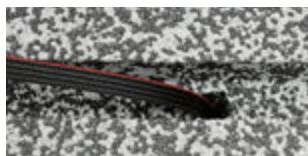
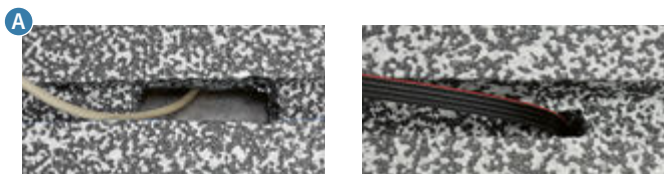
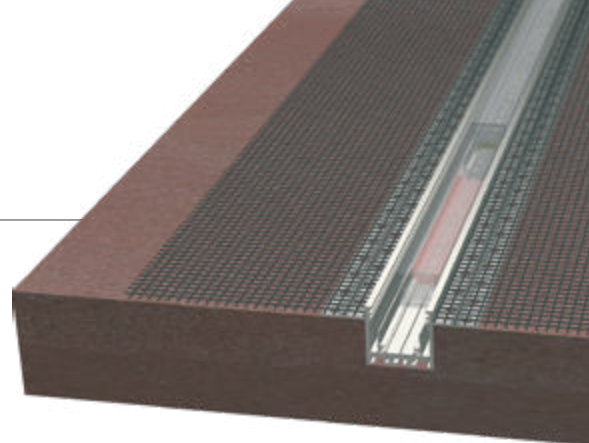

A) Anschlussleitung legen, Ausschnitt in der Dämmplatte je nach Kabelanschluss anpassen.

Lay the connection cable, adjust the cut-out in the insulation board according to the cable connection.

B) PU-Fassadenkleber (Schaum) auf Unterseite R4-Profil aufbringen und in den vorbereiteten Fassadenkanal eindrücken und ausrichten.

Apply the PU facade adhesive (foam) to the underside of the R4 profile and press it into the prepared facade channel and align.

C) Das seitliche Gewebe am R4-Profil einspachteln. Nach Trocknung der Armierungsschicht kann der Fassadenputz aufgetragen werden.

Fill in the side mesh of the r4 profile. After the reinforcement layer has dried, the facade plaster can be applied.

D) Anschluss des NP Flachkabels vornehmen und in den Hohlraum drücken.

Connect the NP flat cable and press it into the cavity.

E) Den Ausbruch für Stecker mit Brandschutzmasse versiegeln. (Versiegelung muss absolut wasserdicht ausgeführt werden!)

Danach das NP Flachkabel in das R4-Profil eindrücken.

Seal the cut-out for the plug with fire protection compound. (Sealing must be absolutely watertight!) Then press the NP flat cable into the R4 profile.

F) Nach dem Abtrocknen NP Leuchteinsätze montieren.

Die Montage ist fertig, das Anschlusskabel kann jetzt bauseitig an ein passendes VG angeschlossen und bestromt werden.

After drying, mount the NP light inserts.

The assembly is finished, the connection cable can now be connected to a suitable VG on site and supplied with current.



NP I1

Einbauleuchte zur Erzeugung von homogenen Lichtvouten

Indirekte und homogene Wand-, Decken-, Boden- und Stufenleuchten lassen sich mit dem **NauticProfil® I1** unkompliziert realisieren. Das vielseitige Einbauprofil verfügt über einen integrierten Reflektor.

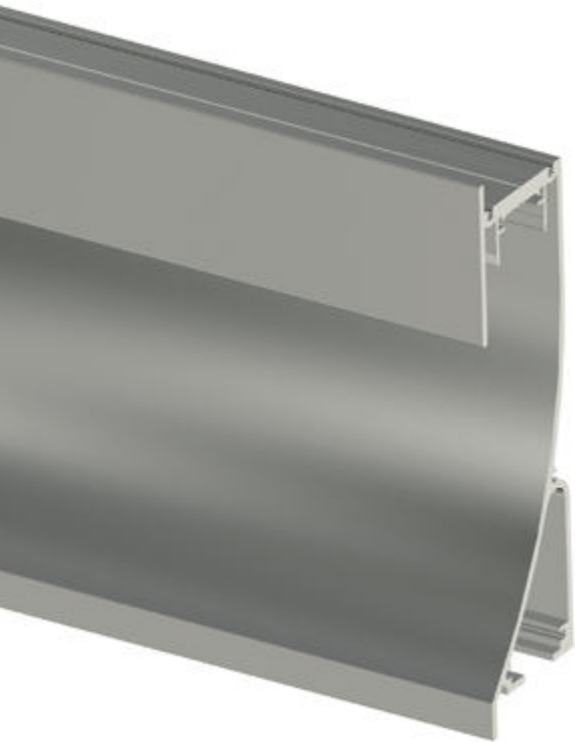

Zur Montage wird es einfach direkt in Trockenbauwänden und Hohlraumdecken verklebt.

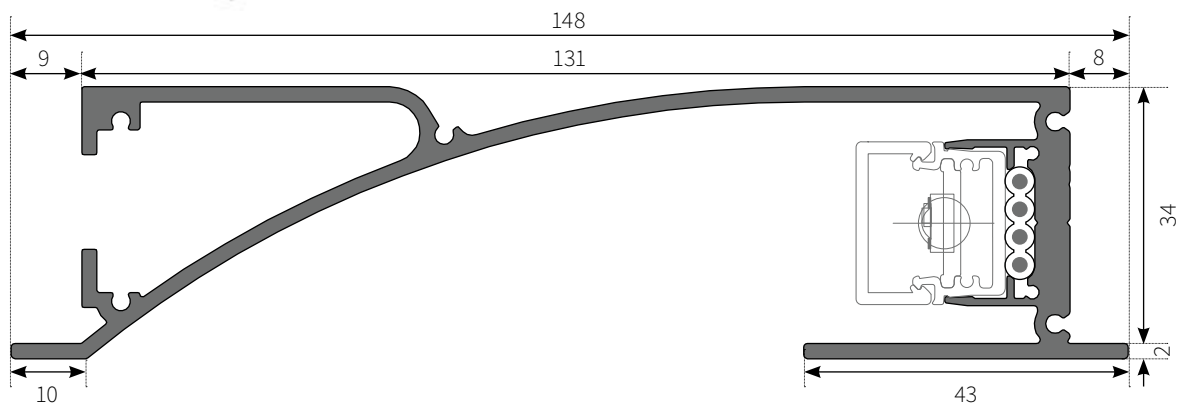
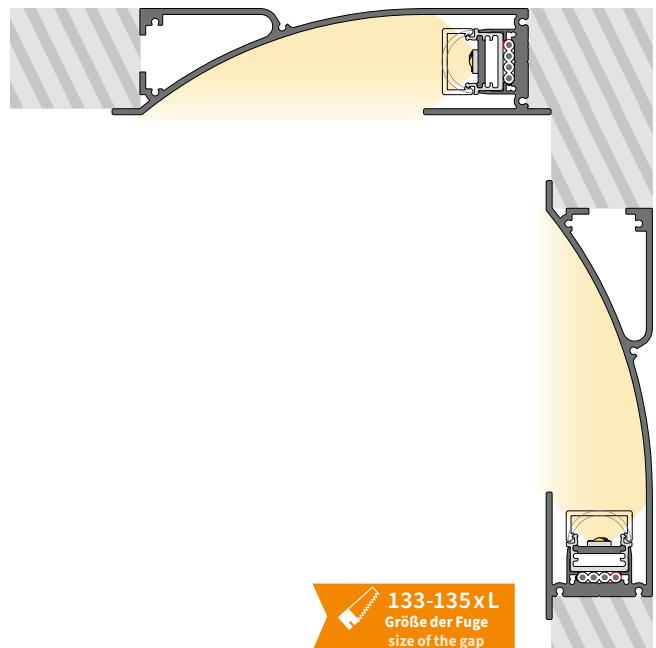

Flush-mounted luminaire for creating homogeneous coves of light

Indirect and homogeneous wall, ceiling, floor and step lighting may be easily realised with **NauticProfil® I1**. The versatile recessed profile possesses an integrated reflector. It is simply glued and fitted into drywalls and suspended ceilings.



-  .../ALA
alu anodized (standard)
E6EV1
-  .../BA
black anodized
E6C14
-  .../TWP
RAL 9016 traffic white
fine structure (powdered)

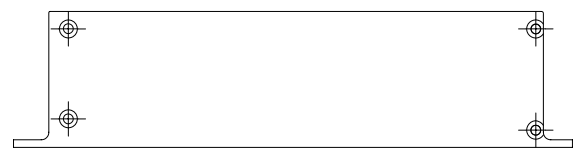

Endplatte NP I1; Maßstab 1:2
end plate NP I1; scale 1:2

Sonderfarben auf Anfrage! Special colours on request!

Bitte bei NP Profil- und Endplatten-Bestellung die Art.Nr. um die gewünschte Farbe ergänzen. Bei gewünschtem Gehrungsschnitt die Art.Nr. um die Gradzahl, bei Bestellung des NP Flachkabels die Art.Nr. um die entsprechende Länge (mm) ergänzen. Bitte beachten Sie unser Formular für NauticProfil® Eck-Konfigurationen im Katalog und unter www.flashaar.de

Maßstab 1:1 / Alle Maßangaben in mm.
scale 1:1 / All dimensions in mm.

Please state the required colour with the article number when ordering NP profiles and end plates. Please state the required angle with the article number when ordering bevel cuts and state the corresponding length (mm) with the article number when ordering NP flat cables. Please take note of our form for NauticProfil® corner-connections and also at www.flashaar.de



© Gründervilla Boehringer Ingelheim

Bestellnummer
item number

NP/I1-MP / 2010 / ###

Montagehinweis
installation note

Zur Montage wird es einfach direkt in Trockenbauwänden und Hohlraumdecken verklebt.

It is simply glued and fitted into drywalls and suspended ceilings.

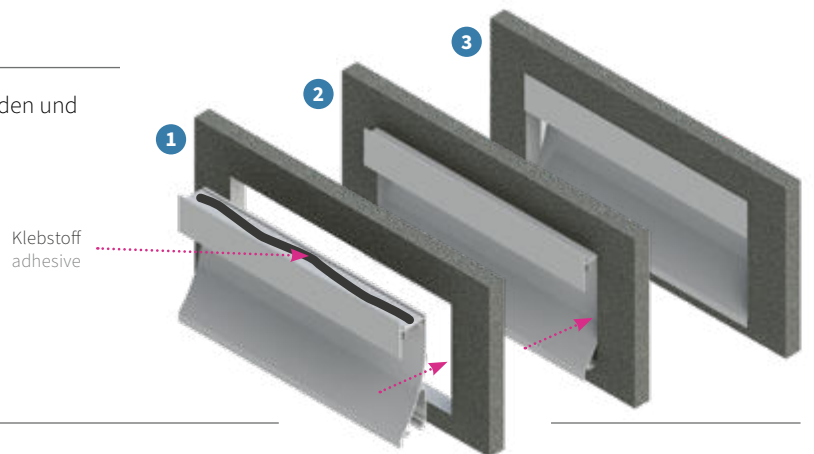

Artikel, Zubehör und Optionen
articles, accessories and options



NP/I1-MP/2010/###
(0510 /1010 /2010 oder 3020 x 36 x 148 mm)
NP-I1 Aluminium Montageprofil
NP-I1 aluminium mounting profile



FLNP/I1-EP/R/2/###
(2 x 36 x 148 mm) mit Kabelauslass/with cable release
Aluminium Endplatte für NP-I1 Montageprofil (rechts)
aluminium end plate for NP-I1 mounting profile (right)



FLNP/I1-EP/D/R/2/###
(2 x 36 x 148 mm) mit Kabelauslass/with cable release
Aluminium Endplatte für NP-I1 Montageprofil(rechts)
aluminium end plate for NP-I1 mounting profile (right)



FLNP/I1-EP/L/2/###
(2 x 36 x 148 mm) mit Kabelauslass/with cable release
Aluminium Endplatte für NP-I1 Montageprofil (links)
aluminium end plate for NP-I1 mounting profile (left)



FLNP/I1-EP/D/L/2/###
(2 x 36 x 148 mm) mit Kabelauslass/with cable release
Aluminium Endplatte für NP-I1 Montageprofil (links)
aluminium end plate for NP-I1 mounting profile (left)

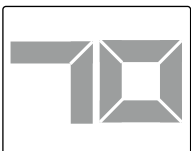

FL/B-CUT
Gehrungsschnitt für L-, U- oder Q-Konfiguration
bevel cut for L-, U- or Q-configuration



FLNP/FCable-UV
(4x2,5/3,45 mm²/0,122 kg/m)
NP Flachkabel 4 x 2,5mm², UV-beständig
NP flat cable 4 x 2,5mm², UV resistant

NP I2

Anbauleuchte zur Erzeugung einer Lichtvoute

Basierend auf dem NauticProfil® I1 wurde das **NauticProfil® I2** für die An- und Aufbaumontage entwickelt. Die Leuchten können auch auf Möbeln (z. B. Schränken) platziert werden und sorgen so für eine indirekte Beleuchtung der Decke.
Am Übergang zwischen der Fläche des Reflektors und der Gehäusefront ist eine Kante mit eingepresst. Dies ermöglicht eine scharfe Abrisskante zwischen hell und dunkel und sorgt für präzise Lichtzeichnungen.

Mounted luminaire for creating coved lighting

Based on the NauticProfil® I1, the **NauticProfil® I2** was developed for surface and surface-mounted installation. The luminaires can also be placed on furniture (e.g. cabinets) and thus provide indirect ceiling lighting.
At the transition between the surface of the reflector and the front of the housing, an edge is pressed in. This allows for a sharp tear-off edge between light and dark and ensures precise light drawings.

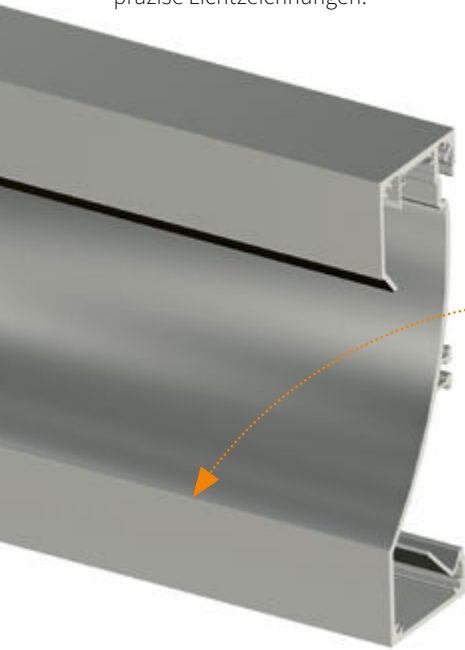

TIPP

Die Kante schafft einen scharfen Kontrast zwischen hell und dunkel.

The edge creates a sharp contrast between light and dark.

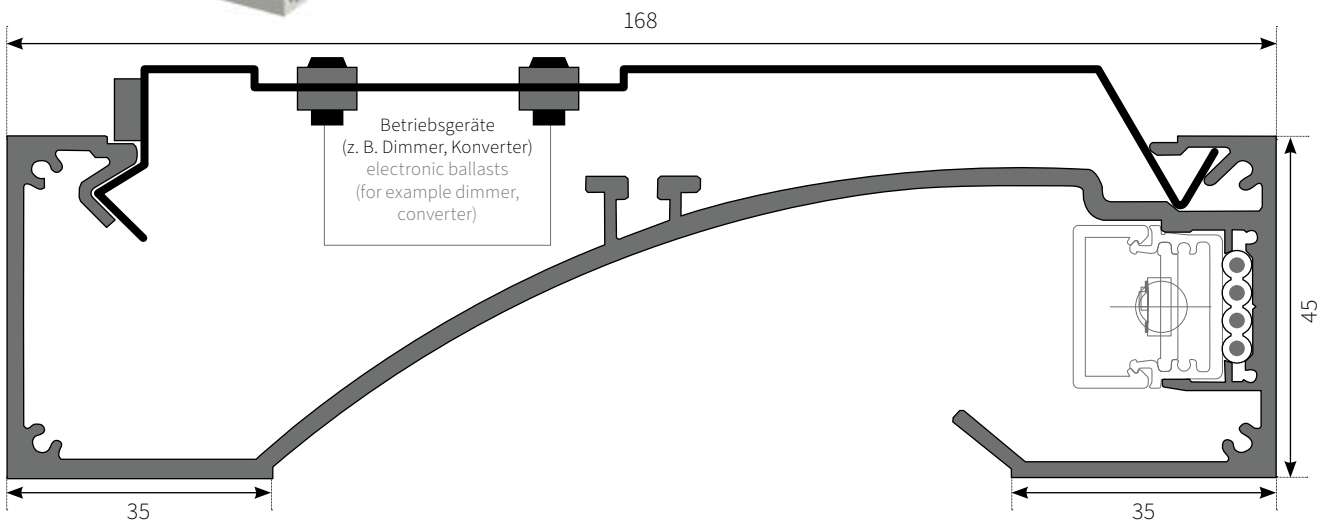
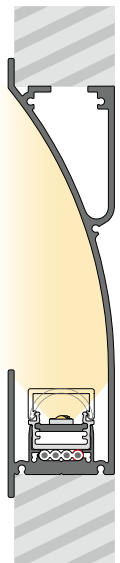

.../ALA
alu anodized (standard)
E6EV1

.../BA
black anodized
E6C14

.../TWP
RAL9016 traffic white
fine structure (powdered)

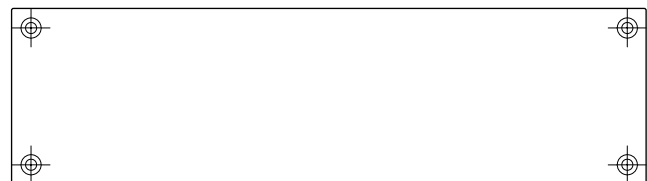

Endplatte NP I2; Maßstab 1:2
end plate NP I2; scale 1:2

Sonderfarben auf Anfrage! Special colours on request!

Bitte bei NP Profil- und Endplatten-Bestellung die Art.Nr. um die gewünschte Farbe ergänzen. Bei gewünschtem Gehrungsschnitt die Art.Nr. um die Gradzahl, bei Bestellung des NP Flachkabels die Art.Nr. um die entsprechende Länge (mm) ergänzen. Bitte beachten Sie unser Formular für NauticProfil® Eck-Konfigurationen im Katalog und unter www.flashaar.de

Maßstab 1:1 / Alle Maßangaben in mm.
scale 1:1 / All dimensions in mm.

Please state the required colour with the article number when ordering NP profiles and end plates. Please state the required angle with the article number when ordering bevel cuts and state the corresponding length (mm) with the article number when ordering NP flat cables. Please take note of our form for NauticProfil® corner-connections and also at www.flashaar.de



© Ústí nad Orlicí - Bahnunterführung / Vladimír Gernát, ENIKA.CZ s. r. o.

Bestellnummer
item number

NP/I2-MP / 2010 / ###

Befestigung
fasteners

NP/I2-M-plate

Haltebügel für NP-I2 Montageprofil. Auf Wunsch fertig bestückt mit Konverter und Dimmer.

- 1 Montage Haltebügels inkl. Konverter und Dimmer an die Wand/Decke.
- 2 Die Leuchte einseitig in den Haltebügel einhängen.
- 3 Elektrischen Anschluss vornehmen. Danach die eingehängte Leuchte in den Haltebügel einrasten.

Mounting bracket for NP-I2 mounting profile. On request, ready-equipped with a converter and dimmer.

- 1 Mounting bracket incl. converter and dimmer on the wall/ceiling.
- 2 Hook the luminaire into the retaining bracket on one side.
- 3 Make the electrical connection. Then snap the suspended luminaire into the retaining bracket.

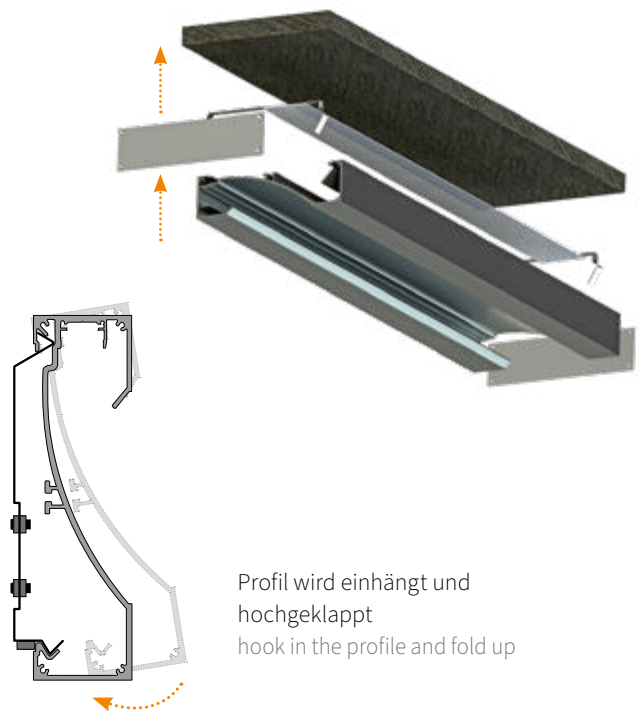

Profil wird eingehängt und hochgeklappt
hook in the profile and fold up

Artikel, Zubehör und Optionen
articles, accessories and options



NP/I2-MP/2010/###
(0510 /1010 /2010 oder 3020 x 45 x 168 mm)
NP-I2 Aluminium Montageprofil
NP-I2 aluminium mounting profile

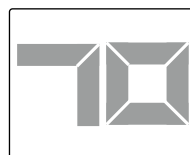

FL/B-CUT
Gehrungsschnitt für L-, U- oder Q-Konfiguration
bevel cut for L-, U- or Q-configuration

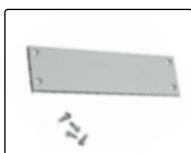

FLNP/I2-EP/###
(2 x 37,2 x 165 mm) ohne Kabelauslass/
without cable release
Aluminium Endplatte für NP-I2 Montageprofil
aluminium end plate for NP-I2 mounting profile



FLNP/FCable-UV
(4x2,5/3,45 mm²/0,122 kg/m)
NP Flachkabel 4 x 2,5mm², UV-beständig
NP flat cable 4 x 2,5mm², UV resistant



Beleuchtung der Unterführung des Bahnhofs in Ústí nad Orlicí

Im Jahr 2021 begann die Umgestaltung und Modernisierung der Unterführung des Bahnhofs in Ústí nad Orlicí - einer der ältesten in der Tschechischen Republik. Als geeignete Leuchte für die geforderte Beleuchtungsaufgabe, wurde eine Sonderleuchte basierend auf dem NauticProfil® I2 von FLASHAAR® ausgewählt. Bestückt mit der LED-Linie Navigator ergibt das indirekte Licht der NP I2 einen weichen und lichten Raum und zusammen mit den Wandbemalungen eine angenehme Atmosphäre.

Lighting of the subway of the railway station in Ústí nad Orlicí

In 2021, the redesign and modernisation of the railway station subway in Ústí nad Orlicí - one of the oldest in the Czech Republic - began. A special luminaire based on the NauticProfil® I2 from Flashaar® was selected as a suitable luminaire for the required lighting task. Equipped with the Navigator LED line, the indirect light of the NP I2 creates a soft and bright room and, together with the wall coverings, a pleasant atmosphere.



2. nástupiště ↑
1. nástupiště východ ←
3. nástupiště →

NP W1

Kleine Leuchte, große Wirkung - perfekte Alternative zu Trockenbauvouten

Lichtvouten einfach planen und realisieren: Das **NauticProfil® W1** wird mittels Montageplatten an der Wand oder mit Magnethaltern, z. B. an T-Trägern aus Eisen, befestigt. Betriebsgeräte verschwinden unter einer Abdeckung. Damit ist das NP W1 die perfekte Alternative zu Trockenbauvouten. Mit dieser stilvollen Wandleuchten lassen sich indirekte Beleuchtungen und stimmungsvolle Lichtinszenierungen einfach umsetzen.

Small luminaire, big effect - a perfect alternative to drywall coving

Easy to plan and realise coved lighting: The **NauticProfil® W1** is secured to walls using mounting plates or magnetic holders. Controllers disappear under covers. This makes the NP W1 the perfect alternative to coved lighting in drywalls. With this stylish wall luminaire, indirect lighting and atmospheric light settings can be easily realised.

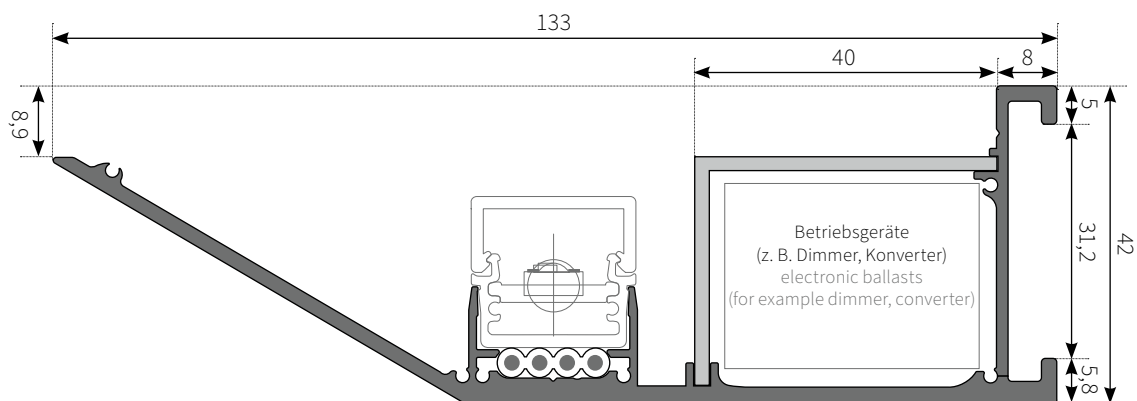
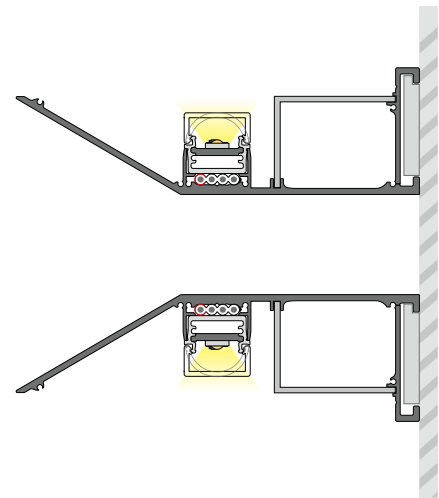
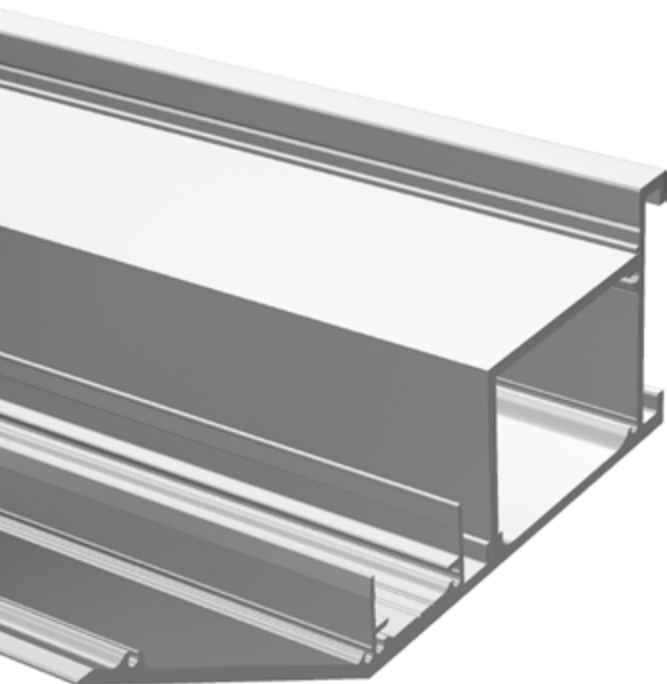

- .../ALA
alu anodized (standard)
E6EV1
- .../BA
black anodized
E6C14
- .../TWP
RAL9016 traffic white
fine structure (powdered)

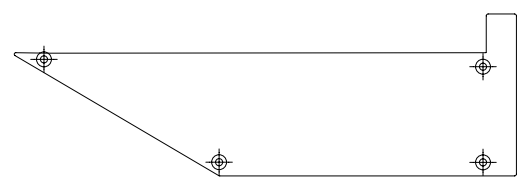

Endplatte NP W1; Maßstab 1:2
end plate NP W1; Scale 1:2

Sonderfarben auf Anfrage! Special colours on request!

Bitte bei NP Profil- und Endplatten-Bestellung die Art.Nr. um die gewünschte Farbe ergänzen. Bei gewünschtem Gehrungsschnitt die Art.Nr. um die Gradzahl, bei Bestellung des NP Flachkabels die Art.Nr. um die entsprechende Länge (mm) ergänzen. Bitte beachten Sie unser Formular für NauticProfil® Eck-Konfigurationen im Katalog und unter www.flashaar.de

Maßstab 1:1 / Alle Maßangaben in mm.
scale 1:1 / All dimensions in mm.

Please state the required colour with the article number when ordering NP profiles and end plates. Please state the required angle with the article number when ordering bevel cuts and state the corresponding length (mm) with the article number when ordering NP flat cables. Please take note of our form for NauticProfil® corner-connections and also at www.flashaar.de



© Trauerhalle Bühn, Mannheim / Bukma Licht + Leuchten GmbH

Bestellnummer
item number

NP/W1-MP / 2010 / ###

Befestigung
fasteners

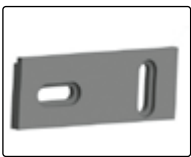

FLNP/W-PLATE/ALA
(90 x 31 x 5 mm)
Befestigungsplatte für NP-W Montageprofil
mounting plate for NP-W mounting profile



magnetische Befestigung auf Anfrage
magnetic mounting on request

Artikel, Zubehör und Optionen
articles, accessories and options

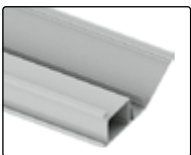

NP/W1-MP/2010/###
(0510 /1010 /2010 oder 3020 x 133 x 42 mm)
NP-W1 Aluminium Montageprofil (indirekt)
NP-W1 aluminium mounting profile (indirect)

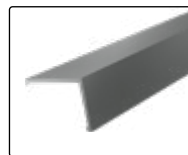

FLNP/W-L/2010/###
(30 x 40 x 2010 mm)
Aluminium Winkel (standardmäßig inklusive)
angle aluminium (included as standard)



FLNP/W1-EP/L/1/###
(2 x 133 x 42 mm)
Aluminium Endplatte für NP-W1 Montageprofil (links)
aluminium end plate for NP-W1 mounting profile (left)

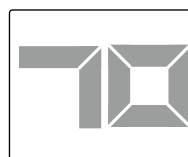

FL/B-CUT
Gehrungsschnitt für L-, U- oder Q-Konfiguration
bevel cut for L-, U- or Q-configuration



FLNP/W1-EP/R/1/###
(2 x 133 x 42 mm)
Aluminium Endplatte für NP-W1 Montageprofil (rechts)
aluminium end plate for NP-W1 mounting profile (right)



FLNP/FCable-UV
(4x2,5/3,45 mm²/0,122 kg/m)
NP Flachkabel 4 x 2,5 mm², UV-beständig
NP flat cable 4 x 2,5 mm², UV resistant

NP W2

Kleine Leuchte, große Wirkung - perfekte Alternative zu Trockenbauvouten

Das **NauticProfil® W2** ist eine elegante, flache Alternative zu Trockenbauvouten und wird mittels Montageplatten an der Wand oder mit Magnethaltern, z. B. an T-Trägern aus Eisen, befestigt. LED-Platinen lassen sich in verschiedenen Positionen montieren. Betriebsgeräte verschwinden unter einer Abdeckung. Stilvolle Wandleuchten für indirekte Beleuchtungen lassen sich mit dem Profil umsetzen.

Small luminaire, big effect - a perfect alternative to drywall coving

The **NauticProfil® W2** is an elegant, flat alternative to drywall coves and is fixed to the wall by means of mounting plates or magnetic holders, e.g. on iron T-beams. LED boards can be mounted in different positions. Control gear disappears under a cover. Stylish wall lights for indirect lighting can be implemented with the profile.

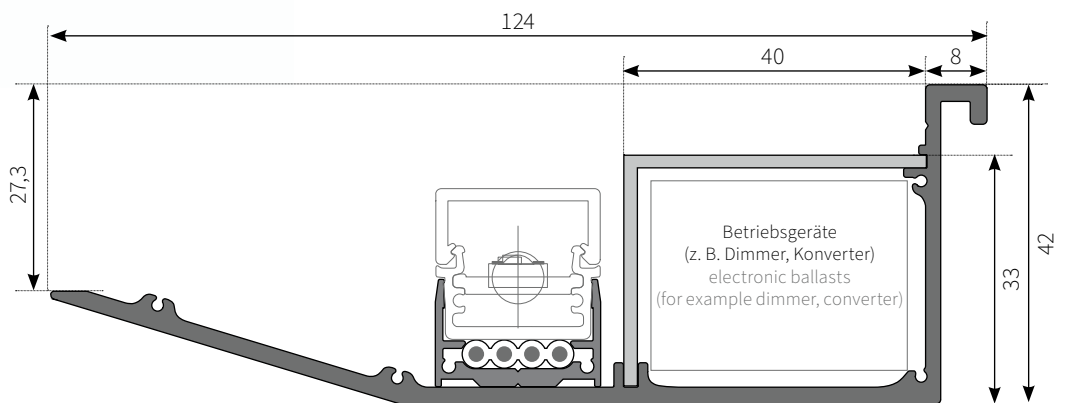
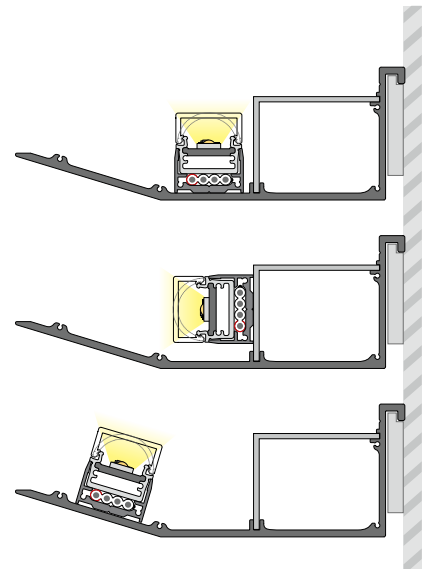
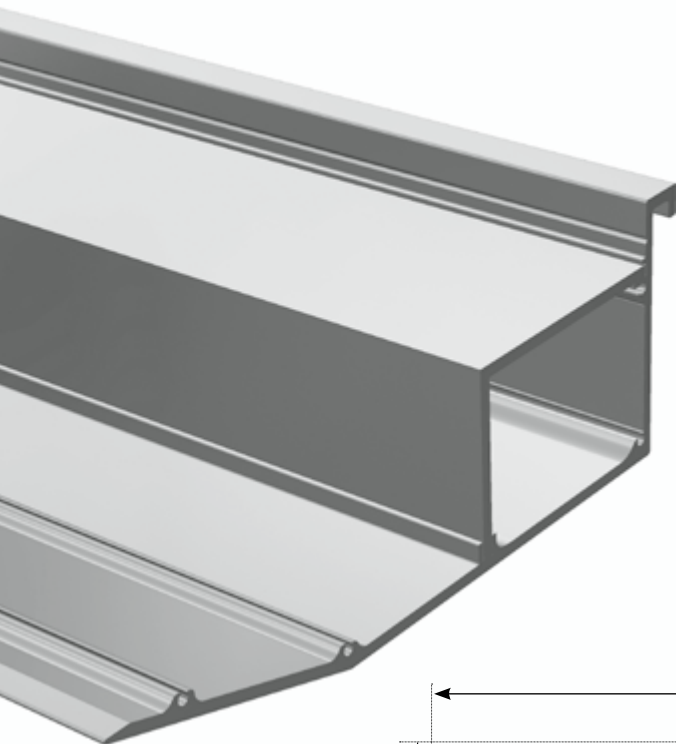

 .../ALA
alu anodized (standard)
E6EV1

 .../BA
black anodized
E6C14

 .../TWP
RAL 9016 traffic white
fine structure (powdered)

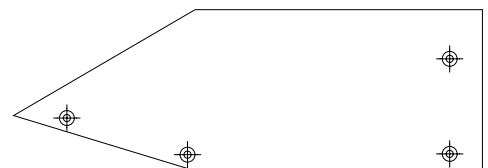

Endplatte NP W1; Maßstab 1:2
end plate NP W1; Scale 1:2

Sonderfarben auf Anfrage! Special colours on request!

Bitte bei NP Profil- und Endplatten-Bestellung die Art.Nr. um die gewünschte Farbe ergänzen. Bei gewünschtem Gehrungsschnitt die Art.Nr. um die Gradzahl, bei Bestellung des NP Flachkabels die Art.Nr. um die entsprechende Länge (mm) ergänzen. Bitte beachten Sie unser Formular für NauticProfil® Eck-Konfigurationen im Katalog und unter www.flashaar.de

Maßstab 1:1 / Alle Maßangaben in mm.
scale 1:1 / All dimensions in mm.

Please state the required colour with the article number when ordering NP profiles and end plates. Please state the required angle with the article number when ordering bevel cuts and state the corresponding length (mm) with the article number when ordering NP flat cables. Please take note of our form for NauticProfil® corner-connections and also at www.flashaar.de



© Sauna Leonberg / Altana GmbH

Bestellnummer
item number

NP/W2-MP / 2010 / ###

Befestigung
fasteners

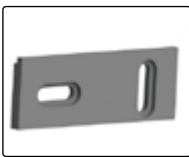

FLNP/W-PLATE/ALA
(90 x 31 x 5 mm)
Befestigungsplatte für NP-W Montageprofil
mounting plate for NP-W mounting profile

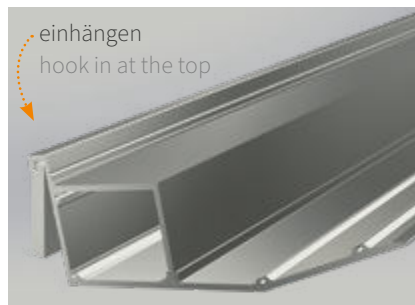

magnetische Befestigung auf Anfrage
magnetic mounting on request

Artikel, Zubehör und Optionen
articles, accessories and options



NP/W2-MP/2010/###
(0510 /1010 /2010 oder 3020 x 124 x 42 mm)
NP-W2 Aluminium Montageprofil (indirekt)
NP-W2 aluminium mounting profile (indirect)

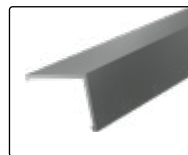

FLNP/W-L/2010/###
(30 x 40 x 2010 mm)
Aluminium Winkel (standardmäßig inklusive)
angle aluminium (included as standard)

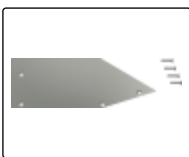

FLNP/W2-EP/L/1/###
(2 x 124 x 42 mm)
Aluminium Endplatte für NP-W2 Montageprofil (links)
aluminium end plate for NP-W2 mounting profile (left)

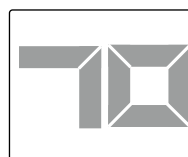

FL/B-CUT
Gehrungsschnitt für L-, U- oder Q-Konfiguration
bevel cut for L-, U- or Q-configuration

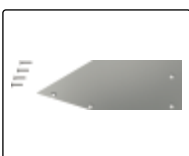

FLNP/W2-EP/R/1/###
(2 x 124 x 42 mm)
Aluminium Endplatte für NP-W2 Montageprofil (rechts)
aluminium end plate for NP-W2 mounting profile (right)



FLNP/FCable-UV
(4x2,5/3,45 mm²/0,122 kg/m)
NP Flachkabel 4 x 2,5 mm², UV-beständig
NP flat cable 4 x 2,5 mm², UV resistant

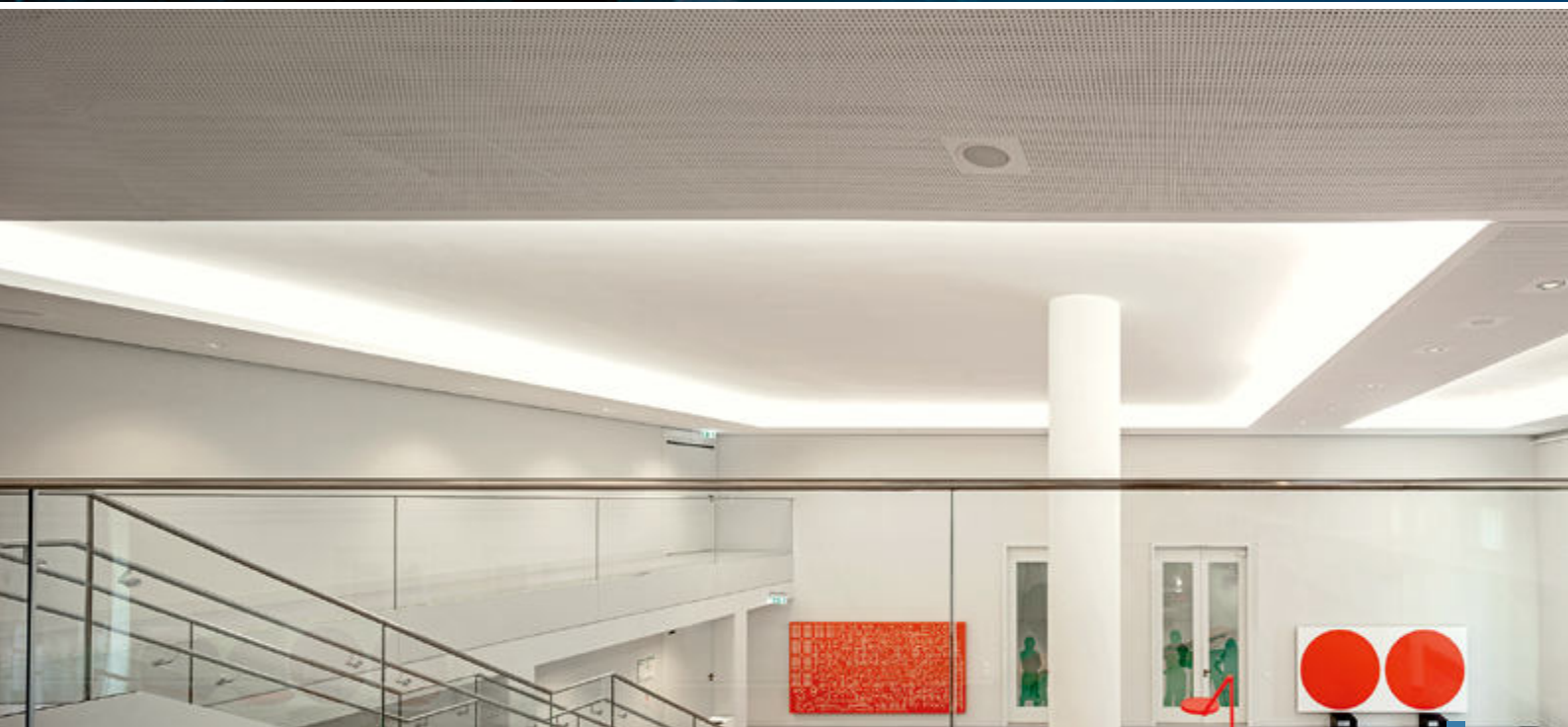

Humboldt Akademie

Großformatige Lichtvouten, bestückt mit NauticProfil® Leuchten, prägen das Erscheinungsbild der Humboldt Akademie.

Die Akademie ist ein Ausbildungsraum, bei deren Planung die Flexibilität der Raumnutzung wichtig war. Die Schwerpunkte der Akademie sind die temporären Ausstellungen und die Dauerausstellungen zur Geschichte des Ortes.

Humboldt Academy

Large-format light covers fitted with NauticProfile® luminaires characterise the appearance of the Humboldt Academy.

The academy is an educational institution in whose planning the flexible use of space played an important role. The focal points of the academy are the temporary exhibitions and the permanent exhibitions on the history of the site.



NP Extension-1 G1

Schwenkbare Lichtlinien für flexible Beleuchtung

Die **NP Extension-1 G1** ermöglicht es, die Leuchte in 15°-Schritten im Bereich von -105° bis +105° zu neigen. Damit kann der NP Leuchteneinsatz in der Neigung optimal an verschiedene Beleuchtungsanforderungen angepasst werden. Im NP Extension-1 G1 sitzt eine Buchse, in welche die komplett vormontierten NP Leuchteneinsätze aus unserem Portfolio, dank des bewährten Plug&PlayPrinzips, schnell und einfach mit ihren Piercingkontakten "eingeklickt" werden. Ein Austausch der NP Leuchteneinsätze ist ebenfalls problemlos möglich.

Swivel-mounted light lines for flexible lighting

The **NP Extension-1 G1** allows the luminaire to be tilted in 15° steps in the range from -105° to +105°. This makes it easy to adapt the NP light insert to different lighting requirements. The NP Extension-1 G1 contains a socket into which the completely pre-assembled NP light inserts from our portfolio are quickly and easily „clicked“ with their piercing contacts, thanks to the proven Plug&Play principle. The NP light inserts can also be exchanged without any problems.

Bestellnummer
item number

FLNP/E1/105G1 / XXX



TIPP
Leuchteneinsatz schwenkbar, 15° Schritte
light insert pivotable, 15° steps

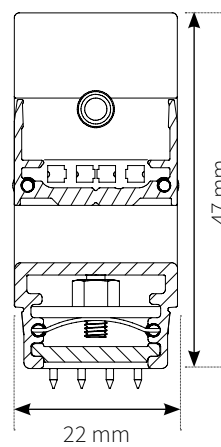
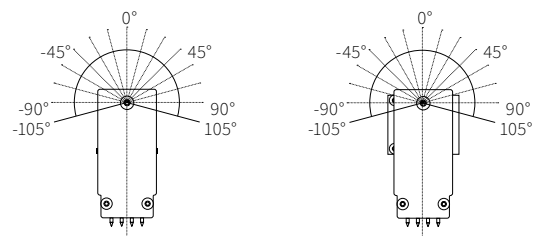

Maßstab 1:1 / Alle Maßangaben in mm.
scale 1:1 / All dimensions in mm.

Sonderfarben auf Anfrage! Special colours on request!

 ... /ALA
alu anodized (standard)
E6EV1

 ... /BA
black anodized
E6C14

 ... /TWP
RAL9016 traffic white
fine structure (powdered)



NP Extension-1 G2

Schwenkbare, flexible Beleuchtung ohne Blendung

Auch unsere **NP Extension-1 G2** ermöglicht es, die Leuchte in 15°-Schritten im Bereich von -105° bis +105° zu neigen. Durch die zusätzliche seitliche Entblendung der NP Leuchteneinsätze im Grundprofil-2, wird ein UGR < 19 ermöglicht.

Im NP Extension-1 G2 sitzt eine Buchse, in welche die komplett vormontierten NP Leuchteneinsätze aus unserem Portfolio, dank des bewährten Plug&Play Prinzips, schnell und einfach mit ihren Piercingkontakten "eingeklickt" werden. Ein Austausch der NP Leuchteneinsätze ist ebenfalls problemlos möglich.

Swivel-mounted, flexible lighting without glare

Our **NP Extension-1 G2** also allows the luminaire to be tilted in 15° steps in the range from -105° to +105°. Thanks to the additional lateral glare control of the NP light inserts in the basic profile-2, a UGR < 19 is possible.

The NP Extension-1 G2 contains a socket into which the completely pre-assembled NP light inserts from our portfolio are quickly and easily „clicked“ with their piercing contacts, thanks to the proven Plug&Play principle. The NP light inserts can also be exchanged without any problems.

Bestellnummer
item number

FLNP/E1/105G2 / XXX



TIPP

Leuchteneinsatz schwenkbar, 15° Schritte
light insert pivotable, 15° steps

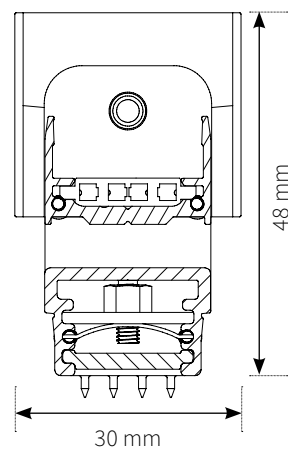
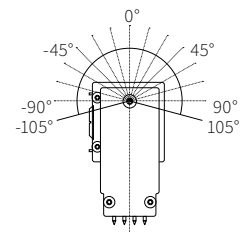
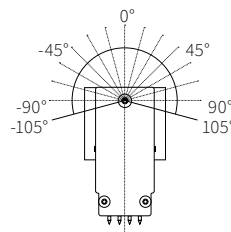

Die seitliche Entblendung ermöglicht einen UGR < 19.
The lateral glare control enables a UGR < 19.

Maßstab 1:1 / Alle Maßangaben in mm.
scale 1:1 / All dimensions in mm.

Sonderfarben auf Anfrage! Special colours on request!



... /ALA
alu anodized (standard)
E6EV1



... /BA
black anodized
E6C14



... /TWP
RAL9016 traffic white
fine structure (powdered)



mounting







NauticProfil® Leuchteneinsätze

NauticProfil® light inserts

NauticProfil® Leuchteneinsätze

NauticProfil® light inserts

In zahlreichen Projekten bewährt: Die NauticProfil® Leuchteneinsätze liefern perfektes lineares Licht für vielfältige Anwendungen. Dafür sorgen eine große Auswahl an LED-Bestückungen und Lichtcharakteristiken sowie die verfügbaren Cover und Linsen. Bis zu 120 Meter lange Lichtlinien lassen sich mit den NauticProfil® Leuchteneinsätzen und dem patentierten Plug&Play Montageprinzip mit einer elektrischen Einspeisung realisieren.

Bei den LED setzen wir hauptsächlich auf Alukern-Platinen, die in Deutschland speziell für uns bestückt werden. Sie bieten eine optimale Kühlung und beste Lichtausbeute, lange Lebensdauer und niedrige Ausfallraten. Dazu tragen auch die robusten und hochwertigen Aluminium-Leuchteneinsätze mit optimalen Wärmeleiteigenschaften bei. Sie sind auf Wunsch mit IP-Schutz erhältlich, zertifiziert gemäß DIN EN 60529:2014.

Unsere hauseigene Polyurethan-Vergussmaschine ermöglicht die Versiegelung der NauticProfil® Leuchteneinsätze zum Schutz vor Feuchtigkeit, Staub, Vibration und mechanischer Beanspruchung. **Unterschiedliche Vergussfarben und Härtegrade, von weich, kratzfest bis glashart, sind realisierbar.**

Tried-and-tested in many projects: light inserts in NauticProfil® series create perfect linear light for a wide variety of uses. This versatility is achieved with the help of a large selection of LED configurations and light characteristics as well as with the choice of available covers and lenses. The light inserts in the NauticProfil® range and the patented Plug&Play method of installation make it possible to realise lines of light that are up to 120 metres long from a single electrical feed.

We mainly use circuit boards for our LED that possess an aluminium core and that are assembled especially for us in Germany. The use of aluminium helps optimum cooling to be achieved along with best luminous efficiency, long life spans and low failure rates. The robust high-quality aluminium light inserts with optimum heat conducting properties also contribute to these features. The inserts are also available on request with IP protection certified in compliance with DIN EN 60529:2014.

We also operate our own encapsulation machine so that we are able to seal our NauticProfil® light inserts and protect them against moisture, dust, vibrations and mechanical loads. Different potting colours and degrees of hardness, from soft, scratch-resistant to glass-hard, can be realised.

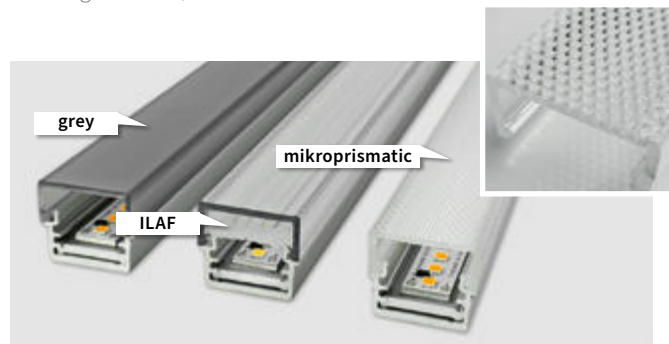

Cover und Linsen

cover and lenses

Die FLASHAAR® NauticProfil® Leuchteneinsätze sind mit Covern in runder, eckiger und flacher Ausführung und jeweils 120° Abstrahlungswinkel erhältlich. Außerdem stehen verschiedene Linsen mit symmetrischer und asymmetrischer Lichtabstrahlung zur Auswahl.

Eine Besonderheit ist das Cover „grey“: es bietet den Effekt bei ausgeschalteter Leuchte schwarz zu wirken und nicht einsehbar zu sein.

Unsere **neue asymmetrische Linse „ILAF“** ist optimiert auf den Einsatz im Handlauf in Kombination mit einem schlagzähen oder UV-beständigen eckigem Cover und unserem einzigartigen PremiumCoating. Die Haptik in einem Handlauf wird nicht gestört durch eine aus dem Nutrohr herausragende Linearlinse. Unser eckiges Cover ermöglicht einen flächigen, glatten und sauberen Abschluss der Nut.

Ebenfalls neu ist das **Cover mit Mikroprismatik**, welches eine ausgezeichnete Lichtausbeute bei geringer Blendung garantiert.

Verschiedene Farben und **vandalismugeschützte Ausführungen** (schlagfest gemäß IK10) aus Polycarbonat runden das Angebot ab.

FLASHAAR's light inserts in the NauticProfil® series are available with round, rectangular and flat covers, each with a 120° light distribution. A selection of lenses with symmetrical and asymmetrical beams is also available to choose from.

A special feature is the grey cover: it offers the possibility to make the black luminaire invisible when the light is turned off.

Our new **asymmetric lens „ILAF“** is optimised for use in the handrail in combination with an impact-resistant or UV-resistant square cover and our unique PremiumCoating. The feel in a handrail is not disturbed by a linear lens protruding from the groove tube. Our angular cover enables a flat, smooth and clean finish to the groove.

















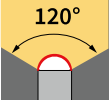

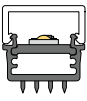
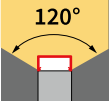

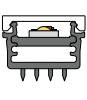
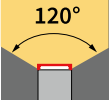

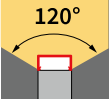

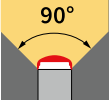

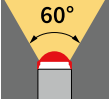

Also new is the cover with **micro prismatic**, which guarantees excellent light output with low glare.

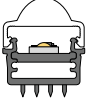
Different colours along with versions made from polycarbonate that are **protected against vandalism** (impact-resistant in accordance with IK10) round off the spectrum.

Zu allen Leuchteneinsätzen finden Sie aktuelle Lichtverteilungskurven – vermessen im FLASHAAR® Lichtlabor – unter <https://flashaar.de>.
You will find the current light-distribution curves for all the light inserts – measured in FLASHAAR's own light laboratory – at <https://flashaar.de>.

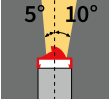
Übersicht der Cover und Linsen

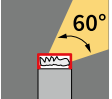
overview of covers and lenses

	Bauform design	Abstrahlwinkel beam angle	Abstrahlverhalten radiation characteristics	Coverfarben & Transmissionsgrad* cover colours & transmittance*					Material material
				 transparent	 frosted	 white	 grey	 mikro-prisma	
cover round		CR 		94%	90%	40%	–	–	PMMA (Standard) PC**
cover square		CS 		91%	83%	47%	33%	73%	PMMA (Standard) PC**
cover flat		CF 		87%	79%	44%	–	–	PMMA (Standard) PC**
cover square mikroprismatic		CSM 		–	–	–	–	73%	PMMA (Standard)
lens 90°		L9 		92%	88%	–	–	–	PMMA (Standard) PC**
lens 60°		L6 		93%	88%	–	–	–	PMMA (Standard) PC**
lens 30°		L3 		89%	84%	–	–	–	PMMA (Standard) PC**
lens 15°		L1 		–	84%	–	–	–	PMMA (Standard)
lens LAF-2 asymmetric		LA 		–	84%	–	–	–	PMMA (Standard)
lens ILAF asymmetric (IP65)		ILA IP65 PRECISION 		–	83%	–	–	–	PMMA (Standard)

PMMA: Polymethylmethacrylat (Kurzzeichen PMMA, auch Acrylglas) ist ein transparenter thermoplastischer Kunststoff.
PMMA: Polymethylmethacrylate also known as acrylic, acrylic glass is a transparent thermoplastic.

* Bei den dargestellten Werten handelt es sich um Durchschnittswerte. Der tatsächliche Wirkungsgrad mit Cover bzw. Linse ist auch von der Geometrie des Profils und der LED-Serie abhängig.
Für exakte Angaben beachten Sie hierzu bitte die photometrischen Vermessungen (ldt, ies) unter <https://flashaar.de>.
The values shown are average values. The actual efficiencies with covers and lenses also depend on the geometry of the profiles and the LED series.
Please refer to the photometric measurements (ldt, ies) at <https://flashaar.de> for precise details.

** Polycarbonat (PC): schlagfest IK10, vandalismussicher. Details auf Anfrage.
Polycarbonate (PC): impact resistant IK10, vandalism-proof. Details on request.

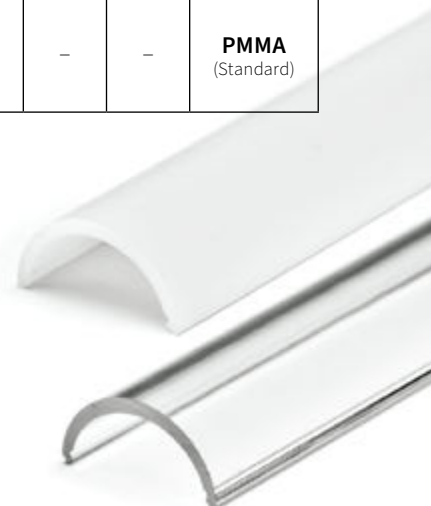

Klassische Anwendungen für Lineare Leuchten

classic applications for linear lighting

Erst Licht ermöglicht es dem Menschen Räume wahrzunehmen. Mit Licht lässt sich die Architekturwahrnehmung beeinflussen. Licht erweitert und akzentuiert Räume, schafft Verbindungen und grenzt Bereiche voneinander ab.

Only light enables humans to perceive space. It also is able to influence the perception of architecture. Light enlarges and accentuates rooms as much as it is able to connect areas and to separate them into sections.

Voutenbeleuchtung

cove lighting

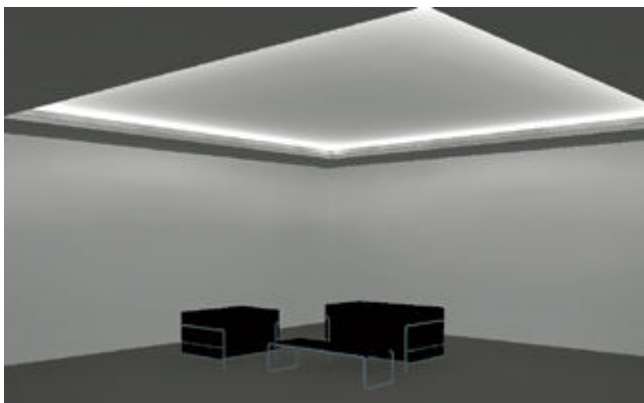

Deckenvoute mit Lichtrichtung nach innen
ceiling cove with light direction inwards

Wirkung: Die Voutenbeleuchtung hellt die Decke auf und gibt gleichzeitig dem gesamten Raum eine plastische Großzügigkeit. Der Raum wirkt höher und die Raumzonen sind klar definiert. Diese Art der Voutenbeleuchtung schafft eine ausgewogene, weiche und schattenfreie Grundbeleuchtung.

Hinweis: Eine homogene Ausleuchtung ohne Hell-Dunkel-Bereiche an einer reflektierenden Deckenoberfläche wird erreicht unter Verwendung von LED-Linien mit einer hohen Gleichmäßigkeit kombiniert mit weißem oder gefrostetem Cover und/oder durch einen tief zurückversetzten Einbau. Für die Grundbeleuchtung eine lichtstarke LED-Serie einsetzen.

Effect: The cove lighting brightens up the ceiling, also giving a three-dimensional spaciousness to the room as a whole. Thus, the ceiling appears higher and the room zones are clearly defined. This type of cove lighting creates a balanced, soft and shadow-free basic illumination.

Note: To receive a homogeneous illumination above a reflecting surface without light and dark areas, we recommend the use of LED lines with a high level of uniformity, combined with a white or frosted cover and/or a deep installation in a set back position. For basic illumination, use a light-intense LED series.

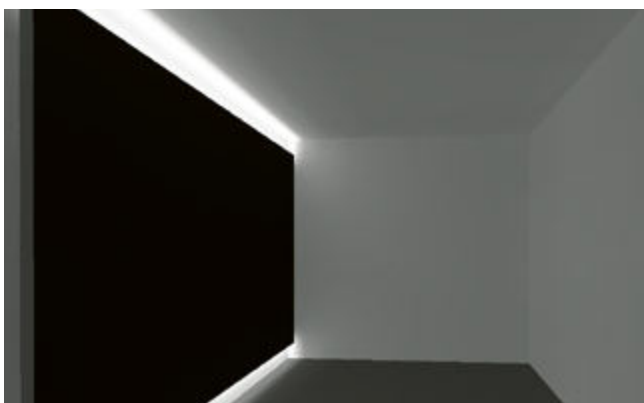

Hinterleuchtung einer vorgesetzten Wandfläche
backlighting of a superior wall surface

Wirkung: Kontrastreiche Ablösung der Wandfläche von Boden und Decke.

Hinweis: Eine homogene Ausleuchtung ohne Hell-Dunkel-Bereiche an einer reflektierenden Wandoberfläche wird erreicht unter Verwendung von LED-Linien mit einer hohen Gleichmäßigkeit kombiniert mit weißem oder gefrostetem Cover und/oder durch einen tief zurückversetzten Einbau.

Effect: Contrasting detachment of the wall surface against the floor and ceiling.

Note: To receive a homogeneous illumination above a reflecting surface without light and dark areas, we recommend the use of LED lines with a high level of uniformity, combined with a white or frosted cover and/or a deep installation in a set back position.



Deckenvoute mit Lichtrichtung nach außen
ceiling cove with light direction to the outside

Wirkung: Die Voutenbeleuchtung erhellt umlaufend den Deckenfries und das abgesetzte innere Deckenfeld bleibt dunkel. Die Raumproportion wird mit Licht nachgezeichnet. Der Raum wirkt optisch größer.

Hinweis: Eine homogene Ausleuchtung ohne Hell-Dunkel-Bereiche an einer reflektierenden Deckenoberfläche wird erreicht unter Verwendung von LED-Linien mit einer hohen Gleichmäßigkeit kombiniert mit weißem oder gefrostedem Cover und/oder durch einen tief zurückversetzten Einbau.

Effect: The cove lighting brightens up the ceiling frieze while the sticking out inner ceiling panel remains unlit. The proportions of the room are retraced with light, so it appears optically larger as a whole.

Note: To receive a homogeneous illumination above a reflecting surface without light and dark areas, we recommend the use of LED lines with a high level of uniformity, combined with a white or frosted cover and/or a deep installation in a set back position.

Sockelbeleuchtung pedestal lighting

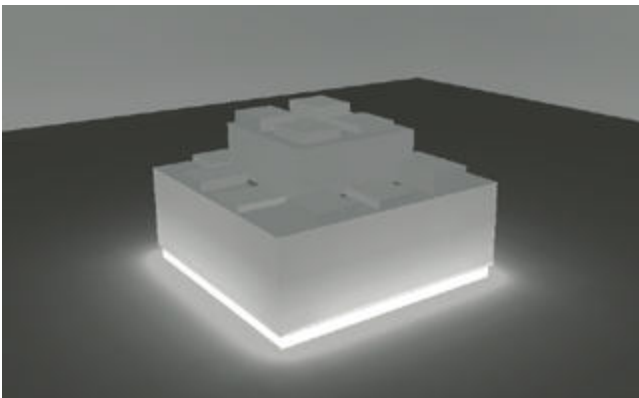

Homogene Sockelbeleuchtung
homogeneous pedestal lighting

Wirkung: Licht-Insel

Hinweis: Eine homogene Ausleuchtung ohne Hell-Dunkel-Bereiche über einer reflektierenden Bodenoberfläche wird erreicht unter Verwendung von LED-Linien mit einer hohen Gleichmäßigkeit kombiniert mit weißem oder gefrostedem Cover und/oder durch einen tief zurückversetzten Einbau.

Effect: Light pools

Note: To receive a homogeneous illumination above a reflecting surface without light and dark areas, we recommend the use of LED lines with a high level of uniformity, combined with a white or frosted cover and/or a deep installation in a set back position.

Pendelleuchte pendant luminaire

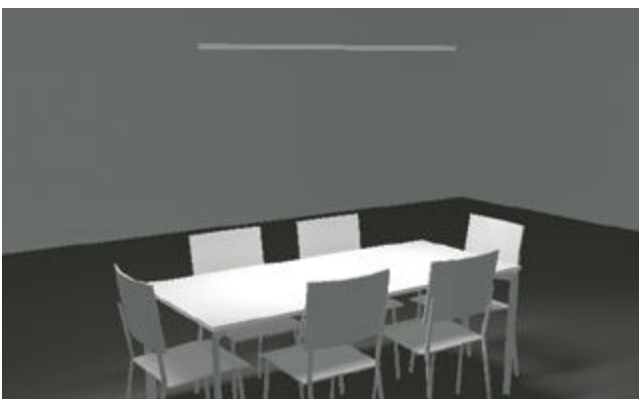

Abgependelte LED-Linie
suspended LED line

Wirkung: Tischbezogene Beleuchtung.

Hinweis: Auf eine ausreichende Beleuchtungsstärke ist zu achten. Wenn die Tischplatte glatt ist, kann es zu störenden Reflexionen kommen, was durch die Verwendung eines weißen Covers vermieden wird.

Effect: LED lighting customised to the table.

Note: We recommend the use of LED with a sufficient level of luminous flux. If the table top is smooth, it can cause disturbing reflections, which can be avoided by the use of a white cover.

Regal- und Tischvitrinenbeleuchtung shelf and table showcase lighting



Wirkung: Höchste Helligkeitszone an der Fachvorderkante und sehr gleichförmige Ausleuchtung des zurückgesetzten Objektes.
Hinweis: Bei qualitativ hochwertigen Exponaten LED mit hoher Farbwiedergabe verwenden.

Effect: With the highest light zone being at the front edge of the shelf, the set back object is illuminated very uniformly.

Note: For the illumination of highly qualitative exhibits, we recommend the use of LED with a high level of colour rendering.



Wirkung: Höchste Helligkeitszonen beidseitig. Schattenfreie Beleuchtung des Objektes.
Hinweis: Bei qualitativ hochwertigen Exponaten LED mit hoher Farbwiedergabe verwenden.

Effect: With the highest light zones being on both sides, a shadow-free illumination can be provided.

Note: For the illumination of high quality exhibits, we recommend the use of LED with a high level of colour rendering.

Direkte Beleuchtung direct Lighting



Wirkung: Das Licht wird direkt in den Raum und auf die Nutzebenen gelenkt oder auf Plätze, wo es gebraucht wird. Eine lange sichtbare Linie kann z. B. als Lichtführung dienen, kurze Linien können auch dekorative Elemente sein.

Hinweis: Je nach Bedarf stehen verschiedene Linsen/Cover zur Verfügung. Direktes Licht erzeugt jedoch Schatten, kann blenden und reflektieren.

Effect: The light is channeled directly into the room and onto the working planes or places where it is needed. A long visible line may be used as a light guide, short lines can also be decorative elements.

Note: Depending on your requirements, different lenses/covers are available. Direct light creates shadows, can glare and be reflected.

Treppenbeleuchtung stairway lighting



Wirkung: Homogene wegeföhrende Beleuchtung.

Hinweis: Grundsätzlich sind alle LED Leuchten zur Integration in die Notbeleuchtung geeignet.

Effect: Homogeneous and guiding illumination of the stairways.

Note: Basically, all manners of LED lights are suitable for integration in emergency lighting.

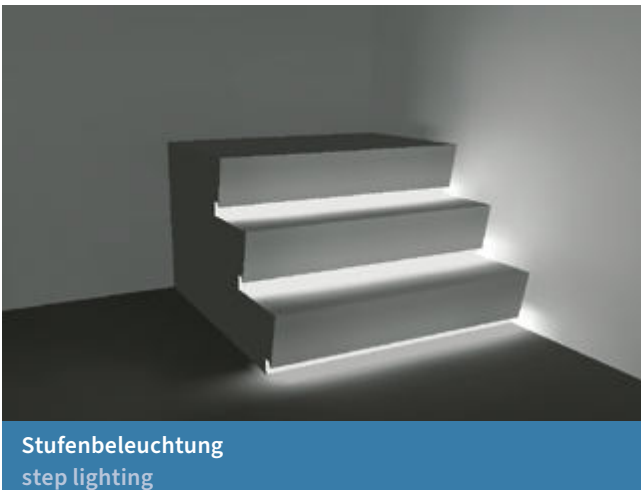

Wirkung: Starke Akzentuierung der Treppenanlage.

Hinweis: Um eine homogene Ausleuchtung über einer reflektierenden Bodenoberfläche zu erzielen, empfehlen wir die Verwendung von LED-Linien mit einer hohen Gleichmäßigkeit. Die Kombination mit einem weißem oder gefrostetem Cover und /oder ein tief zurückversetzter Einbau vervollständigen die Wirkung.

Effect: The stairway is strongly accentuated.

Note: To receive a homogeneous illumination above a reflecting surface, we recommend the use of LED lines with a high level of uniformity, combined with a white or frosted cover and/or a deep installation in a set back position.

NauticProfil® LED Serien

NauticProfil® LED series

Derzeit stehen 8 FLASHAAR® NauticProfil® LED-Serien mit unterschiedlicher LED-Bestückung und Lichtcharakteristik zur Auswahl.

Jede Variante ist mit unterschiedlichen Lichtfarben, Optiken und Längen konfigurierbar.

	NP Mayflower-3	NP Sta. Maria-6	NP Victory-7	NP Navigator-3
Nr. LED-Typ	10C	01E	03F	14C
Seite/page	88	92	98	104
Anzahl an Kanälen und Lichtfarbe/ number of channels and luminous colour				
channels & luminous colour	1CH - white (WW/NW/DL)	1CH - white (WW/NW/DL)	1CH - white (WW/NW/DL)	1CH - white (WW/NW/DL)
dimming type	PWM	PWM	PWM	PWM
Lichtstrom/ luminous flux typ				
WW 2200 K	278 lm/m	578 lm/m	852 lm/m	1326 lm/m
WW 2400 K	-	-	-	-
WW 2700 K	302 lm/m	654 lm/m	1282 lm/m	1576 lm/m
WW 3000 K	326 lm/m	680 lm/m	1324 lm/m	1618 lm/m
NW 4000 K	350 lm/m	724 lm/m	1420 lm/m	1704 lm/m
DL 5600 K	-	-	-	-
DL 6500 K	358 lm/m	714 lm/m	1476 lm/m	1644 lm/m
RGB	-	-	-	-
Farbwiedergabe/ colour rendering index				
CRI	> 90	> 90	> 90	> 80
Elektrische Spezifikation/ electric specifications				
voltage DC	24V DC (21,45 to 25,5V DC)	48V DC (44,25 to 49,5V DC)	48V DC (44,25 to 49,5V DC)	48V DC (44,25 to 49,5V DC)
power/ meter typ.	2,4 W/m	4,8 W/m	9,6 W/m	9,6 W/m
luminous efficiency typ. @Tj 55°C/2700 K	124 lm/W	133 lm/W	131 lm/W	155 lm/W
current/ meter typ.	0,1 A	0,1 A	0,2 A	0,2 A
Gleichmäßigkeit*/ uniformity*				
LED pitch	14,28 mm	6,64 mm	6,64 mm	6,64 mm
LEDs per meter	70	150	150	150
length dividing matrix	100 mm	100 mm	100 mm	100 mm
IP Schutzart/ IP rating				
	IP40, IP65, IP65 Premium			
max. Länge/ max. length per feed-in	99 m	100 m	70 m	72 m
Betriebstemp./ operating temp.	-20°C bis +45°C	-20°C bis +45°C	-20°C bis +45°C	-20°C bis +45°C

* Die Gleichmäßigkeit ist abhängig vom Abstand der einzelnen LED-Punkte und der Transluzenz des Covers bzw. der Linse.

* Uniformity depending on LED pitch and translucency of the cover/lens.

NauticProfil® LED Serien

NauticProfil® LED series

A total of 8 light inserts with various LED configurations and light characteristics are currently available in FLASHAAR's NauticPro-

fil® Line series. Each version may be configured in different light colours, covers, lenses and lengths.

	NP Jago-2	NP Nova-6	NP Pegasus-4	NP Defiant
Nr. LED-Typ	19B	06F	09D	22A
Seite/page	110	116	122	132
Anzahl an Kanälen und Lichtfarbe / number of channels and luminous colour				
channels & luminous colour	1CH - white (WW/NW/DL)	1CH - white (WW/NW/DL)	2CH - tunable white (WW + DL)	3CH - RGB
dimming type	PWM	PWM	PWM	PWM
Lichtstrom / luminous flux typ				
WW 2200 K	2622 lm/m	3180 lm/m	2470 lm/m	-
WW 2400 K	-	-	-	-
WW 2700 K	3112 lm/m	3790 lm/m	2290 lm/m	-
WW 3000 K	3272 lm/m	3920 lm/m	2370 lm/m	-
NW 4000 K	3496 lm/m	4122 lm/m	2266 lm/m	-
DL 5600 K	-	-	2276 lm/m	-
DL 6500 K	3522 lm/m	4106 lm/m	2374 lm/m	-
RGB	-	-	-	R+G+B=4468 lm/m (1161 + 2572 + 735 lm/m)
Farbwiedergabe / colour rendering index				
CRI	> 90	> 80	2700 K > 90 / 5600 K > 90 2200 K > 90 / 3000 K > 90 2200 K > 90 / 4000 K > 80	-
Elektrische Spezifikation / electric specifications				
voltage DC	48V DC (44,25 to 49,5V DC)	48V DC (44,25 to 49,5V DC)	24V DC (23,5 to 26V DC)	48V DC (48 to 48V DC)
power/meter typ.	24 W/m	24 W/m	Typ I: 22 CH1 / 20 CH2 (W/m) Typ II: 28 CH1 / 22 CH2 (W/m) Typ III: 28 CH1 / 17 CH2 (W/m)	R=908 lm/m; 15,4 W G=2350 lm/m; 16,4 W B=618 lm/m; 16,4 W
luminous efficiency typ. @Tj 55°C/2700 K	128 lm/W	152 lm/W	Typ I: 101 lm/W CH1 / 113 lm/W CH2 Typ II: 84 lm/W CH1 / 109 lm/W CH2 Typ III: 84 lm/W CH1 / 135 lm/W CH2	-
current/meter typ.	0,5 A	0,5 A	2 x 1 A	R+G+B=1,05 A (0,175 A per colour)
Gleichmäßigkeit* / uniformity*				
LED pitch	6,64 mm	6,64 mm	2 x 8,30 mm	6,64 mm
LEDs per meter	150	150	2 x 60	150
length dividing matrix	100 mm	100 mm	100 mm	100 mm
IP Schutzart / IP rating				
	IP40, IP65, IP65 Premium		IP40, IP65	IP40, IP65
max. Länge / max. length per feed-in	42 m	42 m	16 m	28 m
Betriebstemp. / operating temp.				
	-20°C bis +35°C	-20°C bis +35°C	-20°C bis +35°C	-20°C bis +35°C



Landratsamt Esslingen

Zahlreiche NauticProfil® Ein- und Anbauleuchten gewährleisten im neu errichteten Verwaltungsbau des Landratsamtes Esslingen ein funktionales und energieeffizientes Licht.

Esslingen District Office

Numerous NauticProfil® recessed and surface-mounted luminaires ensure functional and energy-efficient lighting in the newly constructed administrative building of the Esslingen District Office.



NP Mayflower-3



99m per feed-in | 302 lm/m* | CRI > 90 | 2200 K-6500 K

Licht, das neben Sicherheit ein angenehmes Ambiente schafft

A light that creates a pleasant ambience in addition to safety

Die LED-Linie **NauticProfil® Mayflower-3** wurde für den Außenbereich konzipiert. Sie ist die erste Wahl, wenn kleine Lumenströme gewünscht sind. Eingesetzt in Handläufen und Geländern jeder Art, sorgt sie für Sicherheit und eine stimmungsvolle Beleuchtung.

Das NauticProfil® Mayflower-3 eignet sich hervorragend für den Einsatz in Park- und Gartenanlagen, Parkplätzen oder Tunnel und Unterführungen.

Pro Einspeisung sind Lichtlinien mit bis zu 99 m Gesamtlänge realisierbar – und das mit erstklassigem Preis-Leistungs-Verhältnis. Es stehen fünf Farbtemperatureuren zur Auswahl.

The LED line **NauticProfil® Mayflower-3** was designed for outdoor use. It is the first choice when low lumen level is desired. Used in handrails and railings of all kinds, it provides safety and atmospheric lighting. The NauticProfil® Mayflower-3 is ideal for use in parks and gardens, car parks or tunnels, and subways.

Light lines with a total length of up to 99 m in length can be realised with a first-class price-performance ratio.

Five colour temperatures can be selected.

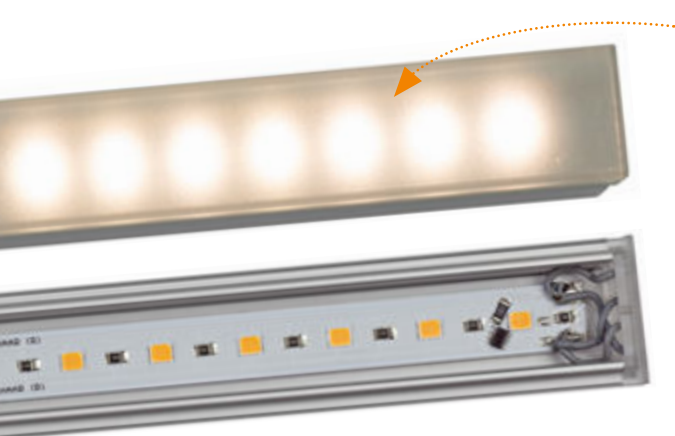

kleine Lumenströme, für stimmungsvolle Beleuchtung

small lumen currents, for atmospheric lighting

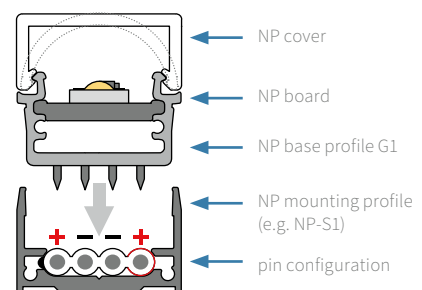
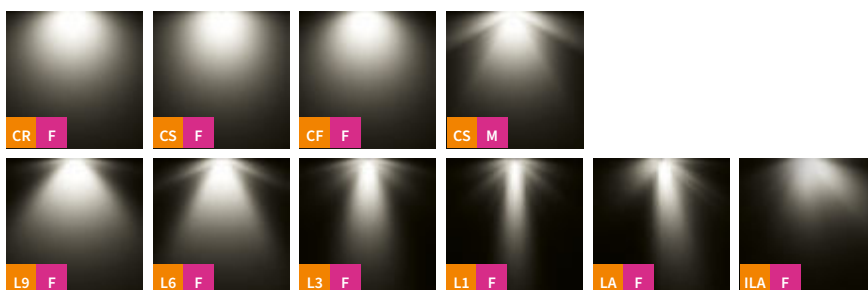

24V DC | 300g | -20/+45 | IP40

characteristics

PWM dimmable

dimming

IP65 | IP65 PREMIUM | IK10 | RAL optional

optional

mounting

* Alle Angaben zum Lumenstrom beziehen sich auf das Leuchtmittel. In Kombination mit Cover/Linsen kommt es zu materialbedingtem Lichtverlust.
All information about the luminous flux refers to the light source. In combination with covers/lenses it comes to material-related light loss.

Bestellnummer
item number

NP/L1C/G1/10C / **L1C/G1/ 112** / **G1/ ALA** / **9 27** / **CR W**

Technische Daten
technical data

nominal voltage: 24VDC (Range: 21,45 to 25,5VDC)
 nominal wattage: 2,4W/m
 photometric code: 9XX/339; CRI > 90
 luminous efficiency [typ]: 126lm/W
 LED service life: L90/B10 > 100000h
 dimmable: pulse width modulation (PWM)
 length dividing matrix: 100mm
 LED pitch: 14,28mm, 70 LEDs/m
 max. length per feed-in: L(max) DIMMED = 99m (278W)*
 2 x 16A PWM dimmer, cabling scheme D/PWM/2bb
 L(max) NOT DIMMED = 99m (278W)*,
 according to cabling scheme S/1



⚠ Alle optischen und elektrischen Daten haben eine Toleranz von +/- 10%.
 All optical and electrical data have a tolerance of +/- 10%.

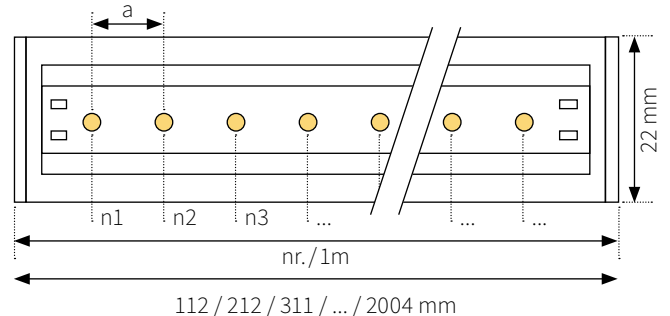

⚠* Achtung! Die Leistung [W] gesamt im NP System ist gleichmäßig auf die Kanäle 1+2 aufzuteilen.
Attention! The total power [W] in the NP system is to be divided equally between channels 1+2.

Basisprofil
base profile

Das **Basisprofil G1** ist mit allen NP Montageprofilen von FLASHAAR® per Plug&Play kombinierbar. Es ist in den Farben Aluminium (ALA) und Schwarz (BA) eloxiert erhältlich.
 The **base profile G1** can be combined with all NP mounting profiles from FLASHAAR® by Plug & Play. It is available in the colours aluminium (ALA) and black (BA) anodised.

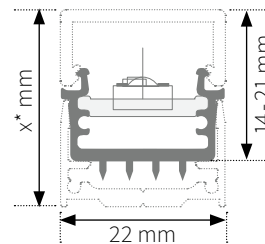

- G1/ALA (Standard)
- G1/BA

* Leuchtenhöhe abhängig vom Montageprofil (21-168 mm), Maße ab S. 7
 luminaire height depending on mounting-profile (21-168 mm), dimensions from p. 7

Farbtemperatur und Lumenstrom
colour temperature and luminous flux

Farbtemperatur colour temperature	WW 2200 K**	WW 2700 K	WW 3000 K	NW 4000 K	DL 6500 K**
CRI typ.	94	95	93	92	91
Lumenstrom typ. luminous flux* typ	278lm/m	302lm/m	326lm/m	350lm/m	358lm/m
	922	927	930	940	965

* Alle Angaben zum Lumenstrom beziehen sich auf das Leuchtmittel. In Kombination mit Cover/Linsen kommt es zu materialbedingtem Lichtverlust.
 All information about the luminous flux refers to the light source. In combination with covers/lenses it comes to material-related light loss.

**Farbtemperatur auf Anfrage. Colour temperature on request.











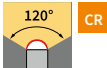
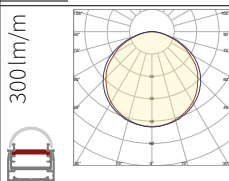
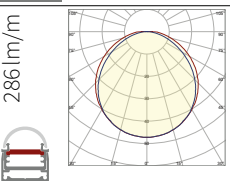
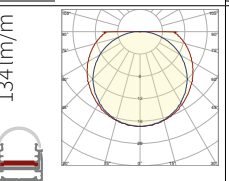
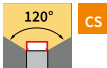
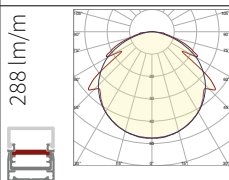
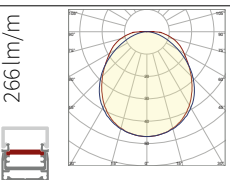
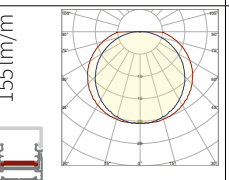
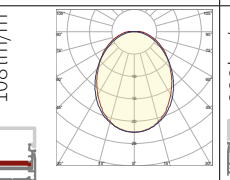
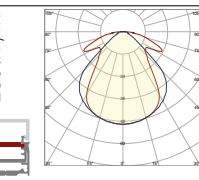
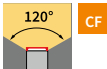
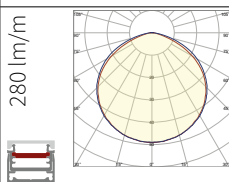
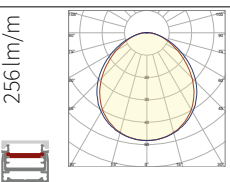
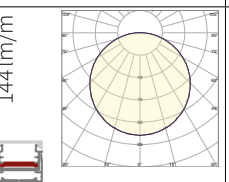
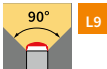
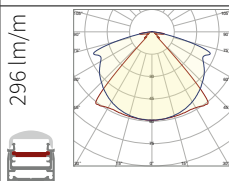
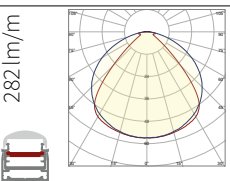

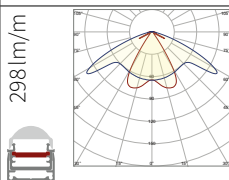
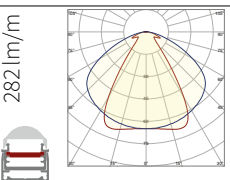
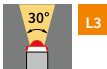
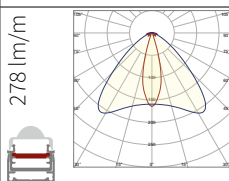
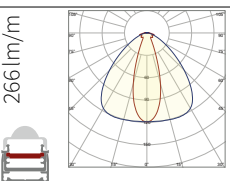
Übersicht Standardlängen & Wattagen
overview standard lengths & wattages

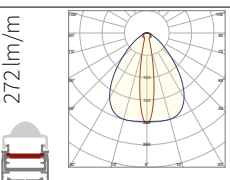
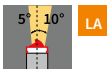
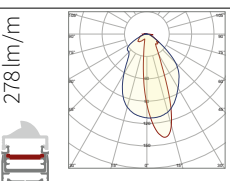
IP40, IP65, IP65 Premium		
product-nr.	L (mm)*	Watt**
NP/L1C/G1/10C/L1C/G1/0112/###/###	112	0,24
NP/L1C/G1/10C/L1C/G1/0212/###/###	212	0,48
NP/L1C/G1/10C/L1C/G1/0311/###/###	311	0,72
NP/L1C/G1/10C/L1C/G1/0411/###/###	411	0,96
NP/L1C/G1/10C/L1C/G1/0510/###/###	510	1,20
NP/L1C/G1/10C/L1C/G1/0610/###/###	610	1,44
NP/L1C/G1/10C/L1C/G1/0710/###/###	710	1,68
NP/L1C/G1/10C/L1C/G1/0809/###/###	809	1,92
NP/L1C/G1/10C/L1C/G1/0909/###/###	909	2,16
NP/L1C/G1/10C/L1C/G1/1008/###/###	1008	2,40

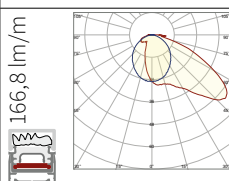
IP40		
product-nr.	L (mm)*	Watt**
NP/L1C/G1/10C/L1C/G1/1108/###/###	1108	2,64
NP/L1C/G1/10C/L1C/G1/1208/###/###	1208	2,88
NP/L1C/G1/10C/L1C/G1/1307/###/###	1307	3,12
NP/L1C/G1/10C/L1C/G1/1407/###/###	1407	3,36
NP/L1C/G1/10C/L1C/G1/1506/###/###	1506	3,60
NP/L1C/G1/10C/L1C/G1/1606/###/###	1606	3,84
NP/L1C/G1/10C/L1C/G1/1706/###/###	1706	4,08
NP/L1C/G1/10C/L1C/G1/1805/###/###	1805	4,32
NP/L1C/G1/10C/L1C/G1/1905/###/###	1905	4,56
NP/L1C/G1/10C/L1C/G1/2004/###/###	2004	4,80

⚠*Achtung! Im Außenbereich (IP65 und IP65 Premium) ist maximal ein Leuchteneinsatz in der Länge von 112mm bis 1008mm realisierbar. LED-Teilungsraster ist 100mm.
Attention! In outdoor areas (IP65 and IP65 Premium), a maximum of one luminaire insert can be realised in lengths from 112mm to 1008mm. The grid uses 100mm increments.

**Leistungsangaben +/- 10% | performance data +/- 10%

covers & lenses	T	F	W	G	M
cover round 120° 	300 lm/m 	286 lm/m 	134 lm/m 		
cover square 120° 	288 lm/m 	266 lm/m 	155 lm/m 	108 lm/m 	236 lm/m 
cover flat 120° 	280 lm/m 	256 lm/m 	144 lm/m 		
lens 90° 	296 lm/m 	282 lm/m 			
lens 60° 	298 lm/m 	282 lm/m 			
lens 30° 	278 lm/m 	266 lm/m 			
lens 15° 		272 lm/m 			
lens LAF-2 asymmetric 		278 lm/m 			
lens ILAF asymmetric (IP65 P) 	166,8 lm/m 				
<p>Alle Werte in der Tabelle gemessen bei 2700 K. Messwerte unterliegen den typischen Toleranzen. Andere Konfigurationen erhalten Sie auf Anfrage. All values in the table measured at 2700 K. Measured values are subject to the typical tolerances. Other configurations are available on request.</p> <p>Alle lichttechnischen Daten – vermessen im FLASHAAR® Lichtlabor – finden Sie unter flashaar.de im Download-Bereich. All photometric data – measured in FLASHAAR's light laboratory – find you at flashaar.de in the download area.</p> <p>Alle optischen und elektrischen Daten haben eine Toleranz von +/- 10%. All optical and electrical data have a tolerance of +/- 10%.</p> <p>Messdaten für IP65/IP65 Premium auf Anfrage. Measurement data for IP65 / IP65 Premium on request.</p>					<p>EPREL-Daten: 2200 K </p> <p>2700 K </p> <p>3000 K </p> <p>4000 K </p> <p>6500 K </p>

Verdrahtungsschemata wiring diagrams

Beispiel für max. Länge mit einer elektrischen Einspeisung.*
Example for max. length with one electrical feed.*

WD/D/PWM/1a (1x1CH)

Dimmbar mittels PWM, System mit 1 Kanal, 24VDC /
1CH Leuchteneinsätze mit redundanter PIN-Belegung
dimmbable by PWM, system with 1 channel, 24VDC /
1CH light insert with double PIN connection
max. **70 m** (196 W) pro Einspeisung / max. 70 m (196 W) per feed in

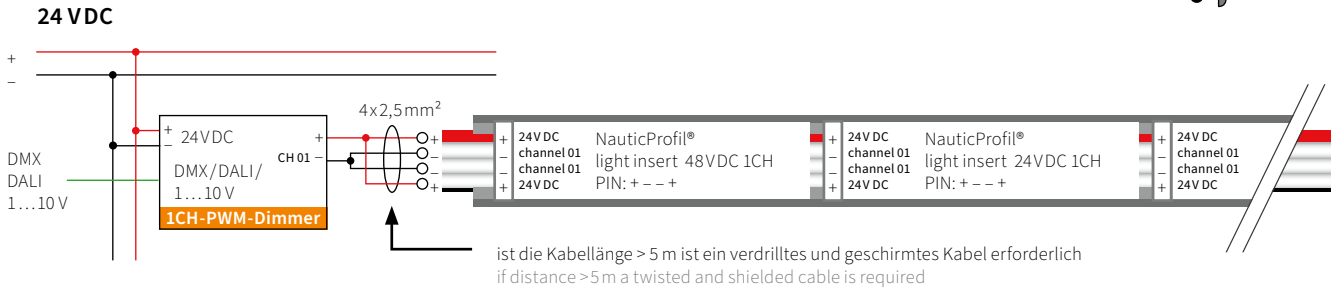
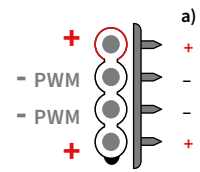

WD/D/PWM/2bb (2x1CH)

Dimmbar mittels PWM, System mit 2 Dimmern 1CH, 24 VDC /
1CH Leuchteneinsätze
dimmbable by PWM, system with 2 dimmer 1CH, 24 VDC / 1CH light insert
max. **99 m** (278 W) pro Einspeisung / max. 99 m (278 W) per feed in

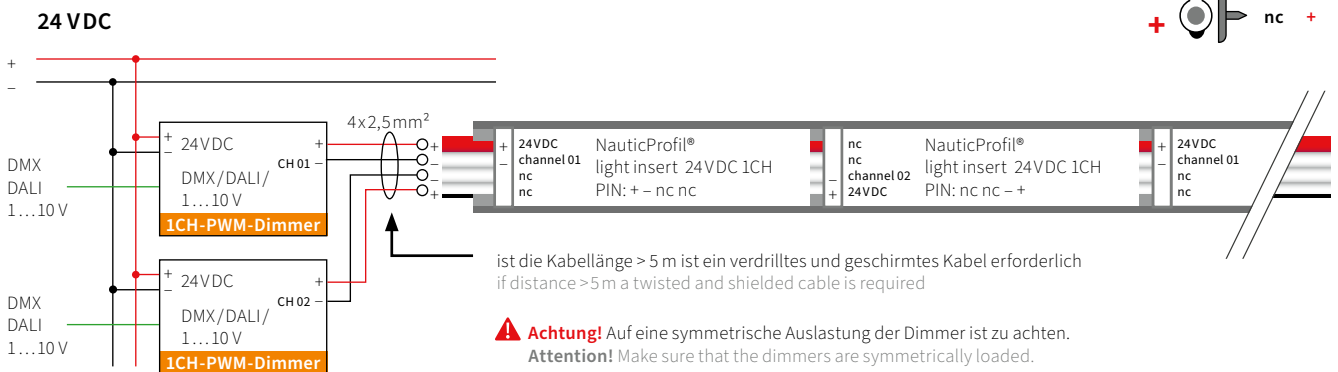
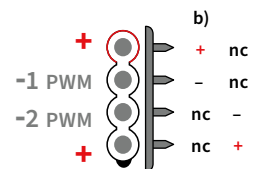

WD/S/1a (1x1CH)

Schaltbar, System mit 1 Kanal /
1CH Leuchteneinsätze mit redundanter PIN-Belegung
to switch ON/OFF, system with 1-channel /
1CH light insert with double PIN connection
max. **99 m** (278 W) pro Einspeisung / max. 99 m (278 W) per feed in

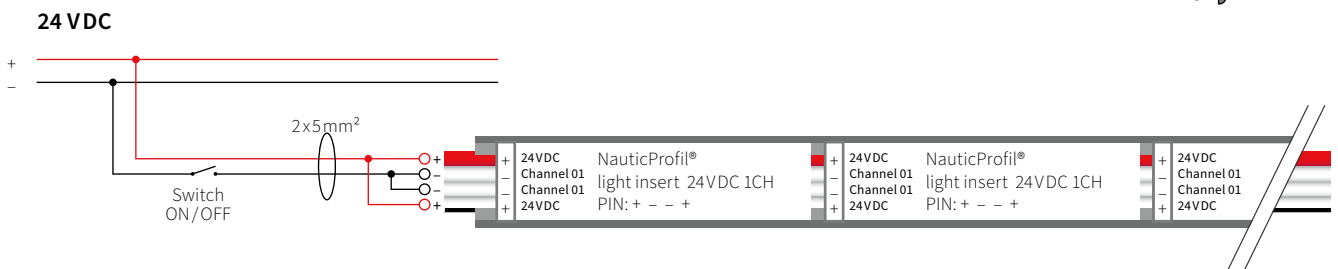
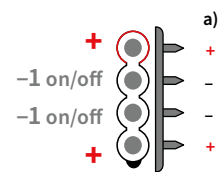

* Standard PIN-Belegung ist + - - + (WD/D/PWM/1a) / Weitere Verdrahtungsschemata in unserem aktuellen Katalog.
standard pin layout is + - - + (WD/D/PWM/1a) / Further Cabling Scheme in our current catalogue.

NP Sta. Maria-6



100m per feed-in | 654 lm/m* | CRI > 90 | 2200 K-6500 K

Hohe Lichtqualität
zum günstigen Preis
High lighting quality at an
affordable price

Dank der hohen Lichtqualität und geringem Lumenstrom, eignet sich das **NaticProfil® Sta. Maria-6** optimal für eine funktionale und dekorative Akzent- und Konturbeleuchtung. Auch für den Einsatz in Handläufen und Geländern jeder Art ist es eine sehr gute Wahl. Lichtlinien von bis zu 100m Gesamtlänge pro Einspeisung lassen sich mit dem NP Sta. Maria-6 problemlos umsetzen. Das erstklassige Preis-Leistungs-Verhältnis spricht für sich. Es stehen fünf Farbtemperaturen zur Auswahl.

Thanks to its high quality of light and its low lumen output, the **Natic-Profil® Sta. Maria-6** is ideal for a functional and decorative accent and contour lighting. It is also a very good choice for use in handrails and railings of all kinds. Light lines of up to 100 m total lengths per feeder can be easily implemented with the NP Sta. Maria-6. The first-class price-performance ratio speaks for itself. There is a choice of five colour temperatures.

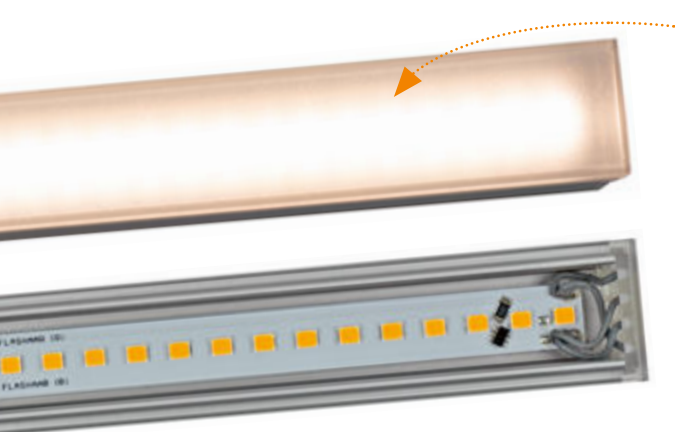

Gebäudeinszenierung
und Konturierung mit
linearen Lichtakzenten

building staging and
contouring with
linear light accents

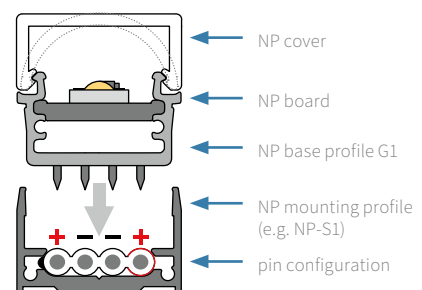
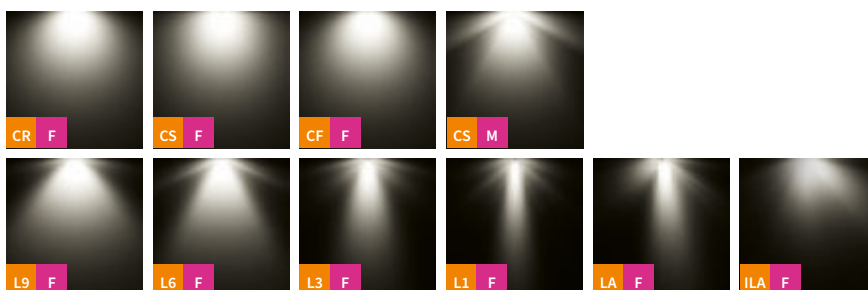

48V DC | 300g | IP40

characteristics

PWM dimmable

dimming

IP65 | IP65 PREMIUM | IK10 | RAL optional

optional

mounting

* Alle Angaben zum Lumenstrom beziehen sich auf das Leuchtmittel. In Kombination mit Cover/Linsen kommt es zu materialbedingtem Lichtverlust.
All information about the luminous flux refers to the light source. In combination with covers/lenses it comes to material-related light loss.

Bestellnummer
item number

NP/L1C/G1/01E / L1C/G1/ 112 / G1/ ALA / 9 27 / CR W

Technische Daten
technical data

nominal voltage: 48VDC (Range: 44,25 to 49,5VDC)
 nominal wattage: 4,8 W/m
 photometric code: 9XX/339; CRI > 90
 luminous efficiency [typ]: 140 lm/W
 LED service life: L90/B10 > 100000h
 dimmable: pulse width modulation (PWM)
 length dividing matrix: 100 mm
 LED pitch: 6,64 mm, 150 LEDs/m
 max. length per feed-in: L(max) DIMMED = 100 m (530 W)*
 2 x 16A PWM dimmer, cabling scheme D/PWM/2bb
 L(max) NOT DIMMED = 100 m (530 W)*,
 according to cabling scheme S/1

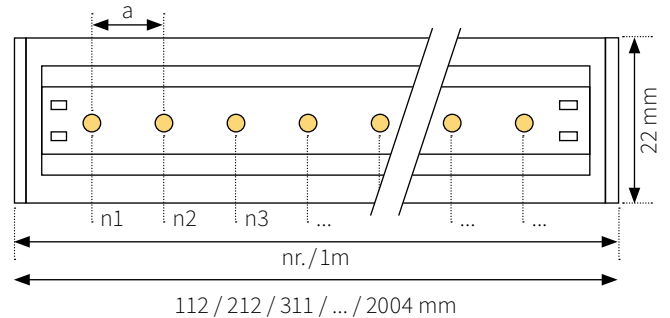

⚠ Achtung! Die Leistung [W] gesamt im NP System ist gleichmäßig auf die Kanäle 1+2 aufzuteilen.
Attention! The total power [W] in the NP system is to be divided equally between channels 1+2.

⚠ Alle optischen und elektrischen Daten haben eine Toleranz von +/- 10%.
 All optical and electrical data have a tolerance of +/- 10%.

Basisprofil
base profile

Das **Basisprofil G1** ist mit allen NP Montageprofilen von FLASHAAR® per Plug&Play kombinierbar. Es ist in den Farben Aluminium (ALA) und Schwarz (BA) eloxiert erhältlich.
 The **base profile G1** can be combined with all NP mounting profiles from FLASHAAR® by Plug & Play. It is available in the colours aluminium (ALA) and black (BA) anodised.

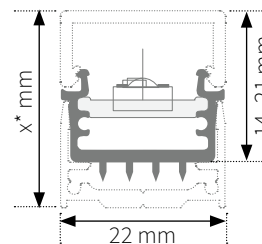

- G1/ALA (Standard)
- G1/BA

* Leuchtenhöhe abhängig vom Montageprofil (21-168 mm), Maße ab S. 8
 luminaire height depending on mounting profile (21-168 mm), dimensions from p. 8

Farbtemperatur und Lumenstrom
colour temperature and luminous flux

	WW 2200 K**	WW 2700 K	WW 3000 K	NW 4000 K	DL 6500 K**
Farbtemperatur colour temperature	WW 2200 K**	WW 2700 K	WW 3000 K	NW 4000 K	DL 6500 K**
CRI typ.	94	94	93	92	91
Lumenstrom* typ. luminous flux* typ.	578lm/m	654lm/m	680lm/m	724lm/m	714lm/m
	922	927	930	940	965

* Alle Angaben zum Lumenstrom beziehen sich auf das Leuchtmittel. In Kombination mit Cover/Linsen kommt es zu materialbedingtem Lichtverlust.
 All information about the luminous flux refers to the light source. In combination with covers/lenses it comes to material-related light loss.

**Farbtemperatur auf Anfrage.
 Colour temperature on request.

Übersicht Standardlängen & Wattagen overview standard lengths & wattages

IP40, IP65, IP65 Premium		
product-nr.	L (mm)*	Watt**
NP/L1C/G1/01E/L1C/G1/0112/###/###	112	0,48
NP/L1C/G1/01E/L1C/G1/0212/###/###	212	0,96
NP/L1C/G1/01E/L1C/G1/0311/###/###	311	1,44
NP/L1C/G1/01E/L1C/G1/0411/###/###	411	1,92
NP/L1C/G1/01E/L1C/G1/0510/###/###	510	2,40
NP/L1C/G1/01E/L1C/G1/0610/###/###	610	2,88
NP/L1C/G1/01E/L1C/G1/0710/###/###	710	3,36
NP/L1C/G1/01E/L1C/G1/0809/###/###	809	3,84
NP/L1C/G1/01E/L1C/G1/0909/###/###	909	4,32
NP/L1C/G1/01E/L1C/G1/1008/###/###	1008	4,80

IP40		
product-nr.	L (mm)*	Watt**
NP/L1C/G1/01E/L1C/G1/1108/###/###	1108	5,28
NP/L1C/G1/01E/L1C/G1/1208/###/###	1208	5,76
NP/L1C/G1/01E/L1C/G1/1307/###/###	1307	6,24
NP/L1C/G1/01E/L1C/G1/1407/###/###	1407	6,72
NP/L1C/G1/01E/L1C/G1/1506/###/###	1506	7,20
NP/L1C/G1/01E/L1C/G1/1606/###/###	1606	7,68
NP/L1C/G1/01E/L1C/G1/1706/###/###	1706	8,16
NP/L1C/G1/01E/L1C/G1/1805/###/###	1805	8,64
NP/L1C/G1/01E/L1C/G1/1905/###/###	1905	9,12
NP/L1C/G1/01E/L1C/G1/2004/###/###	2004	9,60



































Übersicht der möglichen Sonderlängen & Wattagen (nach Rücksprache) overview of possible special lengths & wattages (after consultation)

IP40, IP65, IP65 Premium		
product-nr.	L (mm)*	Watt**
NP/L1C/G1/01E/SL1C/G1/0132/###/###	132	0,96
NP/L1C/G1/01E/SL1C/G1/0152/###/###	152	0,96
NP/L1C/G1/01E/SL1C/G1/0172/###/###	172	0,96
NP/L1C/G1/01E/SL1C/G1/0192/###/###	192	1,44
NP/L1C/G1/01E/SL1C/G1/0232/###/###	232	1,44
NP/L1C/G1/01E/SL1C/G1/0252/###/###	252	1,44
NP/L1C/G1/01E/SL1C/G1/0271/###/###	271	1,44
NP/L1C/G1/01E/SL1C/G1/0291/###/###	291	1,92
NP/L1C/G1/01E/SL1C/G1/0331/###/###	331	1,92
NP/L1C/G1/01E/SL1C/G1/0351/###/###	351	1,92
NP/L1C/G1/01E/SL1C/G1/0371/###/###	371	1,92
NP/L1C/G1/01E/SL1C/G1/0391/###/###	391	2,40
NP/L1C/G1/01E/SL1C/G1/0431/###/###	431	2,40
NP/L1C/G1/01E/SL1C/G1/0451/###/###	451	2,40
NP/L1C/G1/01E/SL1C/G1/0471/###/###	471	2,40
NP/L1C/G1/01E/SL1C/G1/0491/###/###	491	2,88
NP/L1C/G1/01E/SL1C/G1/0530/###/###	530	2,88
NP/L1C/G1/01E/SL1C/G1/0550/###/###	550	2,88
NP/L1C/G1/01E/SL1C/G1/0570/###/###	570	2,88
NP/L1C/G1/01E/SL1C/G1/0590/###/###	590	3,36
NP/L1C/G1/01E/SL1C/G1/0630/###/###	630	3,36
NP/L1C/G1/01E/SL1C/G1/0650/###/###	650	3,36
NP/L1C/G1/01E/SL1C/G1/0670/###/###	670	3,36
NP/L1C/G1/01E/SL1C/G1/0690/###/###	690	3,84
NP/L1C/G1/01E/SL1C/G1/0730/###/###	730	3,84
NP/L1C/G1/01E/SL1C/G1/0750/###/###	750	3,84
NP/L1C/G1/01E/SL1C/G1/0769/###/###	769	3,84
NP/L1C/G1/01E/SL1C/G1/0789/###/###	789	4,32
NP/L1C/G1/01E/SL1C/G1/0829/###/###	829	4,32
NP/L1C/G1/01E/SL1C/G1/0849/###/###	849	4,32
NP/L1C/G1/01E/SL1C/G1/0869/###/###	869	4,32
NP/L1C/G1/01E/SL1C/G1/0889/###/###	889	4,80
NP/L1C/G1/01E/SL1C/G1/0929/###/###	929	4,80
NP/L1C/G1/01E/SL1C/G1/0949/###/###	949	4,80
NP/L1C/G1/01E/SL1C/G1/0969/###/###	969	4,80
NP/L1C/G1/01E/SL1C/G1/0989/###/###	989	5,28

IP40		
product-nr.	L (mm)*	Watt**
NP/L1C/G1/01E/SL1C/G1/1028/###/###	1028	5,28
NP/L1C/G1/01E/SL1C/G1/1048/###/###	1048	5,28
NP/L1C/G1/01E/SL1C/G1/1068/###/###	1068	5,28
NP/L1C/G1/01E/SL1C/G1/1088/###/###	1088	5,76
NP/L1C/G1/01E/SL1C/G1/1128/###/###	1128	5,76
NP/L1C/G1/01E/SL1C/G1/1148/###/###	1148	5,76
NP/L1C/G1/01E/SL1C/G1/1168/###/###	1168	5,76
NP/L1C/G1/01E/SL1C/G1/1188/###/###	1188	6,24
NP/L1C/G1/01E/SL1C/G1/1228/###/###	1228	6,24
NP/L1C/G1/01E/SL1C/G1/1248/###/###	1248	6,24
NP/L1C/G1/01E/SL1C/G1/1267/###/###	1267	6,24
NP/L1C/G1/01E/SL1C/G1/1287/###/###	1287	6,72
NP/L1C/G1/01E/SL1C/G1/1327/###/###	1327	6,72
NP/L1C/G1/01E/SL1C/G1/1347/###/###	1347	6,72
NP/L1C/G1/01E/SL1C/G1/1367/###/###	1367	6,72
NP/L1C/G1/01E/SL1C/G1/1387/###/###	1387	7,20
NP/L1C/G1/01E/SL1C/G1/1427/###/###	1427	7,20
NP/L1C/G1/01E/SL1C/G1/1447/###/###	1447	7,20
NP/L1C/G1/01E/SL1C/G1/1467/###/###	1467	7,20
NP/L1C/G1/01E/SL1C/G1/1487/###/###	1487	7,68
NP/L1C/G1/01E/SL1C/G1/1526/###/###	1526	7,68
NP/L1C/G1/01E/SL1C/G1/1546/###/###	1546	7,68
NP/L1C/G1/01E/SL1C/G1/1566/###/###	1566	7,68
NP/L1C/G1/01E/SL1C/G1/1586/###/###	1586	8,16
NP/L1C/G1/01E/SL1C/G1/1626/###/###	1626	8,16
NP/L1C/G1/01E/SL1C/G1/1646/###/###	1646	8,16
NP/L1C/G1/01E/SL1C/G1/1666/###/###	1666	8,16
NP/L1C/G1/01E/SL1C/G1/1686/###/###	1686	8,64
NP/L1C/G1/01E/SL1C/G1/1726/###/###	1726	8,64
NP/L1C/G1/01E/SL1C/G1/1746/###/###	1746	8,64
NP/L1C/G1/01E/SL1C/G1/1765/###/###	1765	8,64
NP/L1C/G1/01E/SL1C/G1/1785/###/###	1785	9,12
NP/L1C/G1/01E/SL1C/G1/1825/###/###	1825	9,12
NP/L1C/G1/01E/SL1C/G1/1845/###/###	1845	9,12
NP/L1C/G1/01E/SL1C/G1/1865/###/###	1865	9,12
NP/L1C/G1/01E/SL1C/G1/1885/###/###	1885	9,60
NP/L1C/G1/01E/SL1C/G1/1925/###/###	1925	9,60
NP/L1C/G1/01E/SL1C/G1/1945/###/###	1945	9,60
NP/L1C/G1/01E/SL1C/G1/1965/###/###	1965	9,60
NP/L1C/G1/01E/SL1C/G1/1985/###/###	1985	10,08

⚠ Achtung! Im Außenbereich (IP65 und IP65 Premium) ist maximal ein Leuchteneinsatz in der Länge von 112 mm bis 1008 mm realisierbar.
Attention! In outdoor areas (IP65 and IP65 Premium), a maximum of one luminaire insert can be realised in lengths from 112 mm to 1008 mm.

**Leistungsangaben +/- 10% | performance data +/- 10%

covers & lenses	T	F	W	G	M
cover round 120° 	620 lm/m 	596 lm/m 	272 lm/m 		
cover square 120° 	598 lm/m 	552 lm/m 	320 lm/m 	224 lm/m 	500 lm/m 
cover flat 120° 	580 lm/m 	530 lm/m 	296 lm/m 		
lens 90° 	610 lm/m 	584 lm/m 			
lens 60° 	610 lm/m 	582 lm/m 			
lens 30° 	584 lm/m 	552 lm/m 			
lens 15° 		564 lm/m 			
lens LAF-2 asymmetric 		554 lm/m 			
lens ILAF asymmetric (IP65 P) 	356 lm/m 				
<p>Alle Werte in der Tabelle gemessen bei 2700 K. Messwerte unterliegen den typischen Toleranzen. Andere Konfigurationen erhalten Sie auf Anfrage. All values in the table measured at 2700 K. Measured values are subject to the typical tolerances. Other configurations are available on request.</p> <p>Alle lichttechnischen Daten – vermessen im FLASHAAR® Lichtlabor – finden Sie unter flashaar.de im Download-Bereich. All photometric data – measured in FLASHAAR's light laboratory – find you at flashaar.de in the download area.</p> <p>Alle optischen und elektrischen Daten haben eine Toleranz von +/- 10%. All optical and electrical data have a tolerance of +/- 10%.</p> <p>Messdaten für IP65 / IP65 Premium auf Anfrage. Measurement data for IP65 / IP65 Premium on request.</p>					<p>EPREL-Daten: 2200 K </p> <p>2700 K </p> <p>3000 K </p> <p>4000 K </p> <p>6500 K </p>

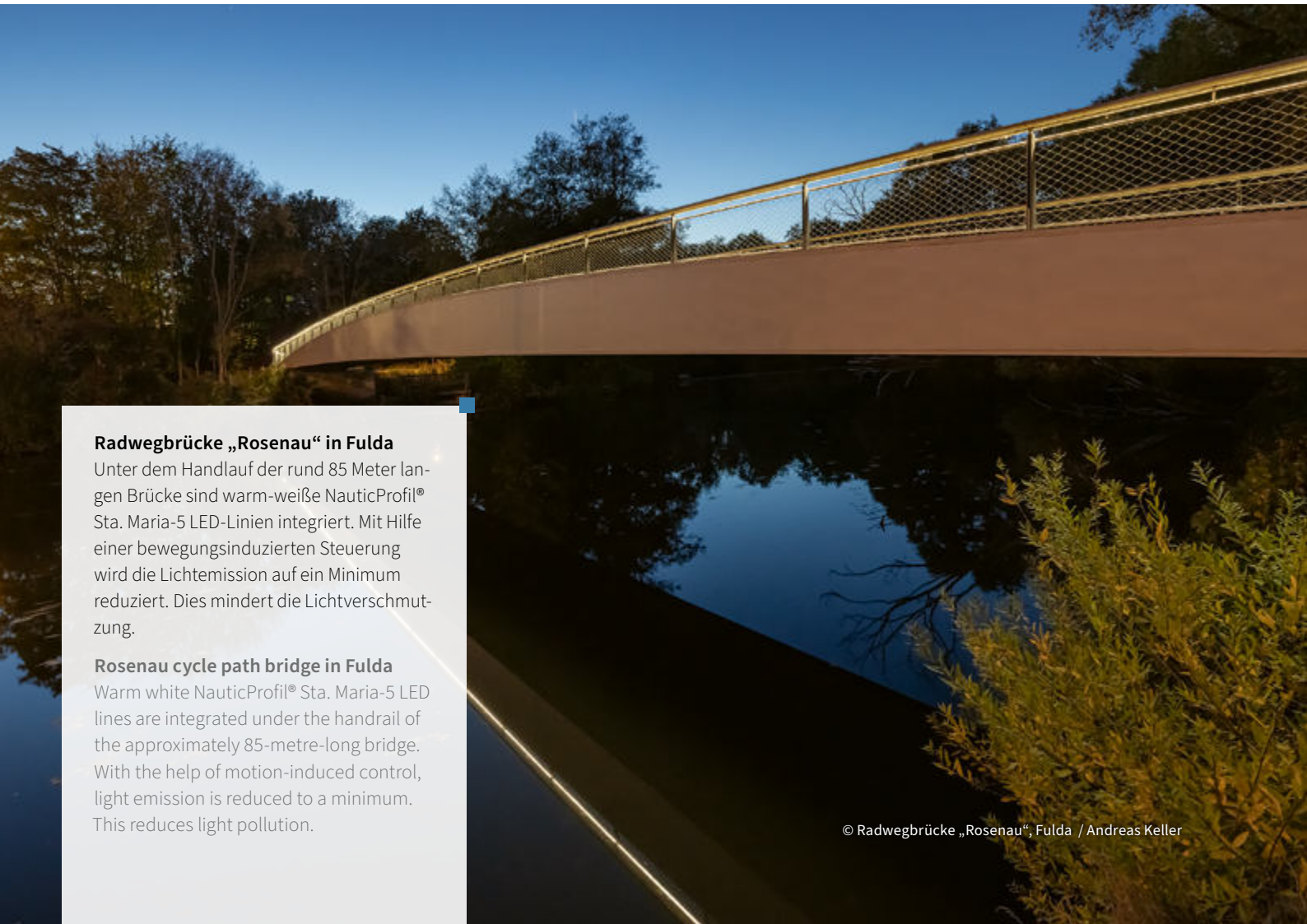
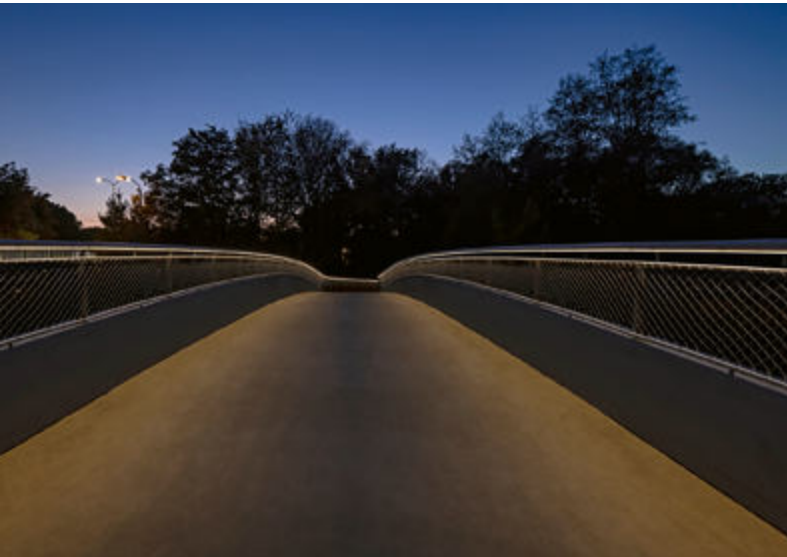

Radwegbrücke „Rosenau“ in Fulda

Unter dem Handlauf der rund 85 Meter langen Brücke sind warm-weiße NauticProfil® Sta. Maria-5 LED-Linien integriert. Mit Hilfe einer bewegungsinduzierten Steuerung wird die Lichtemission auf ein Minimum reduziert. Dies mindert die Lichtverschmutzung.

Rosenau cycle path bridge in Fulda

Warm white NauticProfil® Sta. Maria-5 LED lines are integrated under the handrail of the approximately 85-metre-long bridge. With the help of motion-induced control, light emission is reduced to a minimum. This reduces light pollution.

Verdrahtungsschemata wiring diagrams

Beispiel für max. Länge mit einer elektrischen Einspeisung.*
example for max. length with one electrical feed.*

WD/D/PWM/1a (1x1CH)

Dimmbar mittels PWM, System mit 1 Kanal, 48VDC /
1CH Leuchteneinsätze mit redundanter PIN-Belegung
dimnable by PWM, system with 1 channel, 48VDC /
1CH light insert with double PIN connection
max. **70 m** (365 W) pro Einspeisung / max. 70 m (365 W) per feed in

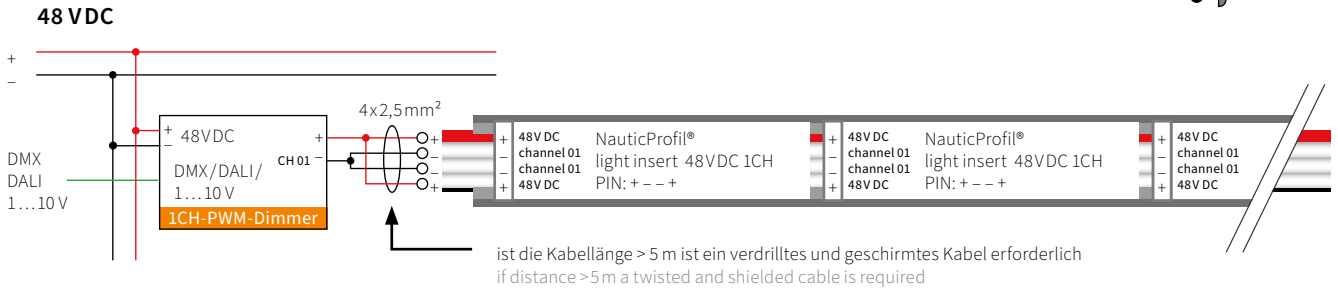
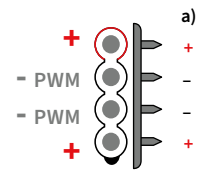

WD/D/PWM/2bb (2x1CH)

Dimmbar mittels PWM, System mit 2 Dimmern 1CH, 48 VDC / 1CH
Leuchteneinsätze
dimnable by PWM, system with 2 dimmer 1CH, 48 VDC / 1CH light insert
max. **100 m** (530 W) pro Einspeisung / max. 100 m (530 W) per feed in

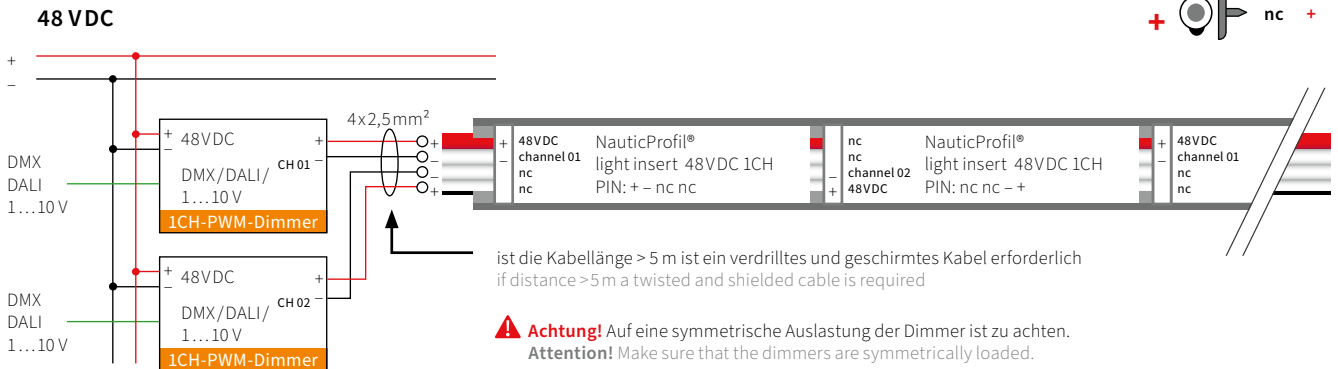
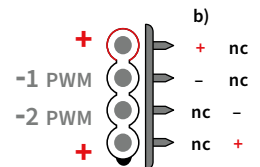

WD/S/1a (1x1CH)

Schaltbar, System mit 1 Kanal /
1CH Leuchteneinsätze mit redundanter PIN-Belegung
to switch ON/OFF, system with 1-channel /
1CH light insert with double PIN connection
max. **100 m** (530 W) pro Einspeisung / max. 100 m (530 W) per feed in

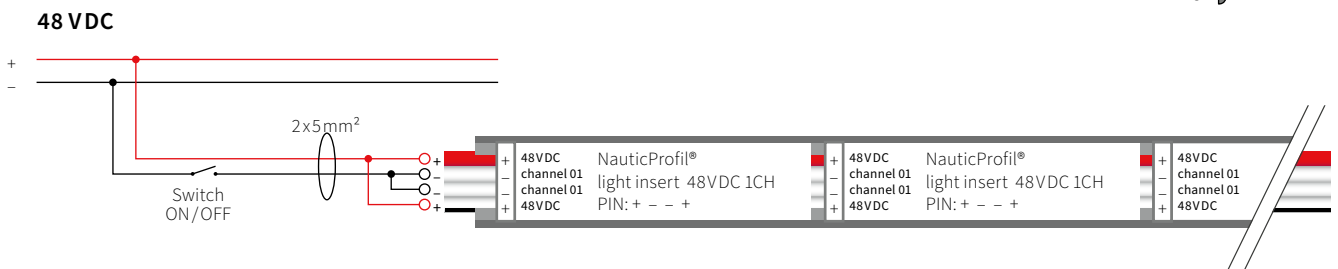
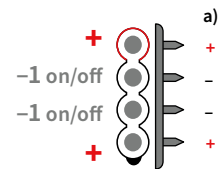

* Standard PIN-Belegung ist + - - + (WD/D/PWM/1a) / Weitere Verdrahtungsschemata in unserem aktuellen Katalog.
standard pin layout is + - - + (WD/D/PWM/1a) / further cabling scheme in our current catalogue.

NP Victory-7



70 m per feed-in | 1282 lm/m* | CRI > 90 | 2200 K - 6500 K

Raum- und Akzentlicht mit
hervorragender Farbwiedergabe
Room and accent lighting with
excellent colour rendering

Unser **NauticProfil® Victory-7** erfüllt den gehobenen Anspruch an absolut homogene Ausleuchtungen von Lichtvouten im Nahbereich. Als LED-Wallwaser sorgt es innen wie außen für eine beeindruckende und harmonische Fassadenbeleuchtung. Über 150 Lichtpunkte je Meter garantieren eine völlig gleichmäßige Lichtlinie ohne sichtbare Lichtpunkte. Der hohe Farbwiedergabeindex mit einem CRI > 90, in Kombination mit der sehr hohen Effizienz, ermöglicht beeindruckende Lichtbilder, insbesondere auch in Verbindung mit unseren Linearlinsen. Es stehen fünf Farbtemperaturen zur Auswahl.

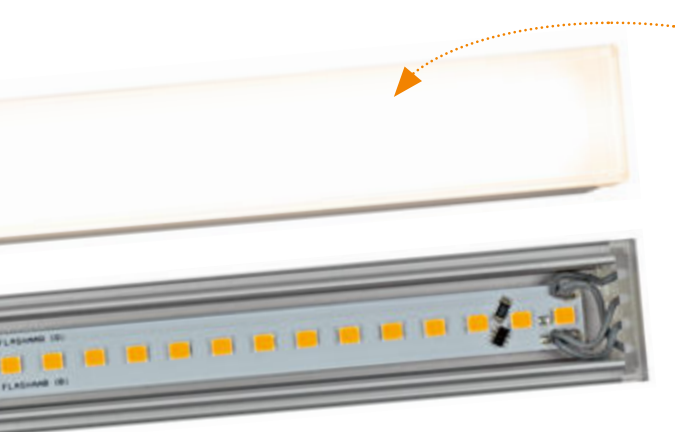

perfekt homogenes Licht
für Voutenbeleuchtung
und Wallwaser-Effekte

perfectly homogeneous
light for cove lighting
and wallwasher effects

The **NauticProfil® Victory-7** meets the high demands for absolutely homogeneous illumination of light coves at close range. As an LED wallwasher, it provides impressive and harmonious facade lighting both indoors and outdoors. Over 150 light points per metre guarantee a completely uniform light line without visible light points. The high colour rendering index with a CRI > 90 in combination with the very high efficiency, enables impressive light images, especially also in combination with our linear lenses. There is a choice of five colour temperatures.

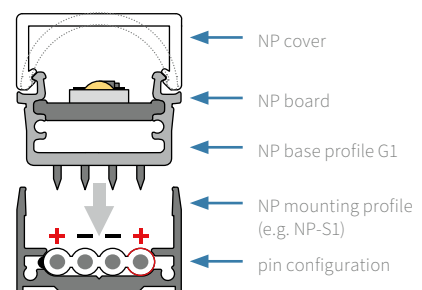
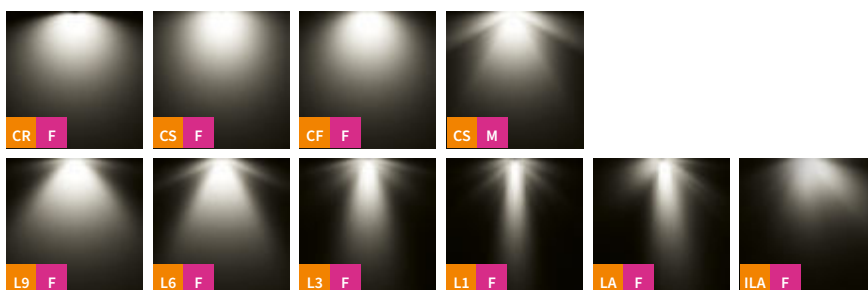

48V DC | 300g | IP40

characteristics

PWM dimmable

dimming

IP65 | IP65 PREMIUM | IK10 | RAL optional

optional

mounting

* Alle Angaben zum Lumenstrom beziehen sich auf das Leuchtmittel. In Kombination mit Cover/Linsen kommt es zu materialbedingtem Lichtverlust.
All information about the luminous flux refers to the light source. In combination with covers/lenses it comes to material-related light loss.

Bestellnummer
item number

NP/L1C/G1/03F / L1C/G1/ 112 / G1/ ALA / 9 27 / CR W

Technische Daten
technical data

nominal voltage: 48VDC (Range: 44,25 to 49,5VDC)
 nominal wattage: 9,6W/m
 photometric code: 9XX/339; CRI > 90
 luminous efficiency [typ]: 134 lm/W
 LED service life: L90/B10 > 100000 h
 dimmable: pulse width modulation (PWM)
 length dividing matrix: 100 mm
 LED pitch: 6,64 mm, 150 LEDs/m
 max. length per feed-in: L(max) DIMMED = 70 m (730 W)*
 2 x 16A PWM dimmer, cabling scheme D/PWM/2bb
 L(max) NOT DIMMED = 70 m (730 W)*,
 according to cabling scheme S/1

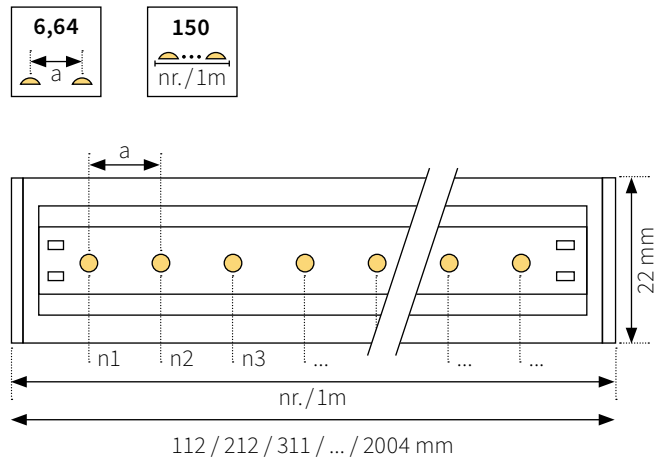

⚠ Achtung! Die Leistung [W] gesamt im NP System ist gleichmäßig auf die Kanäle 1+2 aufzuteilen.
Attention! The total power [W] in the NP system is to be divided equally between channels 1+2.

⚠ Alle optischen und elektrischen Daten haben eine Toleranz von +/- 10%.
 All optical and electrical data have a tolerance of +/- 10%.

Basisprofil
base profile

Das **Basisprofil G1** ist mit allen NP Montageprofilen von FLASHAAR® per Plug&Play kombinierbar. Es ist in den Farben Aluminium (ALA) und Schwarz (BA) eloxiert erhältlich.
 The **base profile G1** can be combined with all NP mounting profiles from FLASHAAR® by Plug & Play. It is available in the colours aluminium (ALA) and black (BA) anodised.

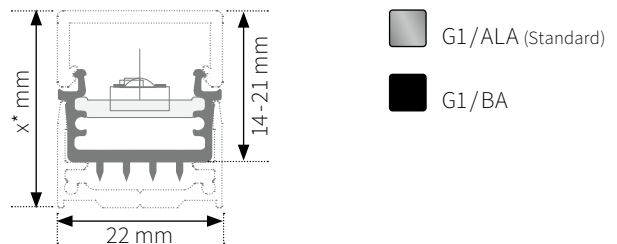

* Leuchtenhöhe abhängig vom Montageprofil (21-168 mm), Maße ab S. 8
 luminaire height depending on mounting profile (21-168 mm), dimensions from p. 8

Farbtemperatur und Lumenstrom
colour temperature and luminous flux

	WW 2200 K**	WW 2700 K	WW 3000 K	NW 4000 K	DL 6500 K**
Farbtemperatur colour temperature	WW 2200 K**	WW 2700 K	WW 3000 K	NW 4000 K	DL 6500 K**
CRI typ.	92	94	93	92	91
Lumenstrom typ. luminous flux* typ.	852 lm/m	1282 lm/m	1324 lm/m	1420 lm/m	1476 lm/m
	922	927	930	940	965

* Alle Angaben zum Lumenstrom beziehen sich auf das Leuchtmittel. In Kombination mit Cover/Linsen kommt es zu materialbedingtem Lichtverlust.
 All information about the luminous flux refers to the light source. In combination with covers/lenses it comes to material-related light loss.

**Farbtemperatur auf Anfrage.
 Colour temperature on request.

Übersicht Standardlängen & Wattagen overview standard lengths & wattages

IP40, IP65, IP65 Premium		
product-nr.	L (mm)*	Watt**
NP/L1C/G1/03F/L1C/G1/0112/###/###	112	0,96
NP/L1C/G1/03F/L1C/G1/0212/###/###	212	1,92
NP/L1C/G1/03F/L1C/G1/0311/###/###	311	2,88
NP/L1C/G1/03F/L1C/G1/0411/###/###	411	3,84
NP/L1C/G1/03F/L1C/G1/0510/###/###	510	4,80
NP/L1C/G1/03F/L1C/G1/0610/###/###	610	5,76
NP/L1C/G1/03F/L1C/G1/0710/###/###	710	6,72
NP/L1C/G1/03F/L1C/G1/0809/###/###	809	7,68
NP/L1C/G1/03F/L1C/G1/0909/###/###	909	8,64
NP/L1C/G1/03F/L1C/G1/1008/###/###	1008	9,60

IP40		
product-nr.	L (mm)*	Watt**
NP/L1C/G1/03F/L1C/G1/1108/###/###	1108	10,56
NP/L1C/G1/03F/L1C/G1/1208/###/###	1208	11,52
NP/L1C/G1/03F/L1C/G1/1307/###/###	1307	12,48
NP/L1C/G1/03F/L1C/G1/1407/###/###	1407	13,44
NP/L1C/G1/03F/L1C/G1/1506/###/###	1506	14,40
NP/L1C/G1/03F/L1C/G1/1606/###/###	1606	15,36
NP/L1C/G1/03F/L1C/G1/1706/###/###	1706	16,32
NP/L1C/G1/03F/L1C/G1/1805/###/###	1805	17,28
NP/L1C/G1/03F/L1C/G1/1905/###/###	1905	18,24
NP/L1C/G1/03F/L1C/G1/2004/###/###	2004	19,20











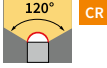



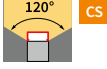





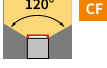



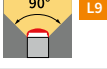









Übersicht der möglichen Sonderlängen & Wattagen (nach Rücksprache) overview of possible special lengths & wattages (after consultation)

IP40, IP65, IP65 Premium		
product-nr.	L (mm)*	Watt**
NP/L1C/G1/03F/SL1C/G1/0132/###/###	132	1,92
NP/L1C/G1/03F/SL1C/G1/0152/###/###	152	1,92
NP/L1C/G1/03F/SL1C/G1/0172/###/###	172	1,92
NP/L1C/G1/03F/SL1C/G1/0192/###/###	192	2,88
NP/L1C/G1/03F/SL1C/G1/0232/###/###	232	2,88
NP/L1C/G1/03F/SL1C/G1/0252/###/###	252	2,88
NP/L1C/G1/03F/SL1C/G1/0271/###/###	271	2,88
NP/L1C/G1/01E/SL1C/G1/0291/###/###	291	3,84
NP/L1C/G1/03F/SL1C/G1/0331/###/###	331	3,84
NP/L1C/G1/03F/SL1C/G1/0351/###/###	351	3,84
NP/L1C/G1/03F/SL1C/G1/0371/###/###	371	3,84
NP/L1C/G1/03F/SL1C/G1/0391/###/###	391	4,80
NP/L1C/G1/03F/SL1C/G1/0431/###/###	431	4,80
NP/L1C/G1/03F/SL1C/G1/0451/###/###	451	4,80
NP/L1C/G1/03F/SL1C/G1/0471/###/###	471	4,80
NP/L1C/G1/03F/SL1C/G1/0491/###/###	491	5,76
NP/L1C/G1/03F/SL1C/G1/0530/###/###	530	5,76
NP/L1C/G1/03F/SL1C/G1/0550/###/###	550	5,76
NP/L1C/G1/03F/SL1C/G1/0570/###/###	570	5,76
NP/L1C/G1/03F/SL1C/G1/0590/###/###	590	6,72
NP/L1C/G1/03F/SL1C/G1/0630/###/###	630	6,72
NP/L1C/G1/03F/SL1C/G1/0650/###/###	650	6,72
NP/L1C/G1/03F/SL1C/G1/0670/###/###	670	6,72
NP/L1C/G1/03F/SL1C/G1/0690/###/###	690	7,68
NP/L1C/G1/03F/SL1C/G1/0730/###/###	730	7,68
NP/L1C/G1/03F/SL1C/G1/0750/###/###	750	7,68
NP/L1C/G1/03F/SL1C/G1/0769/###/###	769	7,68
NP/L1C/G1/03F/SL1C/G1/0789/###/###	789	8,64
NP/L1C/G1/03F/SL1C/G1/0829/###/###	829	8,64
NP/L1C/G1/03F/SL1C/G1/0849/###/###	849	8,64
NP/L1C/G1/03F/SL1C/G1/0869/###/###	869	8,64
NP/L1C/G1/03F/SL1C/G1/0889/###/###	889	9,60
NP/L1C/G1/03F/SL1C/G1/0929/###/###	929	9,60
NP/L1C/G1/03F/SL1C/G1/0949/###/###	949	9,60
NP/L1C/G1/03F/SL1C/G1/0969/###/###	969	9,60
NP/L1C/G1/03F/SL1C/G1/0989/###/###	989	10,56

IP40		
product-nr.	L (mm)*	Watt**
NP/L1C/G1/03F/SL1C/G1/1028/###/###	1028	10,56
NP/L1C/G1/03F/SL1C/G1/1048/###/###	1048	10,56
NP/L1C/G1/03F/SL1C/G1/1068/###/###	1068	10,56
NP/L1C/G1/03F/SL1C/G1/1088/###/###	1088	11,52
NP/L1C/G1/03F/SL1C/G1/1128/###/###	1128	11,52
NP/L1C/G1/03F/SL1C/G1/1148/###/###	1148	11,52
NP/L1C/G1/03F/SL1C/G1/1168/###/###	1168	11,52
NP/L1C/G1/03F/SL1C/G1/1188/###/###	1188	12,48
NP/L1C/G1/03F/SL1C/G1/1228/###/###	1228	12,48
NP/L1C/G1/03F/SL1C/G1/1248/###/###	1248	12,48
NP/L1C/G1/03F/SL1C/G1/1267/###/###	1267	12,48
NP/L1C/G1/03F/SL1C/G1/1287/###/###	1287	13,44
NP/L1C/G1/03F/SL1C/G1/1327/###/###	1327	13,44
NP/L1C/G1/03F/SL1C/G1/1347/###/###	1347	13,44
NP/L1C/G1/03F/SL1C/G1/1367/###/###	1367	13,44
NP/L1C/G1/03F/SL1C/G1/1387/###/###	1387	14,40
NP/L1C/G1/03F/SL1C/G1/1427/###/###	1427	14,40
NP/L1C/G1/03F/SL1C/G1/1447/###/###	1447	14,40
NP/L1C/G1/03F/SL1C/G1/1467/###/###	1467	14,40
NP/L1C/G1/03F/SL1C/G1/1487/###/###	1487	15,36
NP/L1C/G1/03F/SL1C/G1/1526/###/###	1526	15,36
NP/L1C/G1/03F/SL1C/G1/1546/###/###	1546	15,36
NP/L1C/G1/03F/SL1C/G1/1566/###/###	1566	15,36
NP/L1C/G1/03F/SL1C/G1/1586/###/###	1586	16,32
NP/L1C/G1/03F/SL1C/G1/1626/###/###	1626	16,32
NP/L1C/G1/03F/SL1C/G1/1646/###/###	1646	16,32
NP/L1C/G1/03F/SL1C/G1/1666/###/###	1666	16,32
NP/L1C/G1/03F/SL1C/G1/1686/###/###	1686	17,28
NP/L1C/G1/03F/SL1C/G1/1726/###/###	1726	17,28
NP/L1C/G1/03F/SL1C/G1/1746/###/###	1746	17,28
NP/L1C/G1/03F/SL1C/G1/1765/###/###	1765	17,28
NP/L1C/G1/03F/SL1C/G1/1785/###/###	1785	18,24
NP/L1C/G1/03F/SL1C/G1/1825/###/###	1825	18,24
NP/L1C/G1/03F/SL1C/G1/1845/###/###	1845	18,24
NP/L1C/G1/03F/SL1C/G1/1865/###/###	1865	18,24
NP/L1C/G1/03F/SL1C/G1/1885/###/###	1885	19,20
NP/L1C/G1/03F/SL1C/G1/1925/###/###	1925	19,20
NP/L1C/G1/03F/SL1C/G1/1945/###/###	1945	19,20
NP/L1C/G1/03F/SL1C/G1/1965/###/###	1965	19,20
NP/L1C/G1/03F/SL1C/G1/1985/###/###	1985	20,16

⚠ Achtung! Im Außenbereich (IP65 und IP65 Premium) ist maximal ein Leuchteneinsatz in der Länge von 112 mm bis 1008 mm realisierbar.
Attention! In outdoor areas (IP65 and IP65 Premium), a maximum of one luminaire insert can be realised in lengths from 112 mm to 1008 mm.

**Leistungsangaben +/- 10% | performance data +/- 10%

covers & lenses	T	F	W	G	M
cover round 120° 	1212 lm/m 	832 lm/m 	486 lm/m 		
cover square 120° 	1174 lm/m 	1040 lm/m 	574 lm/m 	434 lm/m 	946 lm/m 
cover flat 120° 	1132 lm/m 	1020 lm/m 	568 lm/m 		
lens 90° 	1186 lm/m 	1138 lm/m 			
lens 60° 	1204 lm/m 	1128 lm/m 			
lens 30° 	1128 lm/m 	1078 lm/m 			
lens 15° 		1072 lm/m 			
lens LAF-2 asymmetric 		1084 lm/m 			
lens ILAF asymmetric (IP65 P) 	676 lm/m 				
<p>Alle Werte in der Tabelle gemessen bei 2700 K. Messwerte unterliegen den typischen Toleranzen. Andere Konfigurationen erhalten Sie auf Anfrage. All values in the table measured at 2700 K. Measured values are subject to the typical tolerances. Other configurations are available on request. Alle lichttechnischen Daten – vermessen im FLASHAAR® Lichtlabor – finden Sie unter flashaar.de im Download-Bereich. Alle optischen und elektrischen Daten haben eine Toleranz von +/- 10%. All photometric data – measured in FLASHAAR's light laboratory – available at flashaar.de/en in the download area. All optical and electrical data have a tolerance of +/- 10%.</p> <p>Messdaten für IP65 / IP65 Premium auf Anfrage. Measurement data for IP65 / IP65 Premium on request.</p>					<p>EPREL-Daten: 2200 K  2700 K  3000 K  4000 K  6500 K </p>



Der Hörraum

Die mit Lichtlinien von FLASHAAR® hinterleuchteten Textilwände im sogenannten „Hörraum“, schaffen einen sanften Hintergrund, während die Besucher den Klang zahlreicher Kulturen mit den Ohren erfahren können.

the listening room

In the so-called „listening room“, textile walls backlit with FLASHAAR® light lines create a soft background while visitors can experience the sound of numerous cultures with their ears.

Verdrahtungsschemata wiring diagrams

Beispiel für max. Länge mit einer elektrischen Einspeisung.*
example for max. length with one electrical feed.*

WD/D/PWM/1a (1x1CH)

Dimmbar mittels PWM, System mit 1 Kanal, 48VDC /
1CH Leuchteneinsätze mit redundanter PIN-Belegung
dimnable by PWM, System with 1 channel, 48VDC /
1CH light insert with double PIN connection
max. **47 m** (500 W) pro Einspeisung / max. 47 m (500 W) per feed in

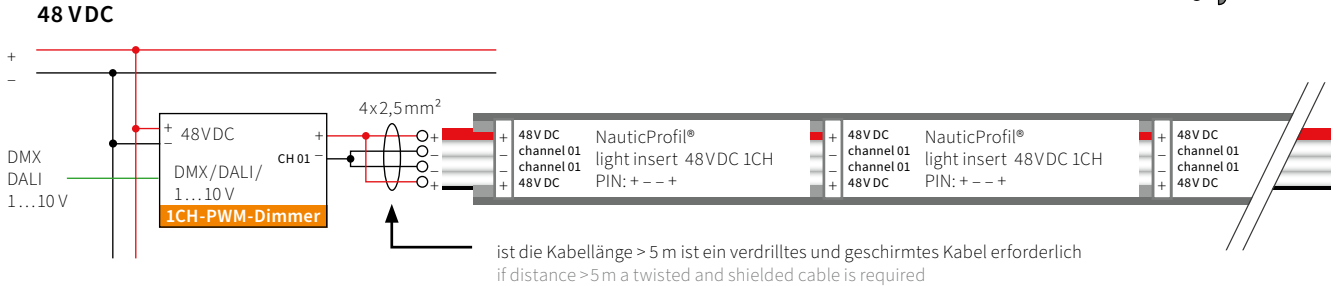
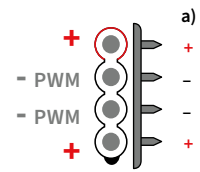

WD/D/PWM/2bb (2x1CH)

Dimmbar mittels PWM, System mit 2 Dimmern 1CH, 48 VDC / 1CH
Leuchteneinsätze
dimnable by PWM, system with 2 dimmer 1CH, 48 VDC / 1CH light insert
max. **70 m** (730 W) pro Einspeisung / max. 70 m (730 W) per feed in

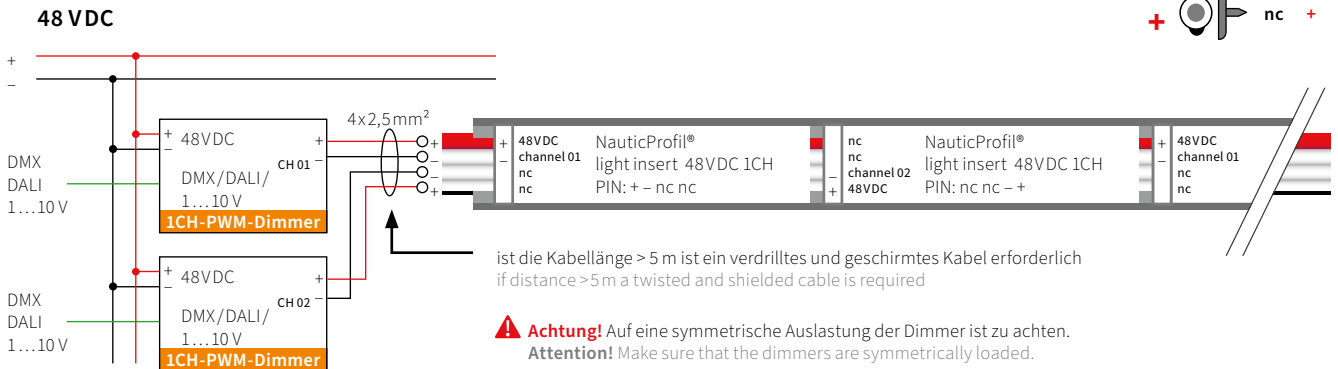
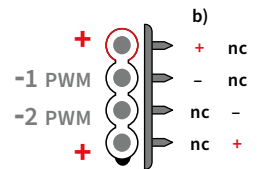

WD/S/1a (1x1CH)

Schaltbar, System mit 1 Kanal /
1CH Leuchteneinsätze mit redundanter PIN-Belegung
to switch ON/OFF, system with 1-channel /
1CH light insert with double PIN connection
max. **72 m** (750 W) pro Einspeisung / max. 72 m (750 W) per feed in

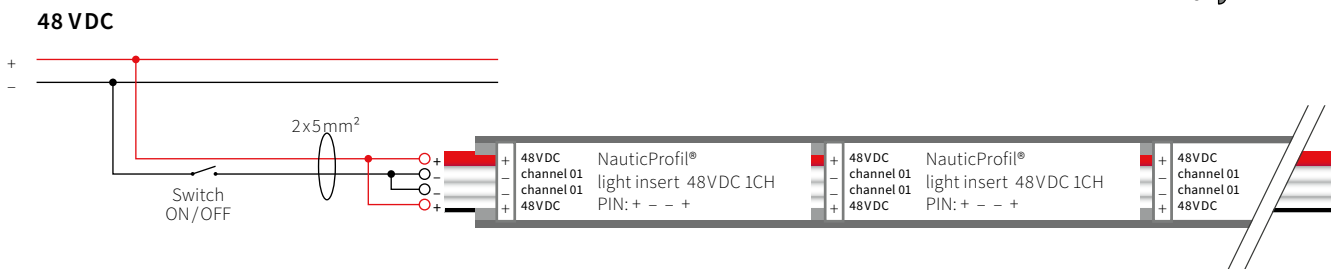
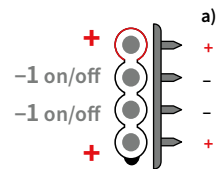

* Standard PIN-Belegung ist + - - + (WD/D/PWM/1a) / Weitere Verdrahtungsschemata in unserem aktuellen Katalog.
standard pin layout is + - - + (WD/D/PWM/1a) / further cabling scheme in our current catalogue.

NP Navigator-3



70m per feed-in | 1576 lm/m* | CRI > 80 | 2200 K-6500 K

Erste Wahl für universelle und wirtschaftliche Beleuchtungskonzepte
First choice for universal and economical lighting concepts

Die hohe Effizienz von 164 lm/W machen unser **NauticProfil® Navigator-3** zur ersten Wahl für wirtschaftliche Allgemeinbeleuchtungen. Durch seine lange Lebensdauer lassen sich nahezu wartungsfreie Lichtlösungen verwirklichen. Unser NauticProfil® Navigator-3 ermöglicht sowohl in Wohn- und Geschäftsbereichen, als auch im öffentlichen Raum ein breites Spektrum an anspruchsvollen Beleuchtungsmöglichkeiten. Rund 1600 lm/m Lichtstrom sorgen für ausreichende Helligkeit. Es stehen fünf Farbtemperaturen zur Auswahl.

Its high efficiency of 164 lm/W makes our **NauticProfil® Navigator-3** the first choice for economical general lighting. Due to their long service life, almost maintenance-free lighting solutions can be realised. Our NauticProfil® Navigator-3 enables a wide range of sophisticated lighting options in residential and commercial areas as well as in public spaces. Around 1600 lm/m luminous flux provides sufficient brightness. There is a choice of five colour temperatures.

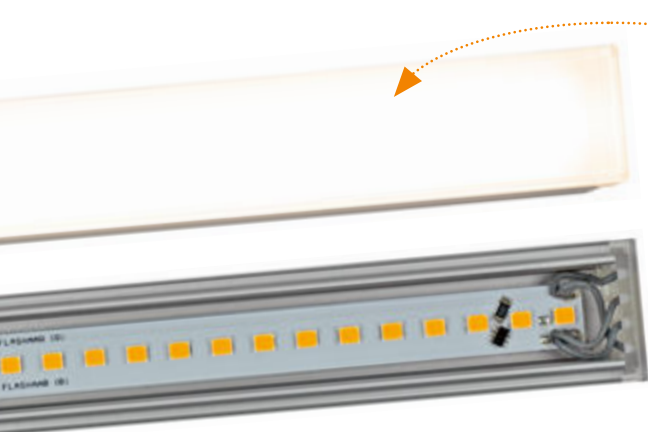

effizientes Licht für allgemeine Innen- und Außenbeleuchtung

efficient light for general indoor and outdoor lighting

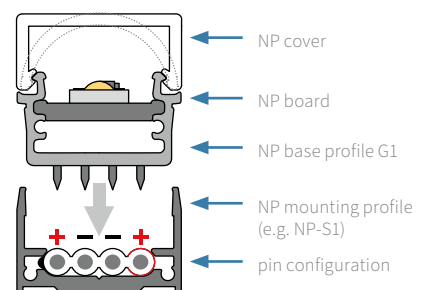
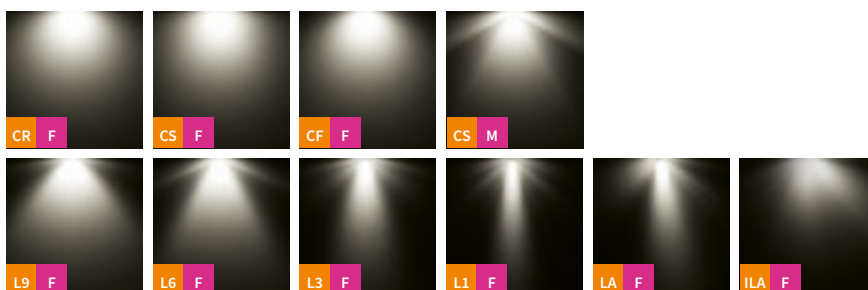

characteristics



dimming



optional



mounting



* Alle Angaben zum Lumenstrom beziehen sich auf das Leuchtmittel. In Kombination mit Cover/Linsen kommt es zu materialbedingtem Lichtverlust.
All information about the luminous flux refers to the light source. In combination with covers/lenses it comes to material-related light loss.

Bestellnummer
item number

NP/L1C/G1/14C / L1C/G1/ 112 / G1/ ALA / 8 27 / CR W

Technische Daten
technical data

nominal voltage: 48VDC (Range: 44,25 to 49,5VDC)
 nominal wattage: 9,6W/m
 photometric code: 8XX/339; CRI > 80
 luminous efficiency [typ]: 164 lm/W
 LED service life: L90/B10 > 100000h
 dimmable: pulse width modulation (PWM)
 length dividing matrix: 100mm
 LED pitch: 6,64mm, 150 LEDs/m
 max. length per feed-in: L(max) DIMMED = 70m (730W)*
 2 x 16A PWM dimmer, cabling scheme D/PWM/2bb
 L(max) NOT DIMMED = 70m (730 W)*,
 according to cabling scheme S/1

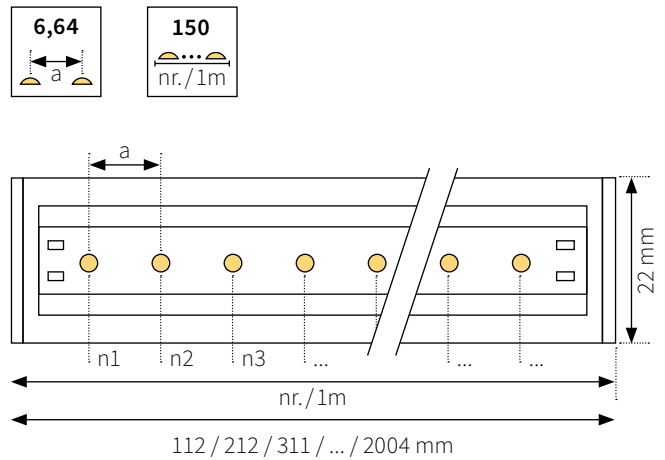

⚠ Achtung! Die Leistung [W] gesamt im NP System ist gleichmäßig auf die Kanäle 1+2 aufzuteilen.
Attention! The total power [W] in the NP system is to be divided equally between channels 1+2.

⚠ Alle optischen und elektrischen Daten haben eine Toleranz von +/- 10%.
 All optical and electrical data have a tolerance of +/- 10%.

Basisprofil
base profile

Das **Basisprofil G1** ist mit allen NP Montageprofilen von FLASHAAR® per Plug&Play kombinierbar. Es ist in den Farben Aluminium (ALA) und Schwarz (BA) eloxiert erhältlich.
 The **base profile G1** can be combined with all NP mounting profiles from FLASHAAR® by Plug & Play. It is available in the colours aluminium (ALA) and black (BA) anodised.

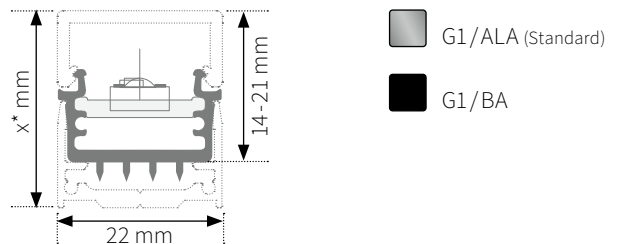

* Leuchtenhöhe abhängig vom Montageprofil (21-168 mm), Maße ab S. 8
 luminaire height depending on mounting profile (21-168 mm), dimensions from p. 8

Farbtemperatur und Lumenstrom
colour temperature and luminous flux

	WW 2200 K**	WW 2700 K	WW 3000 K	NW 4000 K	DL 6500 K**
Farbtemperatur colour temperature	WW 2200 K**	WW 2700 K	WW 3000 K	NW 4000 K	DL 6500 K**
CRI typ.	82	82	83	84	82
Lumenstrom typ. luminous flux* typ.	1326lm/m	1576lm/m	1618lm/m	1704lm/m	1644lm/m
	822	827	830	840	865

* Alle Angaben zum Lumenstrom beziehen sich auf das Leuchtmittel. In Kombination mit Cover/Linsen kommt es zu materialbedingtem Lichtverlust.
 All information about the luminous flux refers to the light source. In combination with covers/lenses it comes to material-related light loss.

**Farbtemperatur auf Anfrage.
 Colour temperature on request.

Übersicht Standardlängen & Wattagen

overview standard lengths & wattages

IP40, IP65, IP65 Premium		
product-nr.	L (mm)*	Watt**
NP/L1C/G1/14C/L1C/G1/0112/###/###	112	0,96
NP/L1C/G1/14C/L1C/G1/0212/###/###	212	1,92
NP/L1C/G1/14C/L1C/G1/0311/###/###	311	2,88
NP/L1C/G1/14C/L1C/G1/0411/###/###	411	3,84
NP/L1C/G1/14C/L1C/G1/0510/###/###	510	4,80
NP/L1C/G1/14C/L1C/G1/0610/###/###	610	5,76
NP/L1C/G1/14C/L1C/G1/0710/###/###	710	6,72
NP/L1C/G1/14C/L1C/G1/0809/###/###	809	7,68
NP/L1C/G1/14C/L1C/G1/0909/###/###	909	8,64
NP/L1C/G1/14C/L1C/G1/1008/###/###	1008	9,60

IP40		
product-nr.	L (mm)*	Watt**
NP/L1C/G1/14C/L1C/G1/1108/###/###	1108	10,56
NP/L1C/G1/14C/L1C/G1/1208/###/###	1208	11,52
NP/L1C/G1/14C/L1C/G1/1307/###/###	1307	12,48
NP/L1C/G1/14C/L1C/G1/1407/###/###	1407	13,44
NP/L1C/G1/14C/L1C/G1/1506/###/###	1506	14,40
NP/L1C/G1/14C/L1C/G1/1606/###/###	1606	15,36
NP/L1C/G1/14C/L1C/G1/1706/###/###	1706	16,32
NP/L1C/G1/14C/L1C/G1/1805/###/###	1805	17,28
NP/L1C/G1/14C/L1C/G1/1905/###/###	1905	18,24
NP/L1C/G1/14C/L1C/G1/2004/###/###	2004	19,20

Übersicht der möglichen Sonderlängen & Wattagen (nach Rücksprache)











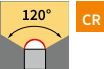
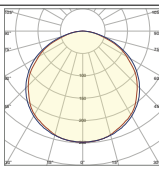
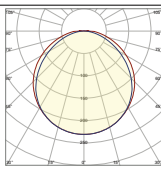
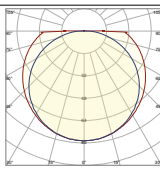
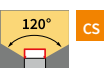
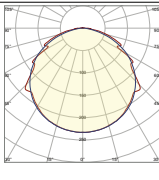
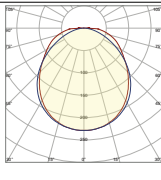
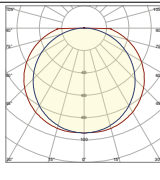
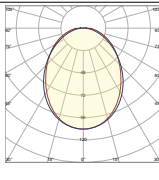
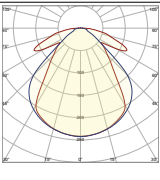

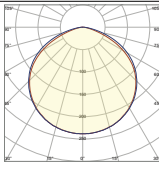
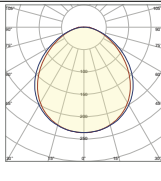
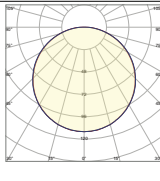
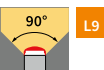
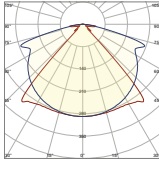
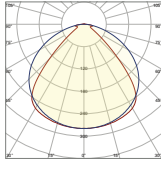

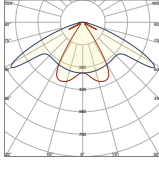
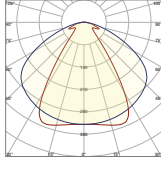

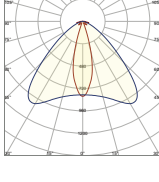
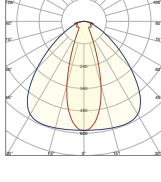
overview of possible special lengths & wattages (after consultation)

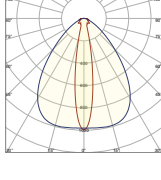
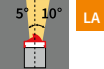
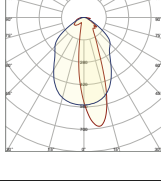
IP40, IP65, IP65 Premium		
product-nr.	L (mm)*	Watt**
NP/L1C/G1/14C/SL1C/G1/0132/###/###	132	1,92
NP/L1C/G1/14C/SL1C/G1/0152/###/###	152	1,92
NP/L1C/G1/14C/SL1C/G1/0171/###/###	172	1,92
NP/L1C/G1/14C/SL1C/G1/0192/###/###	192	2,88
NP/L1C/G1/14C/SL1C/G1/0232/###/###	232	2,88
NP/L1C/G1/14C/SL1C/G1/0252/###/###	252	2,88
NP/L1C/G1/14C/SL1C/G1/0271/###/###	271	2,88
NP/L1C/G1/14C/SL1C/G1/0291/###/###	291	3,84
NP/L1C/G1/14C/SL1C/G1/0331/###/###	331	3,84
NP/L1C/G1/14C/SL1C/G1/0351/###/###	351	3,84
NP/L1C/G1/14C/SL1C/G1/0371/###/###	371	3,84
NP/L1C/G1/14C/SL1C/G1/0391/###/###	391	4,80
NP/L1C/G1/14C/SL1C/G1/0431/###/###	431	4,80
NP/L1C/G1/14C/SL1C/G1/0451/###/###	451	4,80
NP/L1C/G1/14C/SL1C/G1/0471/###/###	471	4,80
NP/L1C/G1/14C/SL1C/G1/0491/###/###	491	5,76
NP/L1C/G1/14C/SL1C/G1/0530/###/###	530	5,76
NP/L1C/G1/14C/SL1C/G1/0550/###/###	550	5,76
NP/L1C/G1/14C/SL1C/G1/0570/###/###	570	5,76
NP/L1C/G1/14C/SL1C/G1/0590/###/###	590	6,72
NP/L1C/G1/14C/SL1C/G1/0630/###/###	630	6,72
NP/L1C/G1/14C/SL1C/G1/0650/###/###	650	6,72
NP/L1C/G1/14C/SL1C/G1/0670/###/###	670	6,72
NP/L1C/G1/14C/SL1C/G1/0690/###/###	690	7,68
NP/L1C/G1/14C/SL1C/G1/0730/###/###	730	7,68
NP/L1C/G1/14C/SL1C/G1/0750/###/###	750	7,68
NP/L1C/G1/14C/SL1C/G1/0769/###/###	769	7,68
NP/L1C/G1/14C/SL1C/G1/0789/###/###	789	8,64
NP/L1C/G1/14C/SL1C/G1/0829/###/###	829	8,64
NP/L1C/G1/14C/SL1C/G1/0849/###/###	849	8,64
NP/L1C/G1/14C/SL1C/G1/0869/###/###	869	8,64
NP/L1C/G1/14C/SL1C/G1/0889/###/###	889	9,60
NP/L1C/G1/14C/SL1C/G1/0929/###/###	929	9,60
NP/L1C/G1/14C/SL1C/G1/0949/###/###	949	9,60
NP/L1C/G1/14C/SL1C/G1/0969/###/###	969	9,60
NP/L1C/G1/14C/SL1C/G1/0989/###/###	989	10,56

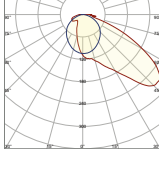
IP40		
product-nr.	L (mm)*	Watt**
NP/L1C/G1/14C/SL1C/G1/1028/###/###	1028	10,56
NP/L1C/G1/14C/SL1C/G1/1048/###/###	1048	10,56
NP/L1C/G1/14C/SL1C/G1/1068/###/###	1068	10,56
NP/L1C/G1/14C/SL1C/G1/1088/###/###	1088	11,52
NP/L1C/G1/14C/SL1C/G1/1128/###/###	1128	11,52
NP/L1C/G1/14C/SL1C/G1/1148/###/###	1148	11,52
NP/L1C/G1/14C/SL1C/G1/1168/###/###	1168	11,52
NP/L1C/G1/14C/SL1C/G1/1188/###/###	1188	12,48
NP/L1C/G1/14C/SL1C/G1/1228/###/###	1228	12,48
NP/L1C/G1/14C/SL1C/G1/1248/###/###	1248	12,48
NP/L1C/G1/14C/SL1C/G1/1267/###/###	1267	12,48
NP/L1C/G1/14C/SL1C/G1/1287/###/###	1287	13,44
NP/L1C/G1/14C/SL1C/G1/1327/###/###	1327	13,44
NP/L1C/G1/14C/SL1C/G1/1347/###/###	1347	13,44
NP/L1C/G1/14C/SL1C/G1/1367/###/###	1367	13,44
NP/L1C/G1/14C/SL1C/G1/1387/###/###	1387	14,40
NP/L1C/G1/14C/SL1C/G1/1427/###/###	1427	14,40
NP/L1C/G1/14C/SL1C/G1/1447/###/###	1447	14,40
NP/L1C/G1/14C/SL1C/G1/1467/###/###	1467	14,40
NP/L1C/G1/14C/SL1C/G1/1487/###/###	1487	15,36
NP/L1C/G1/14C/SL1C/G1/1526/###/###	1526	15,36
NP/L1C/G1/14C/SL1C/G1/1546/###/###	1546	15,36
NP/L1C/G1/14C/SL1C/G1/1566/###/###	1566	15,36
NP/L1C/G1/14C/SL1C/G1/1586/###/###	1586	16,32
NP/L1C/G1/14C/SL1C/G1/1626/###/###	1626	16,32
NP/L1C/G1/14C/SL1C/G1/1646/###/###	1646	16,32
NP/L1C/G1/14C/SL1C/G1/1666/###/###	1666	16,32
NP/L1C/G1/14C/SL1C/G1/1686/###/###	1686	17,28
NP/L1C/G1/14C/SL1C/G1/1726/###/###	1726	17,28
NP/L1C/G1/14C/SL1C/G1/1746/###/###	1746	17,28
NP/L1C/G1/14C/SL1C/G1/1765/###/###	1765	17,28
NP/L1C/G1/14C/SL1C/G1/1785/###/###	1785	18,24
NP/L1C/G1/14C/SL1C/G1/1825/###/###	1825	18,24
NP/L1C/G1/14C/SL1C/G1/1845/###/###	1845	18,24
NP/L1C/G1/14C/SL1C/G1/1865/###/###	1865	18,24
NP/L1C/G1/14C/SL1C/G1/1885/###/###	1885	19,20
NP/L1C/G1/14C/SL1C/G1/1925/###/###	1925	19,20
NP/L1C/G1/14C/SL1C/G1/1945/###/###	1945	19,20
NP/L1C/G1/14C/SL1C/G1/1965/###/###	1965	19,20
NP/L1C/G1/14C/SL1C/G1/1985/###/###	1985	20,16

⚠ Achtung! Im Außenbereich (IP65 und IP65 Premium) ist maximal ein Leuchteneinsatz in der Länge von 112 mm bis 1008 mm realisierbar.
Attention! In outdoor areas (IP65 and IP65 Premium), a maximum of one luminaire insert can be realised in lengths from 112 mm to 1008 mm.

**Leistungsangaben +/- 10% | performance data +/- 10%

covers & lenses	T	F	W	G	M
cover round 120° 	1484 lm/m 	1406 lm/m 	608 lm/m 		
cover square 120° 	1436 lm/m 	1304 lm/m 	708 lm/m 	524 lm/m 	1142 lm/m 
cover flat 120° 	1382 lm/m 	1262 lm/m 	698 lm/m 		
lens 90° 	1442 lm/m 	1396 lm/m 			
lens 60° 	1484 lm/m 	1402 lm/m 			
lens 30° 	1362 lm/m 	1328 lm/m 			
lens 15° 		1330 lm/m 			
lens LAF-2 asymmetric 		1326 lm/m 			
lens ILAF asymmetric (IP65 P) 	802 lm/m 				
<p>Alle Werte in der Tabelle gemessen bei 2700 K. Messwerte unterliegen den typischen Toleranzen. Andere Konfigurationen erhalten Sie auf Anfrage. All values in the table measured at 2700 K. Measured values are subject to the typical tolerances. Other configurations are available on request. Alle lichttechnischen Daten – vermessen im FLASHAAR® Lichtlabor – finden Sie unter flashaar.de im Download-Bereich. Alle optischen und elektrischen Daten haben eine Toleranz von +/- 10%. All photometric data – measured in FLASHAAR's light laboratory – available at flashaar.de/en in the download area. All optical and electrical data have a tolerance of +/- 10%.</p> <p>Messdaten für IP65 / IP65 Premium auf Anfrage. Measurement data for IP65 / IP65 Premium on request.</p>					<p>EPREL-Daten: 2200 K  2700 K  3000 K  4000 K  6500 K </p>

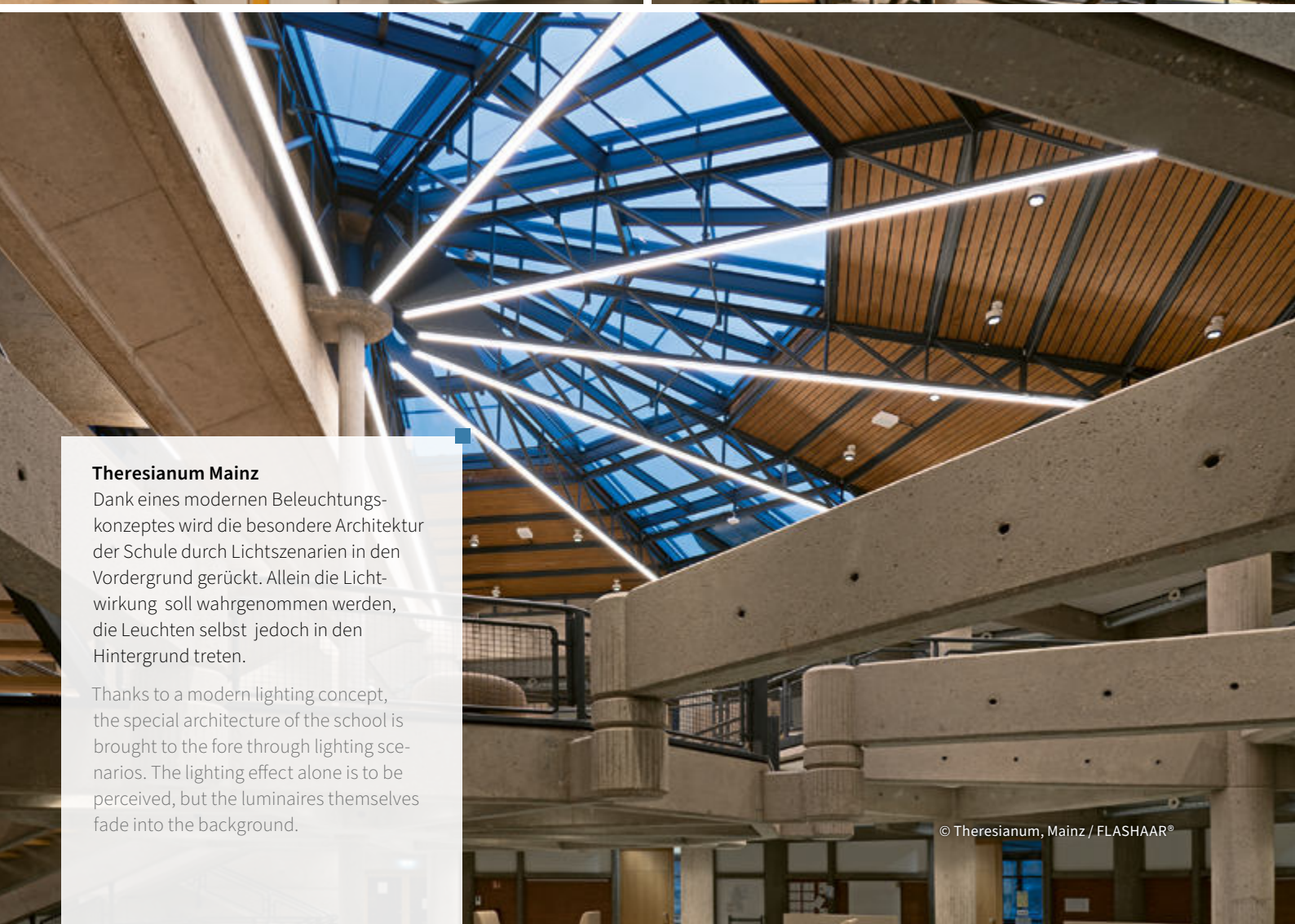

Theresianum Mainz

Dank eines modernen Beleuchtungskonzeptes wird die besondere Architektur der Schule durch Lichtszenarien in den Vordergrund gerückt. Allein die Lichtwirkung soll wahrgenommen werden, die Leuchten selbst jedoch in den Hintergrund treten.

Thanks to a modern lighting concept, the special architecture of the school is brought to the fore through lighting scenarios. The lighting effect alone is to be perceived, but the luminaires themselves fade into the background.

Verdrahtungsschemata wiring diagrams

Beispiel für max. Länge mit einer elektrischen Einspeisung.*
example for max. length with one electrical feed.*

WD/D/PWM/1a (1x1CH)

Dimmbar mittels PWM, System mit 1 Kanal, 48VDC /
1CH Leuchteneinsätze mit redundanter PIN-Belegung
dimnable by PWM, system with 1 channel, 48VDC /
1CH light insert with double PIN connection
max. **47 m** (500 W) pro Einspeisung / max. 47 m (500 W) per feed in

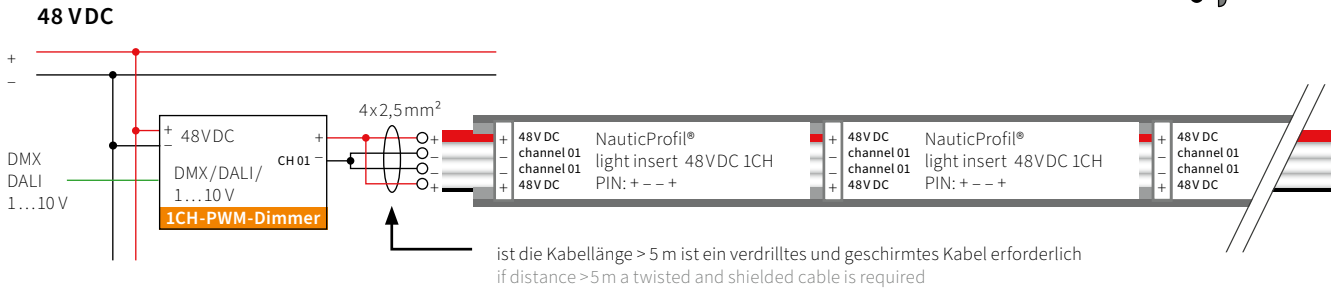
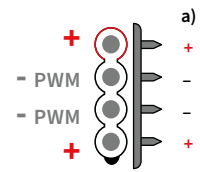

WD/D/PWM/2bb (2x1CH)

Dimmbar mittels PWM, System mit 2 Dimmern 1CH, 48 VDC / 1CH
Leuchteneinsätze
dimnable by PWM, system with 2 dimmer 1CH, 48 VDC / 1CH light insert
max. **70 m** (730 W) pro Einspeisung / max. 70 m (730 W) per feed in

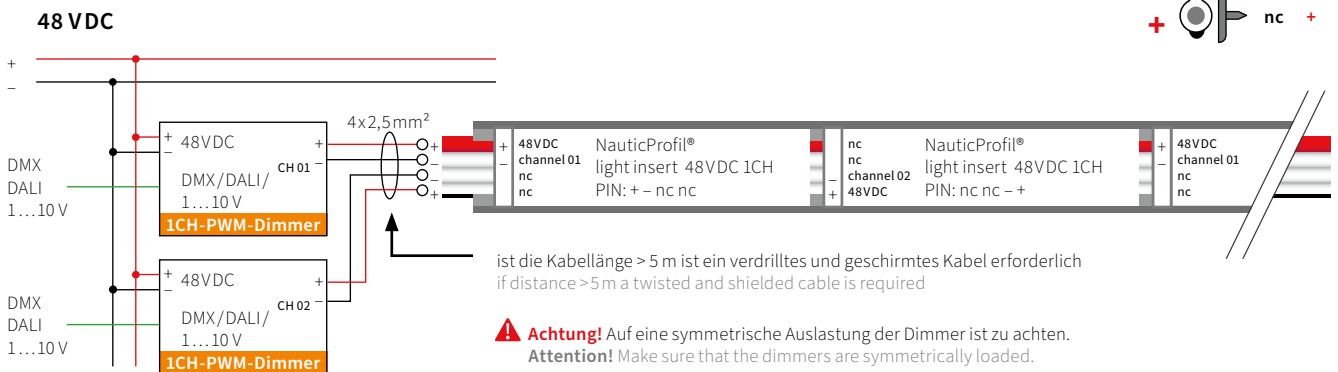
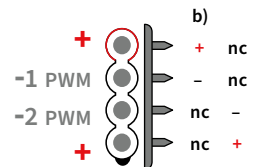

WD/S/1a (1x1CH)

Schaltbar, System mit 1 Kanal /
1CH Leuchteneinsätze mit redundanter PIN-Belegung
to switch ON/OFF, system with 1-channel /
1CH light insert with double PIN connection
max. **72 m** (750 W) pro Einspeisung / max. 72 m (750 W) per feed in

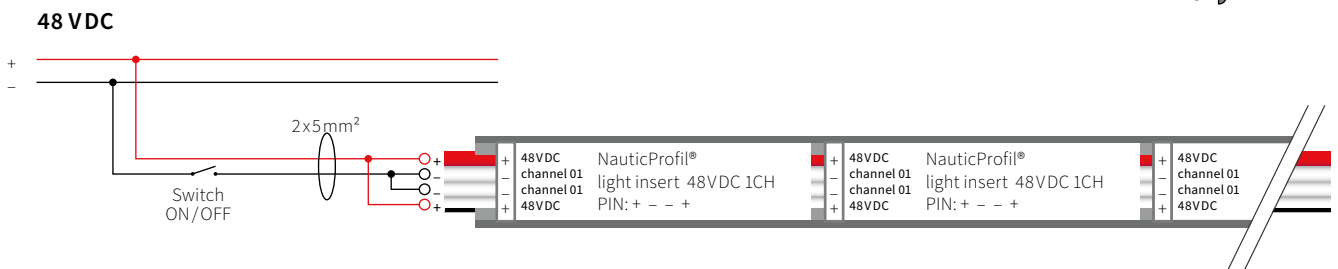
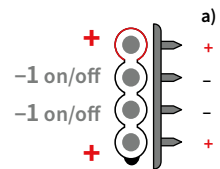

* Standard PIN-Belegung ist + - - + (WD/D/PWM/1a) / Weitere Verdrahtungsschemata in unserem aktuellen Katalog.
standard pin layout is + - - + (WD/D/PWM/1a) / further cabling scheme in our current catalogue.

NP Jago-2



42m per feed-in | 3112 lm/m* | CRI > 90 | 2200 K-6500 K

Hoher Lichtstrom und
hervorragende Farbwiedergabe
High luminous flux and
excellent colour rendering

Egal ob gerichtete oder diffuse Abstrahlung, mit unserem **NauticProfil® Jago-2** schaffen Sie herausragende, lange Lichtlinien mit einem exzellenten Farbwiedergabewert von CRI > 90. Das NauticProfil® Jago-2 ist prädestiniert für hochwertige Allgemeinbeleuchtungen in Büros, Fachgeschäften und repräsentativen Räumen, Ausstellungen oder Galerien. Es ist die ideale Lösung, wenn Farben besonders brillant und naturgetreu wiedergegeben werden müssen. Fünf Farbtemperaturen stehen zur Auswahl.

Whether directional or diffuse distribution, with our **NauticProfil® Jago-2** you create outstanding, long light lines with an excellent colour rendering value of CRI > 90. The NauticProfil® Jago-2 is predestined for high-quality general lighting in offices, specialist shops, and prestigious rooms, exhibitions, or galleries. It is the ideal solution when colours need to be reproduced in a particularly brilliant and natural way. Five colour temperatures are available.

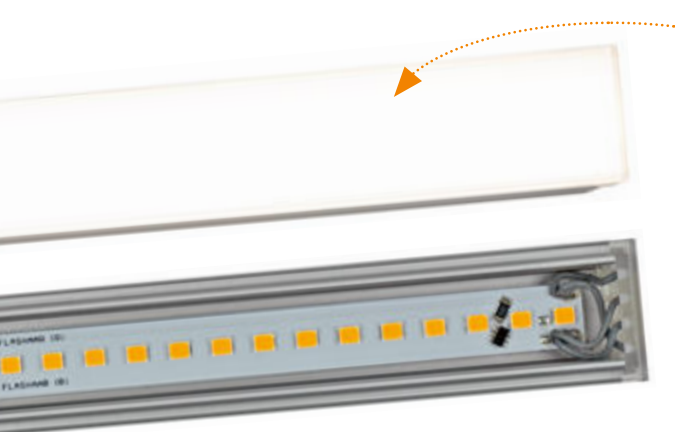

brillantes Licht
für hochwertige
Beleuchtungen

brilliant light for
high quality lighting

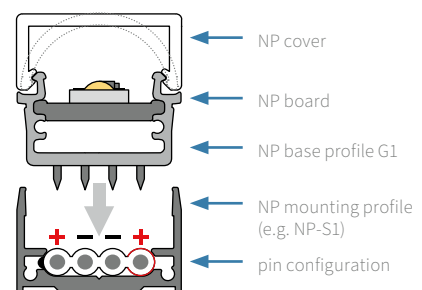
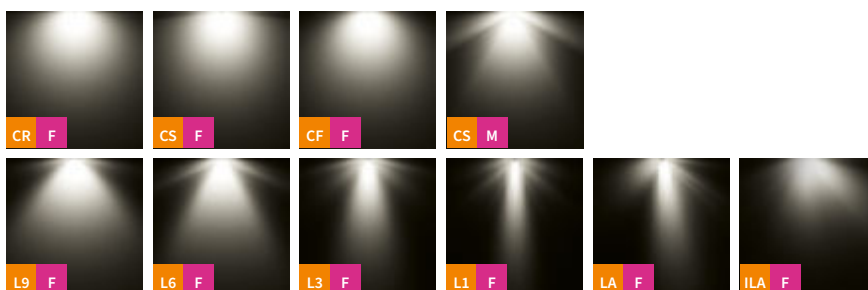

48V DC | 300g | IP40

PWM dimmable

IP65 | IP65 PREMIUM | IK10 | RAL optional

mounting



* Alle Angaben zum Lumenstrom beziehen sich auf das Leuchtmittel. In Kombination mit Cover/Linsen kommt es zu materialbedingtem Lichtverlust.
All information about the luminous flux refers to the light source. In combination with covers/lenses it comes to material-related light loss.

Bestellnummer
item number

NP/L1C/G1/19B / L1C/G1/ 112 / G1/ ALA / 9 27 / CR W

Technische Daten technical data

nominal voltage: 48VDC (Range: 44,25 to 49,5VDC)
 nominal wattage: 24W/m
 photometric code: 9XX/339; CRI > 90
 luminous efficiency [typ]: 135lm/W
 LED service life: L90/B10 > 100000h
 dimmable: pulse width modulation (PWM)
 length dividing matrix: 100 mm
 LED pitch: 6,64 mm, 150 LEDs/m
 max. length per feed-in: L(max) DIMMED = 42 m (1110 W)*
 2 x 16A PWM dimmer, cabling scheme D/PWM/2bb
 L(max) NOT DIMMED = 42 m (1110 W)*,
 according to cabling scheme S/1

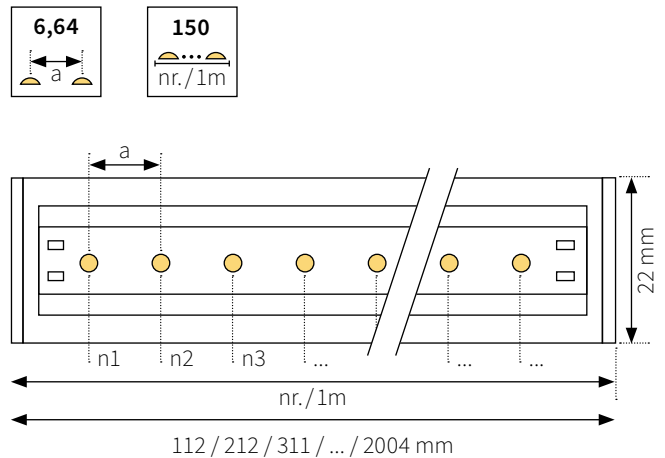

⚠ Achtung! Die Leistung [W] gesamt im NP System ist gleichmäßig auf die Kanäle 1+2 aufzuteilen.
Attention! The total power [W] in the NP system is to be divided equally between channels 1+2.

⚠ Alle optischen und elektrischen Daten haben eine Toleranz von +/- 10%.
 All optical and electrical data have a tolerance of +/- 10%.

Basisprofil base profile

Das **Basisprofil G1** ist mit allen NP Montageprofilen von FLASHAAR® per Plug&Play kombinierbar. Es ist in den Farben Aluminium (ALA) und Schwarz (BA) eloxiert erhältlich.
 The **base profile G1** can be combined with all NP mounting profiles from FLASHAAR® by Plug & Play. It is available in the colours aluminium (ALA) and black (BA) anodised.

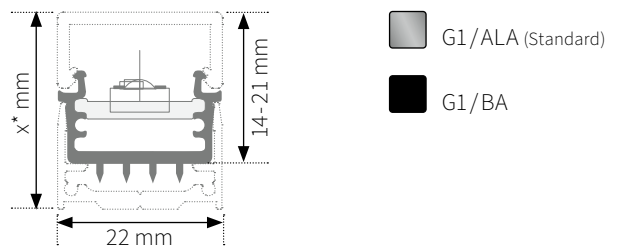

* Leuchtenhöhe abhängig vom Montageprofil (21-168 mm), Maße ab S. 8
 luminaire height depending on mounting profile (21-168 mm), dimensions from p. 8

Farbtemperatur und Lumenstrom colour temperature and luminous flux

	WW 2200 K**	WW 2700 K	WW 3000 K	NW 4000 K	DL 6500 K**
Farbtemperatur colour temperature	WW 2200 K**	WW 2700 K	WW 3000 K	NW 4000 K	DL 6500 K**
CRI typ.	93	94	93	92	91
Lumenstrom typ. luminous flux* typ.	2622lm/m	3112lm/m	3272lm/m	3496lm/m	3522lm/m
	922	927	930	940	965

* Alle Angaben zum Lumenstrom beziehen sich auf das Leuchtmittel. In Kombination mit Cover/Linsen kommt es zu materialbedingtem Lichtverlust.
 All information about the luminous flux refers to the light source. In combination with covers/lenses it comes to material-related light loss.

**Farbtemperatur auf Anfrage.
 Colour temperature on request.

Übersicht Standardlängen & Wattagen overview standard lengths & wattages

IP40, IP65, IP65 Premium		
product-nr.	L (mm)*	Watt**
NP/L1C/G1/19B/L1C/G1/0112/###/###	112	2,40
NP/L1C/G1/19B/L1C/G1/0212/###/###	212	4,80
NP/L1C/G1/19B/L1C/G1/0311/###/###	311	7,20
NP/L1C/G1/19B/L1C/G1/0411/###/###	411	9,60
NP/L1C/G1/19B/L1C/G1/0510/###/###	510	12,00
NP/L1C/G1/19B/L1C/G1/0610/###/###	610	14,40
NP/L1C/G1/19B/L1C/G1/0710/###/###	710	16,80
NP/L1C/G1/19B/L1C/G1/0809/###/###	809	19,20
NP/L1C/G1/19B/L1C/G1/0909/###/###	909	21,60
NP/L1C/G1/19B/L1C/G1/1008/###/###	1008	24,00

IP40		
product-nr.	L (mm)*	Watt**
NP/L1C/G1/19B/L1C/G1/1108/###/###	1108	26,40
NP/L1C/G1/19B/L1C/G1/1208/###/###	1208	28,80
NP/L1C/G1/19B/L1C/G1/1307/###/###	1307	31,20
NP/L1C/G1/19B/L1C/G1/1407/###/###	1407	33,60
NP/L1C/G1/19B/L1C/G1/1506/###/###	1506	36,00
NP/L1C/G1/19B/L1C/G1/1606/###/###	1606	38,40
NP/L1C/G1/19B/L1C/G1/1706/###/###	1706	40,80
NP/L1C/G1/19B/L1C/G1/1805/###/###	1805	43,20
NP/L1C/G1/19B/L1C/G1/1905/###/###	1905	45,60
NP/L1C/G1/19B/L1C/G1/2004/###/###	2004	48,00











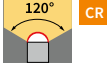



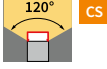





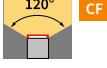



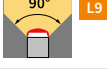









Übersicht der möglichen Sonderlängen & Wattagen (nach Rücksprache) overview of possible special lengths & wattages (after consultation)

IP40, IP65, IP65 Premium		
product-nr.	L (mm)*	Watt**
NP/L1C/G1/19B/SL1C/G1/0271/###/###	271	7,20
NP/L1C/G1/19B/SL1C/G1/0351/###/###	351	9,60
NP/L1C/G1/19B/SL1C/G1/0371/###/###	371	9,60
NP/L1C/G1/19B/SL1C/G1/0451/###/###	451	12,00
NP/L1C/G1/19B/SL1C/G1/0471/###/###	471	12,00
NP/L1C/G1/19B/SL1C/G1/0530/###/###	530	14,40
NP/L1C/G1/19B/SL1C/G1/0550/###/###	550	14,40
NP/L1C/G1/19B/SL1C/G1/0570/###/###	570	14,40
NP/L1C/G1/19B/SL1C/G1/0630/###/###	630	16,80
NP/L1C/G1/19B/SL1C/G1/0650/###/###	650	16,80
NP/L1C/G1/19B/SL1C/G1/0670/###/###	670	16,80
NP/L1C/G1/19B/SL1C/G1/0690/###/###	690	19,20
NP/L1C/G1/19B/SL1C/G1/0730/###/###	730	19,20
NP/L1C/G1/19B/SL1C/G1/0750/###/###	750	19,20
NP/L1C/G1/19B/SL1C/G1/0769/###/###	769	19,20
NP/L1C/G1/19B/SL1C/G1/0789/###/###	789	21,60
NP/L1C/G1/19B/SL1C/G1/0829/###/###	829	21,60
NP/L1C/G1/19B/SL1C/G1/0849/###/###	849	21,60
NP/L1C/G1/19B/SL1C/G1/0869/###/###	869	21,60
NP/L1C/G1/19B/SL1C/G1/0889/###/###	889	24,00
NP/L1C/G1/19B/SL1C/G1/0929/###/###	929	24,00
NP/L1C/G1/19B/SL1C/G1/0949/###/###	949	24,00
NP/L1C/G1/19B/SL1C/G1/0969/###/###	969	24,00
NP/L1C/G1/19B/SL1C/G1/0989/###/###	989	26,40

IP40		
product-nr.	L (mm)*	Watt**
NP/L1C/G1/19B/SL1C/G1/1028/###/###	1028	26,40
NP/L1C/G1/19B/SL1C/G1/1048/###/###	1048	26,40
NP/L1C/G1/19B/SL1C/G1/1068/###/###	1068	26,40
NP/L1C/G1/19B/SL1C/G1/1088/###/###	1088	28,80
NP/L1C/G1/19B/SL1C/G1/1128/###/###	1128	28,80
NP/L1C/G1/19B/SL1C/G1/1148/###/###	1148	28,80
NP/L1C/G1/19B/SL1C/G1/1168/###/###	1168	28,80
NP/L1C/G1/19B/SL1C/G1/1188/###/###	1188	31,20
NP/L1C/G1/19B/SL1C/G1/1228/###/###	1228	31,20
NP/L1C/G1/19B/SL1C/G1/1248/###/###	1248	31,20
NP/L1C/G1/19B/SL1C/G1/1267/###/###	1267	31,20
NP/L1C/G1/19B/SL1C/G1/1287/###/###	1287	33,60
NP/L1C/G1/19B/SL1C/G1/1327/###/###	1327	33,60
NP/L1C/G1/19B/SL1C/G1/1347/###/###	1347	33,60
NP/L1C/G1/19B/SL1C/G1/1367/###/###	1367	33,60
NP/L1C/G1/19B/SL1C/G1/1387/###/###	1387	36,00
NP/L1C/G1/19B/SL1C/G1/1427/###/###	1427	36,00
NP/L1C/G1/19B/SL1C/G1/1447/###/###	1447	36,00
NP/L1C/G1/19B/SL1C/G1/1467/###/###	1467	36,00
NP/L1C/G1/19B/SL1C/G1/1487/###/###	1487	38,40
NP/L1C/G1/19B/SL1C/G1/1526/###/###	1526	38,40
NP/L1C/G1/19B/SL1C/G1/1546/###/###	1546	38,40
NP/L1C/G1/19B/SL1C/G1/1566/###/###	1566	38,40
NP/L1C/G1/19B/SL1C/G1/1586/###/###	1586	40,80
NP/L1C/G1/19B/SL1C/G1/1626/###/###	1626	40,80
NP/L1C/G1/19B/SL1C/G1/1646/###/###	1646	40,80
NP/L1C/G1/19B/SL1C/G1/1666/###/###	1666	40,80
NP/L1C/G1/19B/SL1C/G1/1686/###/###	1686	43,20
NP/L1C/G1/19B/SL1C/G1/1726/###/###	1726	43,20
NP/L1C/G1/19B/SL1C/G1/1746/###/###	1746	43,20
NP/L1C/G1/19B/SL1C/G1/1765/###/###	1765	43,20
NP/L1C/G1/19B/SL1C/G1/1785/###/###	1785	45,60
NP/L1C/G1/19B/SL1C/G1/1825/###/###	1825	45,60
NP/L1C/G1/19B/SL1C/G1/1845/###/###	1845	45,60
NP/L1C/G1/19B/SL1C/G1/1865/###/###	1865	45,60
NP/L1C/G1/19B/SL1C/G1/1885/###/###	1885	48,00
NP/L1C/G1/19B/SL1C/G1/1925/###/###	1925	48,00
NP/L1C/G1/19B/SL1C/G1/1945/###/###	1945	48,00
NP/L1C/G1/19B/SL1C/G1/1965/###/###	1965	48,00
NP/L1C/G1/19B/SL1C/G1/1985/###/###	1985	50,40

⚠️ Achtung! Im Außenbereich (IP65 und IP65 Premium) ist maximal ein Leuchteneinsatz in der Länge von 112 mm bis 1008 mm realisierbar. LED-Teilungsraster ist 100 mm.
Attention! In outdoor areas (IP65 and IP65 Premium), a maximum of one luminaire insert can be realised in lengths from 112 mm to 1008 mm. The grid uses 100mm increments

**Leistungsangaben +/- 10% | performance data +/- 10%

covers & lenses	T	F	W	G	M
cover round 120° 	2926 lm/m 	2792 lm/m 	1262 lm/m 		
cover square 120° 	2820 lm/m 	2584 lm/m 	1452 lm/m 	1030 lm/m 	2260 lm/m 
cover flat 120° 	2720 lm/m 	2470 lm/m 	1370 lm/m 		
lens 90° 	2852 lm/m 	2750 lm/m 			
lens 60° 	2902 lm/m 	2756 lm/m 			
lens 30° 	2756 lm/m 	2600 lm/m 			
lens 15° 		2626 lm/m 			
lens LAF-2 asymmetric 		2582 lm/m 			
lens ILAF asymmetric (IP65 P) 	1658 lm/m 				
<p>Alle Werte in der Tabelle gemessen bei 2700 K. Messwerte unterliegen den typischen Toleranzen. Andere Konfigurationen erhalten Sie auf Anfrage. All values in the table measured at 2700 K. Measured values are subject to the typical tolerances. Other configurations are available on request.</p> <p>Alle lichttechnischen Daten – vermessen im FLASHAAR® Lichtlabor – finden Sie unter flashaar.de im Download-Bereich. All photometric data – measured in FLASHAAR's light laboratory – available at flashaar.de/en in the download area.</p> <p>Alle optischen und elektrischen Daten haben eine Toleranz von +/- 10%. All optical and electrical data have a tolerance of +/- 10%.</p> <p>Messdaten für IP65 / IP65 Premium auf Anfrage. Measurement data for IP65 / IP65 Premium on request.</p>					<p>EPREL-Daten: 2200 K </p> <p>2700 K </p> <p>3000 K </p> <p>4000 K </p> <p>6500 K </p>



Liederhalle Stuttgart

Über 1300 Meter lineare LED-Leuchten der Firma FLASHAAR® erhellen den neu sanierten Kongressbereich des Kultur- und Kongresszentrums Liederhalle Stuttgart. Im Zeichen der Nachhaltigkeit wurden für die Publikumsbeleuchtung rund 4.500 energieeffiziente LED-Leuchten eingebaut.

More than 1,300 metres of linear LED luminaires from FLASHAAR® illuminate the newly refurbished congress area of the Liederhalle Culture and Congress Centre in Stuttgart. In the spirit of sustainability, around 4,500 energy-efficient LED luminaires were installed for the audience lighting.

Verdrahtungsschemata wiring diagrams

Beispiel für max. Länge mit einer elektrischen Einspeisung.*
example for max. length with one electrical feed.*

WD/D/PWM/1a (1x1CH)

Dimmbar mittels PWM, System mit 1 Kanal, 48VDC /
1CH Leuchteneinsätze mit redundanter PIN-Belegung
dimnable by PWM, system with 1 channel, 48VDC /
1CH light insert with double PIN connection
max. **25 m** (665 W) pro Einspeisung / max. 25 m (665 W) per feed in

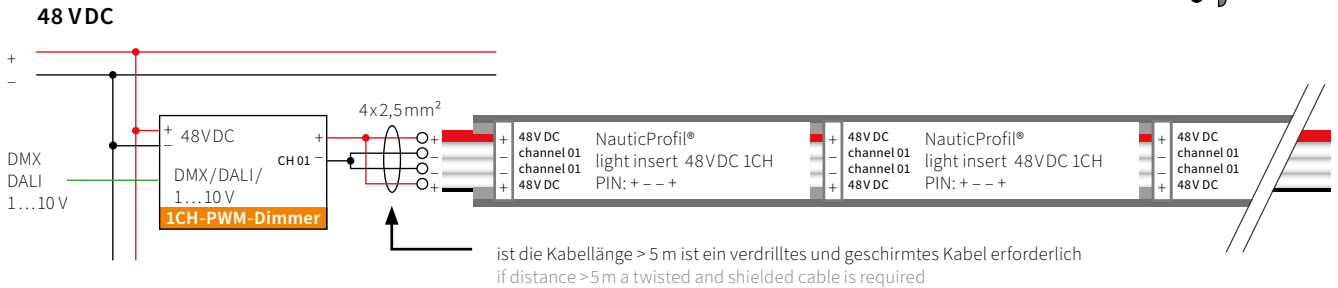
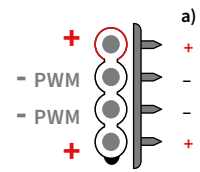

WD/D/PWM/2bb (2x1CH)

Dimmbar mittels PWM, System mit 2 Dimmern 1CH, 48 VDC / 1CH
Leuchteneinsätze
dimnable by PWM, system with 2 dimmer 1CH, 48 VDC / 1CH light insert
max. **42 m** (1110 W) pro Einspeisung / max. 42 m (1110 W) per feed in

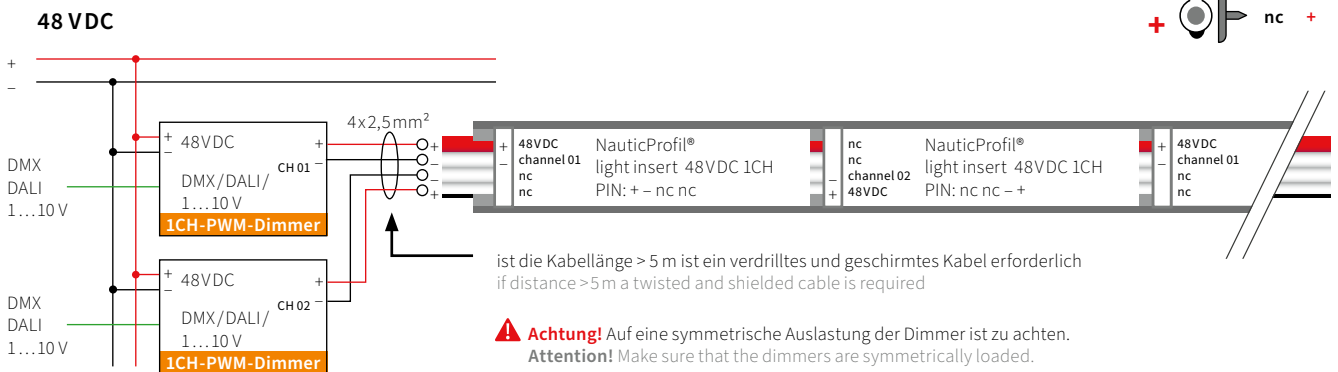
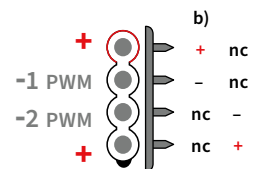

WD/S/1a (1x1CH)

Schaltbar, System mit 1 Kanal /
1CH Leuchteneinsätze mit redundanter PIN-Belegung
to switch ON/OFF, system with 1-channel /
1CH light insert with double PIN connection
max. **45 m** (1185 W) pro Einspeisung / max. 45 m (1185 W) per feed in

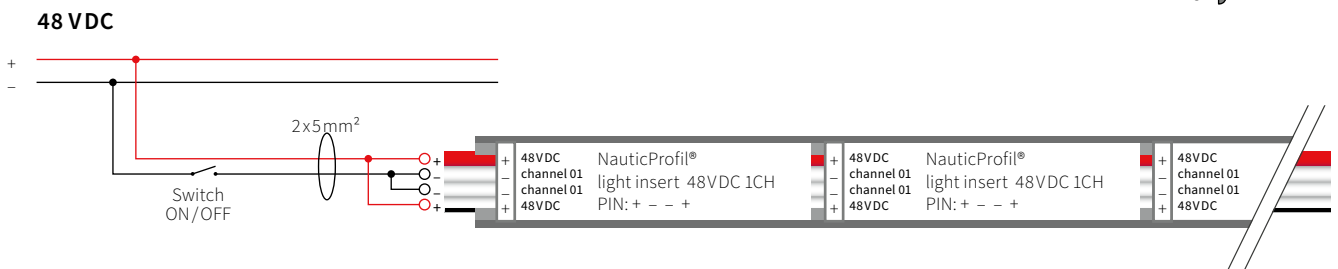
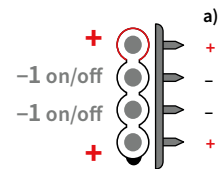

* Standard PIN-Belegung ist + - - + (WD/D/PWM/1a) / Weitere Verdrahtungsschemata in unserem aktuellen Katalog.
standard pin layout is + - - + (WD/D/PWM/1a) / further cabling scheme in our current catalogue.

NP Nova-6



42m per feed-in | 3790 lm/m* | CRI > 80 | 2200 K-6500 K

Bis zu 4100 Lumen / Meter –
so hell wie wirtschaftlich
Up to 4000 lumen/metre –
as bright as economic

Unser ebenso lichtstarkes wie wirtschaftliches **NauticProfil® Nova-6** ist der perfekte Ersatz für Anwendungen, bei denen früher Leuchtstoffröhren zum Einsatz gekommen sind.

In Hallen, Fluren und Treppenhäusern sorgt es für ideale Lichtverhältnisse bei niedrigem Energieverbrauch. Dank des optimalen Preis-Leistungsverhältnisses, der geringeren Installationskosten und einer sehr hohen Lebensdauer, ist unser NP Nova-6 die ideale Wahl für viele Lichtlösungen bei Anwendungen im Innen- und Außenbereich. Es stehen fünf Farbtemperaturen zur Auswahl.

Our **NauticProfil® Nova-6**, which is as bright as it is economical, is the perfect replacement for applications where fluorescent tubes were previously used. In halls, corridors and stairwells, it provides ideal lighting conditions with low energy consumption. Thanks to the optimal price/performance ratio, lower installation costs, and a very long service life, our NP Nova-6 is the ideal choice for many lighting solutions in indoor and outdoor applications. There are five colour temperatures to choose from.

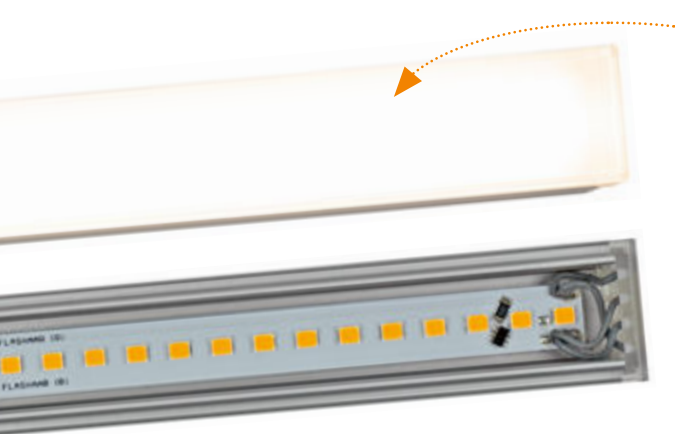

optimale Beleuchtung
für unzählige
Anwendungsbereiche

optimum lighting
for countless areas
of application

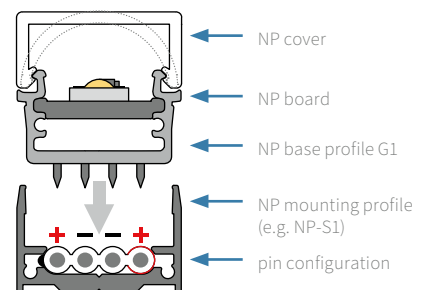

48V DC | 300g | IP40

characteristics

PWM dimmable

dimming

IP65 | IP65 PREMIUM | IK10 | RAL optional

optional

mounting

* Alle Angaben zum Lumenstrom beziehen sich auf das Leuchtmittel. In Kombination mit Cover/Linsen kommt es zu materialbedingtem Lichtverlust.
All information about the luminous flux refers to the light source. In combination with covers/lenses it comes to material-related light loss.

Bestellnummer
item number

NP/L1C/G1/06F / L1C/G1/ 112 / G1/ ALA / 8 27 / CR W

Technische Daten
technical data

nominal voltage: 48VDC (Range: 44,25 to 49,5VDC)
 nominal wattage: 24W/m
 photometric code: 8XX/339; CRI > 80
 luminous efficiency [typ]: 164 lm/W
 LED service life: L90/B10 > 100000h
 dimmable: pulse width modulation (PWM)
 length dividing matrix: 100mm
 LED pitch: 6,64mm, 150 LEDs/m
 max. length per feed-in: L(max) DIMMED = 42m (1110W)*
 2 x 16A PWM dimmer, cabling scheme D/PWM/2bb
 L(max) NOT DIMMED = 42m (1110W)*,
 according to cabling scheme S/1

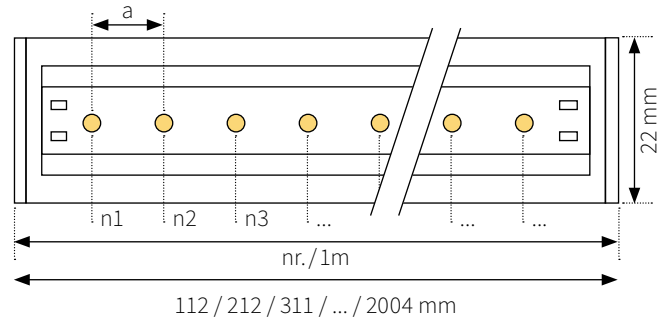

⚠ Achtung! Die Leistung [W] gesamt im NP System ist gleichmäßig auf die Kanäle 1+2 aufzuteilen.
Attention! The total power [W] in the NP system is to be divided equally between channels 1+2.

⚠ Alle optischen und elektrischen Daten haben eine Toleranz von +/- 10%.
 All optical and electrical data have a tolerance of +/- 10%.

Basisprofil
base profile

Das **Basisprofil G1** ist mit allen NP Montageprofilen von FLASHAAR® per Plug&Play kombinierbar. Es ist in den Farben Aluminium (ALA) und Schwarz (BA) eloxiert erhältlich.
 The **base profile G1** can be combined with all NP mounting profiles from FLASHAAR® by Plug & Play. It is available in the colours aluminium (ALA) and black (BA) anodised.

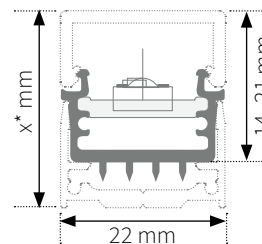

- G1/ALA (Standard)
- G1/BA

* Leuchtenhöhe abhängig vom Montageprofil (21-168 mm), Maße ab S. 8
 luminaire height depending on mounting profile (21-168 mm), dimensions from p. 8

Farbtemperatur und Lumenstrom
colour temperature and luminous flux

	WW 2200 K**	WW 2700 K	WW 3000 K	NW 4000 K	DL 6500 K**
Farbtemperatur colour temperature	WW 2200 K**	WW 2700 K	WW 3000 K	NW 4000 K	DL 6500 K**
CRI typ.	82	82	83	82	81
Lumenstrom typ. luminous flux* typ.	3180 lm/m	3790 lm/m	3920 lm/m	4122 lm/m	4106 lm/m
	822	827	830	840	865

* Alle Angaben zum Lumenstrom beziehen sich auf das Leuchtmittel. In Kombination mit Cover/Linsen kommt es zu materialbedingtem Lichtverlust.
 All information about the luminous flux refers to the light source. In combination with covers/lenses it comes to material-related light loss.

**Farbtemperatur auf Anfrage.
 Colour temperature on request.

Übersicht Standardlängen & Wattagen

overview standard lengths & wattages

IP40, IP65, IP65 Premium		
product-nr.	L (mm)*	Watt**
NP/L1C/G1/06F/L1C/G1/0112/###/###	112	2,40
NP/L1C/G1/06F/L1C/G1/0212/###/###	212	4,80
NP/L1C/G1/06F/L1C/G1/0311/###/###	311	7,20
NP/L1C/G1/06F/L1C/G1/0411/###/###	411	9,60
NP/L1C/G1/06F/L1C/G1/0510/###/###	510	12,00
NP/L1C/G1/06F/L1C/G1/0610/###/###	610	14,40
NP/L1C/G1/06F/L1C/G1/0710/###/###	710	16,80
NP/L1C/G1/06F/L1C/G1/0809/###/###	809	19,20
NP/L1C/G1/06F/L1C/G1/0909/###/###	909	21,60
NP/L1C/G1/06F/L1C/G1/1008/###/###	1008	24,00

IP40		
product-nr.	L (mm)*	Watt**
NP/L1C/G1/06F/L1C/G1/1108/###/###	1108	26,40
NP/L1C/G1/06F/L1C/G1/1208/###/###	1208	28,80
NP/L1C/G1/06F/L1C/G1/1307/###/###	1307	31,20
NP/L1C/G1/06F/L1C/G1/1407/###/###	1407	33,60
NP/L1C/G1/06F/L1C/G1/1506/###/###	1506	36,00
NP/L1C/G1/06F/L1C/G1/1606/###/###	1606	38,40
NP/L1C/G1/06F/L1C/G1/1706/###/###	1706	40,80
NP/L1C/G1/06F/L1C/G1/1805/###/###	1805	43,20
NP/L1C/G1/06F/L1C/G1/1905/###/###	1905	45,60
NP/L1C/G1/06F/L1C/G1/2004/###/###	2004	48,00

Übersicht der möglichen Sonderlängen & Wattagen (nach Rücksprache)











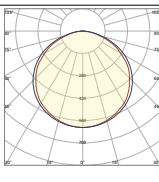
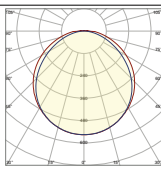
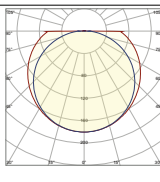

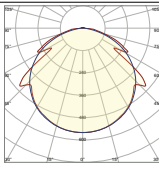
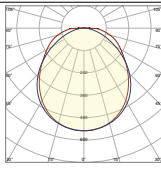
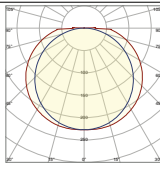
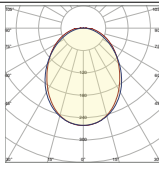
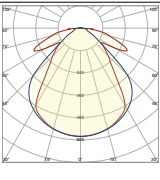

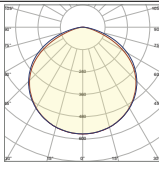
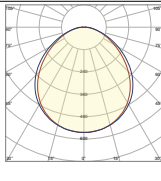
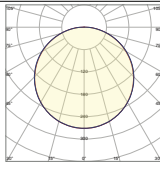

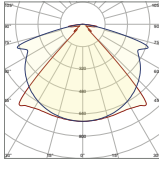
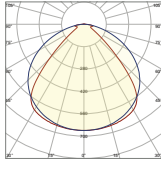

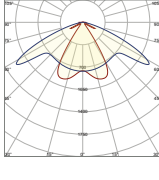
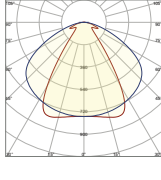

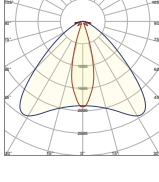
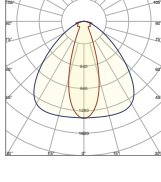

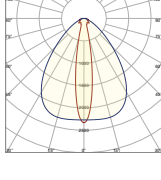
overview of possible special lengths & wattages (after consultation)

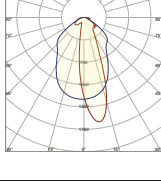
IP40, IP65, IP65 Premium		
product-nr.	L (mm)*	Watt**
NP/L1C/G1/06F/SL1C/G1/0271/###/###	271	7,20
NP/L1C/G1/06F/SL1C/G1/0351/###/###	351	9,60
NP/L1C/G1/06F/SL1C/G1/0371/###/###	371	9,60
NP/L1C/G1/06F/SL1C/G1/0451/###/###	451	12,00
NP/L1C/G1/06F/SL1C/G1/0471/###/###	471	12,00
NP/L1C/G1/06F/SL1C/G1/0530/###/###	530	14,40
NP/L1C/G1/06F/SL1C/G1/0550/###/###	550	14,40
NP/L1C/G1/06F/SL1C/G1/0570/###/###	570	14,40
NP/L1C/G1/06F/SL1C/G1/0630/###/###	630	16,80
NP/L1C/G1/06F/SL1C/G1/0650/###/###	650	16,80
NP/L1C/G1/06F/SL1C/G1/0670/###/###	670	16,80
NP/L1C/G1/06F/SL1C/G1/0690/###/###	690	19,20
NP/L1C/G1/06F/SL1C/G1/0730/###/###	730	19,20
NP/L1C/G1/06F/SL1C/G1/0750/###/###	750	19,20
NP/L1C/G1/06F/SL1C/G1/0769/###/###	769	19,20
NP/L1C/G1/06F/SL1C/G1/0789/###/###	789	21,60
NP/L1C/G1/06F/SL1C/G1/0829/###/###	829	21,60
NP/L1C/G1/06F/SL1C/G1/0849/###/###	849	21,60
NP/L1C/G1/06F/SL1C/G1/0869/###/###	869	21,60
NP/L1C/G1/06F/SL1C/G1/0889/###/###	889	24,00
NP/L1C/G1/06F/SL1C/G1/0929/###/###	929	24,00
NP/L1C/G1/06F/SL1C/G1/0949/###/###	949	24,00
NP/L1C/G1/06F/SL1C/G1/0969/###/###	969	24,00
NP/L1C/G1/06F/SL1C/G1/0989/###/###	989	26,40

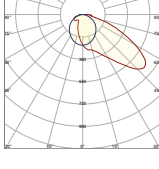
IP40		
product-nr.	L (mm)*	Watt**
NP/L1C/G1/06F/SL1C/G1/1028/###/###	1028	26,40
NP/L1C/G1/06F/SL1C/G1/1048/###/###	1048	26,40
NP/L1C/G1/06F/SL1C/G1/1068/###/###	1068	26,40
NP/L1C/G1/06F/SL1C/G1/1088/###/###	1088	28,80
NP/L1C/G1/06F/SL1C/G1/1128/###/###	1128	28,80
NP/L1C/G1/06F/SL1C/G1/1148/###/###	1148	28,80
NP/L1C/G1/06F/SL1C/G1/1168/###/###	1168	28,80
NP/L1C/G1/06F/SL1C/G1/1188/###/###	1188	31,20
NP/L1C/G1/06F/SL1C/G1/1228/###/###	1228	31,20
NP/L1C/G1/06F/SL1C/G1/1248/###/###	1248	31,20
NP/L1C/G1/06F/SL1C/G1/1267/###/###	1267	31,20
NP/L1C/G1/06F/SL1C/G1/1287/###/###	1287	33,60
NP/L1C/G1/06F/SL1C/G1/1327/###/###	1327	33,60
NP/L1C/G1/06F/SL1C/G1/1347/###/###	1347	33,60
NP/L1C/G1/06F/SL1C/G1/1367/###/###	1367	33,60
NP/L1C/G1/06F/SL1C/G1/1387/###/###	1387	36,00
NP/L1C/G1/06F/SL1C/G1/1427/###/###	1427	36,00
NP/L1C/G1/06F/SL1C/G1/1447/###/###	1447	36,00
NP/L1C/G1/06F/SL1C/G1/1467/###/###	1467	36,00
NP/L1C/G1/06F/SL1C/G1/1487/###/###	1487	38,40
NP/L1C/G1/06F/SL1C/G1/1526/###/###	1526	38,40
NP/L1C/G1/06F/SL1C/G1/1546/###/###	1546	38,40
NP/L1C/G1/06F/SL1C/G1/1566/###/###	1566	38,40
NP/L1C/G1/06F/SL1C/G1/1586/###/###	1586	40,80
NP/L1C/G1/06F/SL1C/G1/1626/###/###	1626	40,80
NP/L1C/G1/06F/SL1C/G1/1646/###/###	1646	40,80
NP/L1C/G1/06F/SL1C/G1/1666/###/###	1666	40,80
NP/L1C/G1/06F/SL1C/G1/1686/###/###	1686	43,20
NP/L1C/G1/06F/SL1C/G1/1726/###/###	1726	43,20
NP/L1C/G1/06F/SL1C/G1/1746/###/###	1746	43,20
NP/L1C/G1/06F/SL1C/G1/1765/###/###	1765	43,20
NP/L1C/G1/06F/SL1C/G1/1785/###/###	1785	45,60
NP/L1C/G1/06F/SL1C/G1/1825/###/###	1825	45,60
NP/L1C/G1/06F/SL1C/G1/1845/###/###	1845	45,60
NP/L1C/G1/06F/SL1C/G1/1865/###/###	1865	45,60
NP/L1C/G1/06F/SL1C/G1/1885/###/###	1885	48,00
NP/L1C/G1/06F/SL1C/G1/1925/###/###	1925	48,00
NP/L1C/G1/06F/SL1C/G1/1945/###/###	1945	48,00
NP/L1C/G1/06F/SL1C/G1/1965/###/###	1965	48,00
NP/L1C/G1/06F/SL1C/G1/1985/###/###	1985	50,40

⚠️ Achtung! Im Außenbereich (IP65 und IP65 Premium) ist maximal ein Leuchteneinsatz in der Länge von 112 mm bis 1008 mm realisierbar. LED-Teilungsraster ist 100 mm.
Attention! In outdoor areas (IP65 and IP65 Premium), a maximum of one luminaire insert can be realised in lengths from 112 mm to 1008 mm. The grid uses 100 mm increments

**Leistungsangaben +/- 10% | performance data +/- 10%

covers & lenses	T	F	W	G	M
cover round 120° 	3584 lm/m 	3384 lm/m 	1452 lm/m 		
cover square 120° 	3442 lm/m 	3146 lm/m 	1680 lm/m 	1264 lm/m 	2756 lm/m 
cover flat 120° 	3318 lm/m 	3002 lm/m 	1682 lm/m 		
lens 90° 	3478 lm/m 	3326 lm/m 			
lens 60° 	3530 lm/m 	3310 lm/m 			
lens 30° 	3284 lm/m 	3130 lm/m 			
lens 15° 		3120 lm/m 			
lens LAF-2 asymmetric 		3178 lm/m 			
lens ILAF asymmetric (IP65 P) 	1962 lm/m 				
<p>Alle Werte in der Tabelle gemessen bei 2700 K. Messwerte unterliegen den typischen Toleranzen. Andere Konfigurationen erhalten Sie auf Anfrage. All values in the table measured at 2700 K. Measured values are subject to the typical tolerances. Other configurations are available on request.</p> <p>Alle lichttechnischen Daten – vermessen im FLASHAAR® Lichtlabor – finden Sie unter flashaar.de im Download-Bereich. All photometric data – measured in FLASHAAR's light laboratory – available at flashaar.de/en in the download area.</p> <p>Alle optischen und elektrischen Daten haben eine Toleranz von +/- 10%. All optical and electrical data have a tolerance of +/- 10%.</p> <p>Messdaten für IP65 / IP65 Premium auf Anfrage. Measurement data for IP65 / IP65 Premium on request.</p>					<p>EPREL-Daten: 2200 K </p> <p>2700 K </p> <p>3000 K </p> <p>4000 K </p> <p>6500 K </p>

Verdrahtungsschemata wiring diagrams

Beispiel für max. Länge mit einer elektrischen Einspeisung.*
example for max. length with one electrical feed.*

WD/D/PWM/1a (1x1CH)

Dimmbar mittels PWM, System mit 1 Kanal, 48VDC /
1CH Leuchteneinsätze mit redundanter PIN-Belegung
dimnable by PWM, system with 1 channel, 48VDC /
1CH light insert with double PIN connection
max. **25 m** (665 W) pro Einspeisung / max. 25 m (665 W) per feed in



WD/D/PWM/2bb (2x1CH)

Dimmbar mittels PWM, System mit 2 Dimmern 1CH, 48 VDC / 1CH
Leuchteneinsätze
dimnable by PWM, system with 2 dimmer 1CH, 48 VDC / 1CH light insert
max. **42 m** (1110 W) pro Einspeisung / max. 42 m (1110 W) per feed in

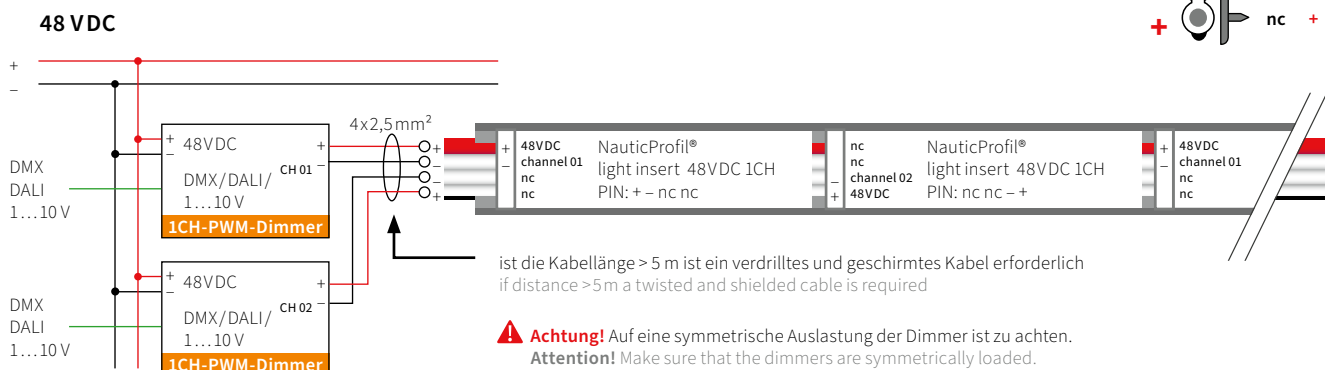

WD/S/1a (1x1CH)

Schaltbar, System mit 1 Kanal /
1CH Leuchteneinsätze mit redundanter PIN-Belegung
to switch ON/OFF, system with 1-channel /
1CH light insert with double PIN connection
max. **45 m** (1185 W) pro Einspeisung / max. 45 m (1185 W) per feed in

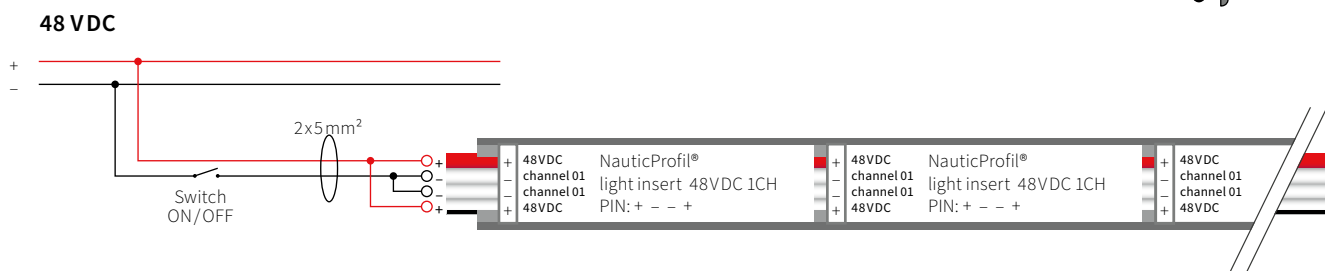

* Standard PIN-Belegung ist + - - + (WD/D/PWM/1a) / Weitere Verdrahtungsschemata in unserem aktuellen Katalog.
standard pin layout is + - - + (WD/D/PWM/1a) / further cabling scheme in our current catalogue.



Cosimawellenbad in München

Pegasus-4 Leuchteneinsätze sorgen für ein besonderes Wohlfühlambiente in den Ruheräumen. Im Bereich von 2200-3000 Kelvin produzieren Sie ein Licht, welches vom Menschen als besonders angenehm und warm empfunden wird.

Cosima wave pool in Munich

Pegasus-4 luminaire inserts create a special feel-good ambiance in the relaxation rooms. In the range of 2200-3000 Kelvin, they produce a light that is perceived by people as particularly pleasant and warm. 3000 Kelvin, they produce a light that is perceived by people as particularly pleasant and warm.

NP Pegasus-4

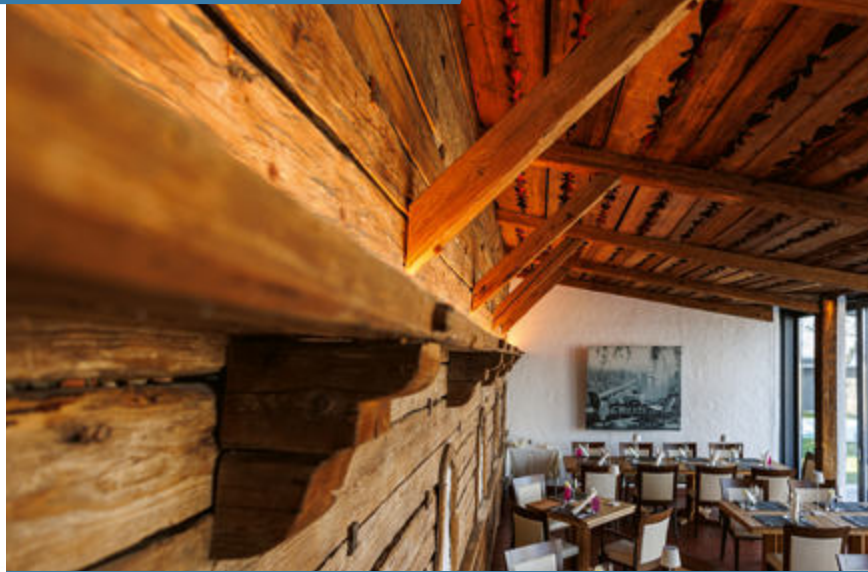

16m per feed-in | 2000 lm/m* | CRI 80/90 | 2200 K-5600 K

"Biodynamisches" Licht dank frei wählbarer Farbtemperatur.

"Biodynamic" light thanks to freely selectable colour temperature.

Unser **NauticProfil® Pegasus-4** ermöglicht leistungsstarke lineare Beleuchtungen mit einstellbarer Farbtemperatur. Zur Verfügung stehen jeweils zwei Farbtemperaturen pro LED-Linie. Standard sind entweder 2700 + 5600 K oder 2200 + 3000 / 4000 K. Von warmweißen 2200 K bis hin zu kaltweißen 5600 K lassen sich Lichtanwendungen, die den Tageslichtverlauf nachbilden und damit dem natürlichen Biorhythmus entsprechen, optimal umsetzen. 2000 lm/m sorgen für eine helle Grundbeleuchtung oder auch ein warmes Wohlfühlambiente in Restaurants, Hotels, Krankenhäusern, Büros, Verwaltungen oder Privatwohnungen.

Our **NauticProfil® Pegasus-4** enables powerful linear lighting with adjustable colour temperature. Two colour temperatures are available per LED line. Standard are either 2700 + 5600 K or 2200 + 3000 / 4000 K. From warm white 2200 K to cool white 5600 K, lighting applications that reproduce the course of daylight and thus correspond to the natural biorhythm can be optimally implemented. 2000 lm/m provides bright ambient lighting or a warm feel-good ambience in restaurants, hotels, hospitals, offices, administrations as well as private residences.

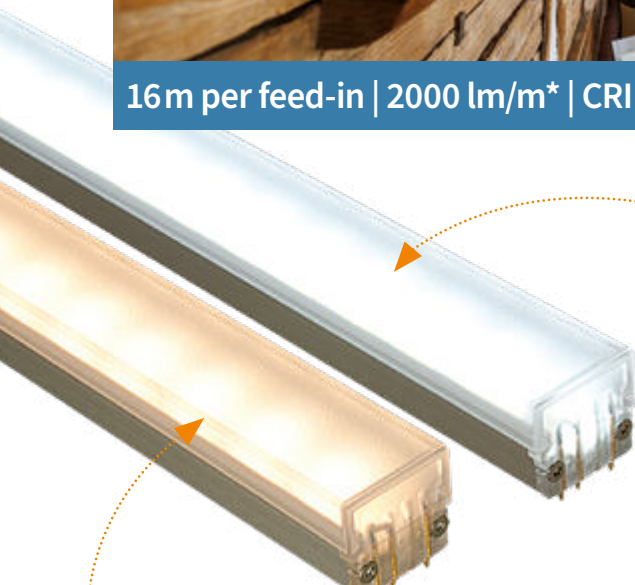

angenehm, wechselnde Lichtverhältnisse je nach Bedarf

pleasant, changing lighting conditions depending on as required

Goldenes Licht bei 2200 + 3000
golden light at 2200 + 3000 K

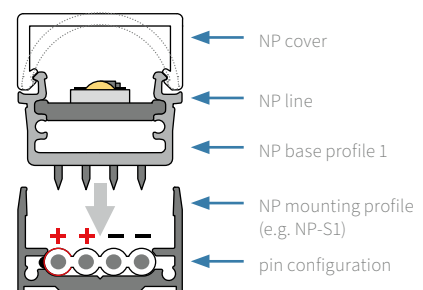
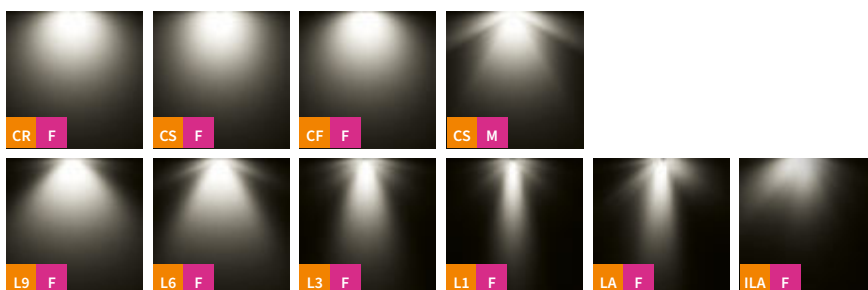

characteristics



dimming



optional



mounting



* Alle Angaben zum Lumenstrom beziehen sich auf das Leuchtmittel. In Kombination mit Cover /Linsen kommt es zu materialbedingtem Lichtverlust.

All information about the luminous flux refers to the light source. In combination with covers/lenses it comes to material-related light loss.

** Nur zugelassen für DALI DT8! Only approved for DALI DT8!

Bestellnummer
item number

NP/L2C/G1/09D

L2C/G1/ 0112

G1/ ALA

XXX/XXX

CR W

Technische Daten
technical data

nominal voltage: 24VDC (Range: 23,5 to 26VDC)
 nominal wattage:
 type I: 22 W/m CH1 (2700 K) | 20 W/m CH2 (5600 K)
GOLD = type II: 28 W/m CH1 (**2200K**) | 22 W/m CH2 (**3000 K**)
 type III: 28 W/m CH1 (2200K) | 17 W/m CH2 (4000K)
 photometric code:
 type I: 927/339 + 956/339; CRI typ. 90+90
GOLD = type II: 922/339 + 930/339; CRI typ. 93+92
 type III: 922/339 + 840/399; CRI typ. 93+80

luminous efficiency [typ.]: 101 lm/W (2700 K), 113 lm/W (5600 K)
 84 lm/W (2200 K), 109 lm/W (3000 K)
 135 lm/W (4000 K)

LED service life: L80/B10 > 100000h,
 L90/B10 > 100000h

dimmbare: pulse width modulation (PWM)
 length dividing matrix: 100 mm
 LED pitch: 62x8,30 mm, 2x60 LEDs/m
 max. length per feed-in:
 L(max) DIMMED = 14 m (2 x 355 W) CH1+CH2,
 with a 2 x 16A PWM dimmer, according to cabling scheme
 D/PWM/Pegasus-a

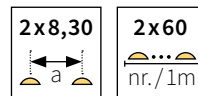
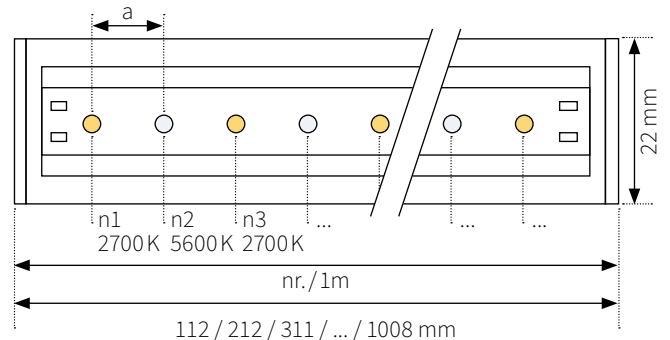

- ⚠️ * Achtung!** Der Betrieb beider Lichtfarben gleichzeitig auf 100% ist nicht zulässig! Auf ausreichende Kühlung ist zu achten.
Max. 24 W/m Gesamtleistung.
 Operating both light colours at 100% at the same time is not permitted!
 Sufficient cooling must be ensured. **Maximum total output 24 W/m**
- ⚠️** Alle optischen und elektrischen Daten haben eine Toleranz von +/- 10%.
 All optical and electrical data have a tolerance of +/- 10%.

Basisprofil
base profile

Das **Basisprofil G1** ist mit allen NP Montageprofilen von FLASHAAR® per Plug&Play kombinierbar. Es ist in den Farben Aluminium und Schwarz eloxiert erhältlich.
 The **base profile G1** can be combined with all NP mounting profiles from FLASHAAR® by Plug & Play. It is available in the colours aluminium and black anodised.

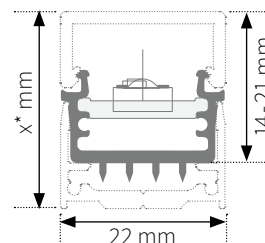

- G1/ALA (Standard)
- G1/BA

* Leuchtenhöhe abhängig vom Montageprofil (21-168 mm), Maße ab S. 11
 luminaire height depending on mounting profile (21-168 mm), dimensions from p. 11

Lichtwellenlänge und Lumenstrom
light wavelength and luminous flux

	GOLD = type II	type I	type III	type I	type I
Farbtemperatur colour temperature	WW 2200 K	WW 2700 K	WW 3000 K	NW 4000 K	DL 5600 K
CRI typ.	93	90	92	80	90
Lumenstrom typ. luminous flux* typ.	2470 lm/m	2290 lm/m	2370 lm/m	2266 lm/m	2276 lm/m
	922	927	930	840	956

* Alle Angaben zum Lumenstrom beziehen sich auf das Leuchtmittel. In Kombination mit Cover/Linsen kommt es zu materialbedingtem Lichtverlust.
 All information about the luminous flux refers to the light source. In combination with covers/lenses it comes to material-related light loss.
 **Farbtemperatur auf Anfrage.
 Colour temperature on request.



© Cafe-Restaurant Seehaus GmbH / Lukas Schürer

Übersicht Standardlängen & Wattagen overview standard lengths & wattages











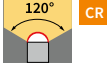

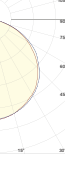
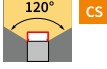

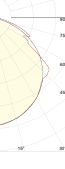

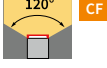



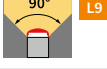





IP40, IP65							
product-Nr.	L (mm)	type I Watt 2700 + 5600 K*		type II Watt 2200 + 3000 K*		type III Watt 2200 + 4000 K*	
NP/L2C/G1/09D/L2C/G1/0112/###/...	112	2,69	2,46	2,96	2,42	2,96	2,00
NP/L2C/G1/09D/L2C/G1/0212/###/...	212	5,09	4,66	5,60	4,58	5,60	3,77
NP/L2C/G1/09D/L2C/G1/0311/###/...	311	7,46	6,84	8,21	6,72	8,21	5,54
NP/L2C/G1/09D/L2C/G1/0411/###/...	411	9,86	9,04	10,85	8,88	10,85	7,32
NP/L2C/G1/09D/L2C/G1/0510/###/...	510	12,42	11,22	13,46	11,01	13,46	9,08
NP/L2C/G1/09D/L2C/G1/0610/###/...	610	14,64	13,42	10,10	13,78	10,10	10,86
NP/L2C/G1/09D/L2C/G1/0710/###/...	710	17,04	15,62	18,74	15,34	18,74	12,64
NP/L2C/G1/09D/L2C/G1/0809/###/...	809	19,42	17,80	21,36	17,47	21,36	14,40
NP/L2C/G1/09D/L2C/G1/0909/###/...	909	21,82	20,00	24,00	19,63	24,00	16,18
NP/L2C/G1/09D/L2C/G1/1008/###/...	1008	24,19	22,18	26,61	21,77	26,61	17,94

* Leistungsangaben +/- 10% | performance data +/- 10%

Achtung! Bei Leuchten der Länge > 1m werden wegen der hohen Leistung Piercing-Kontakte (PIN) in beiden Endkappen verbaut.
Attention! For luminaires of length > 1m, piercing contacts (PIN) are installed in both end caps due to the high power.











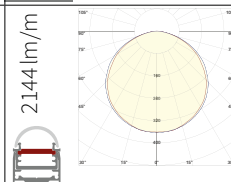
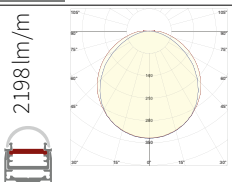
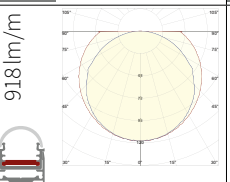

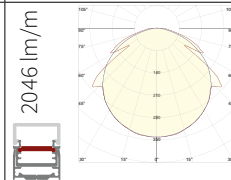
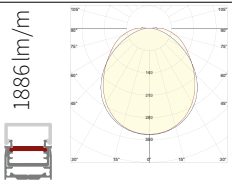
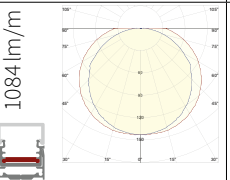
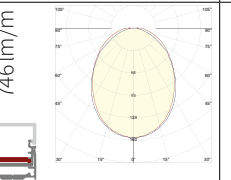

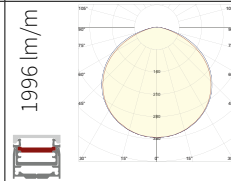
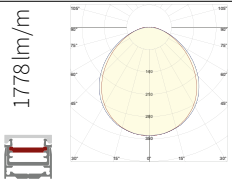
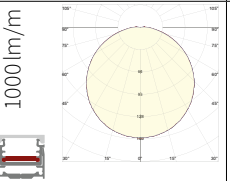

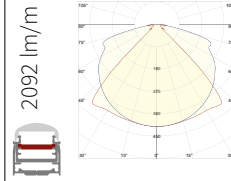
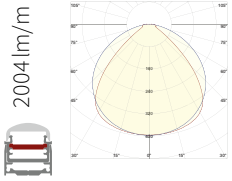

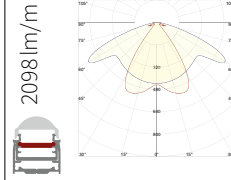
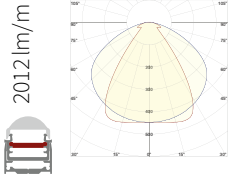
2200 K – Lichtverteilungskurven NP/L2C/G1/09D
 2200 K– light distribution curves NP/L2C/G1/09D

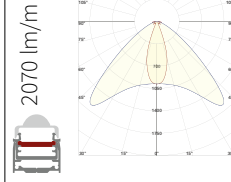
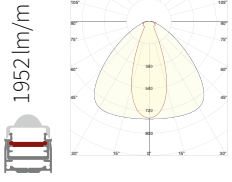
IP40

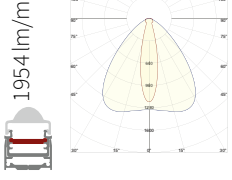
covers & lenses	T	F	W	G	M
cover round 120° 	2292 lm/m 	2244 lm/m 	1374 lm/m 		
cover square 120° 	2264 lm/m 	2140 lm/m 	1386 lm/m 	882 lm/m 	
cover flat 120° 	2024 lm/m 	1872 lm/m 	1394 lm/m 		
lens 90° 	2116 lm/m 	2052 lm/m 			
lens 60° 	2106 lm/m 	2042 lm/m 			
lens 30° 	2100 lm/m 	1994 lm/m 			
lens 15° 		2010 lm/m 			
lens LAF-2 asymmetric 		1908 lm/m 			
lens ILAF asymmetric (IP65) 					
<p>Messwerte unterliegen den typischen Toleranzen. Measured values are subject to the typical tolerances.</p> <p>Alle lichttechnischen Daten – vermessen im FLASHAAR® Lichtlabor – finden Sie unter flashaar.de im Download-Bereich. Alle optischen und elektrischen Daten haben eine Toleranz von +/- 10%. All photometric data – measured in FLASHAAR's light laboratory – available at flashaar.de/en in the download area. All optical and electrical data have a tolerance of +/- 10%.</p> <p>Messdaten für IP65 auf Anfrage. Measurement data for IP65 on request.</p>					<p>EPREL-Daten: 2200-3000 K  2200-4000 K </p>

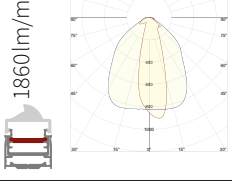





2700 K – Lichtverteilungskurven NP/L2C/G1/09D
 2700 K– light distribution curves NP/L2C/G1/09D

IP40

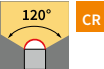
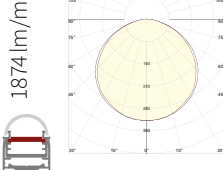
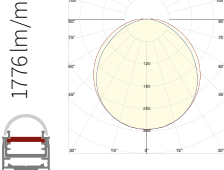
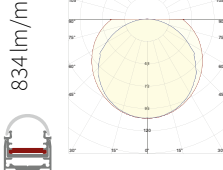
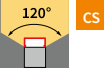
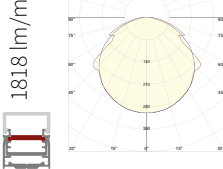
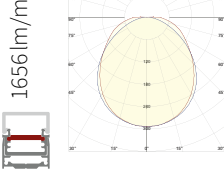
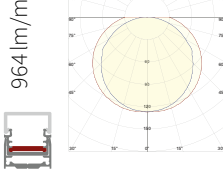
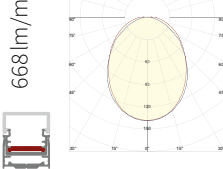
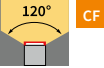
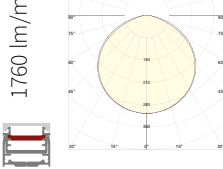
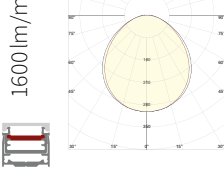
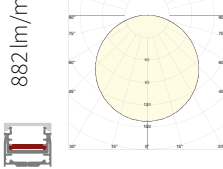
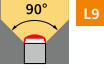
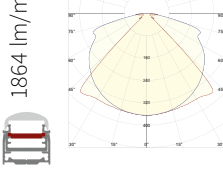
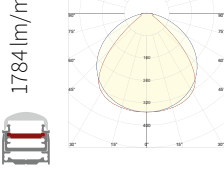
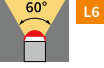
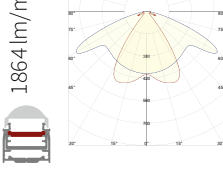
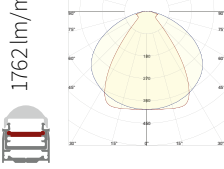
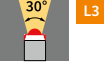
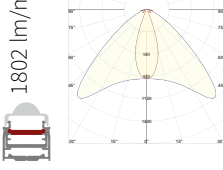
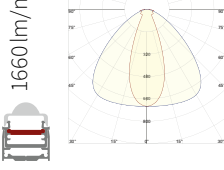
covers & lenses	T	F	W	G	M
cover round 120°  CR	2144 lm/m 	2198 lm/m 	918 lm/m 		
cover square 120°  CS	2046 lm/m 	1886 lm/m 	1084 lm/m 	746 lm/m 	
cover flat 120°  CF	1996 lm/m 	1778 lm/m 	1000 lm/m 		
lens 90°  L9	2092 lm/m 	2004 lm/m 			
lens 60°  L6	2098 lm/m 	2012 lm/m 			
lens 30°  L3	2070 lm/m 	1952 lm/m 			
lens 15°  L1		1954 lm/m 			
lens LAF-2 asymmetric  LA		1860 lm/m 			
lens ILAF asymmetric (IP65)  ILA					
<p>Messwerte unterliegen den typischen Toleranzen. Measured values are subject to the typical tolerances.</p> <p>Alle lichttechnischen Daten – vermessen im FLASHAAR® Lichtlabor – finden Sie unter flashaar.de im Download-Bereich. Alle optischen und elektrischen Daten haben eine Toleranz von +/- 10%. All photometric data – measured in FLASHAAR’s light laboratory – available at flashaar.de/en in the download area. All optical and electrical data have a tolerance of +/- 10%.</p> <p>Messdaten für IP65 auf Anfrage. Measurement data for IP65 on request.</p>					<p>EPREL-Daten: 2700-5600 K</p> 

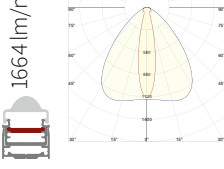

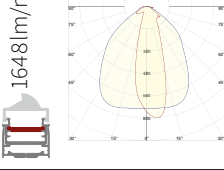







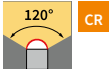
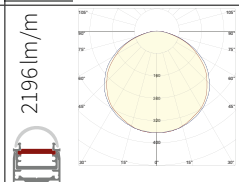
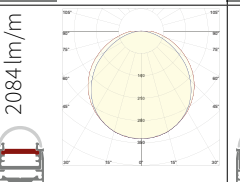
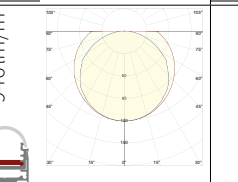

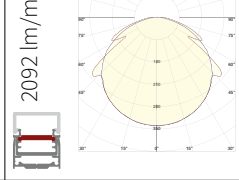
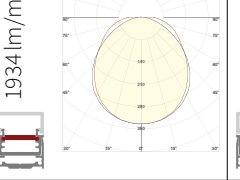
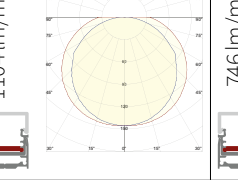
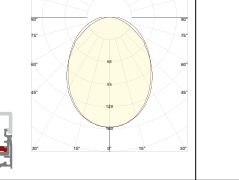

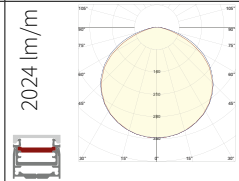
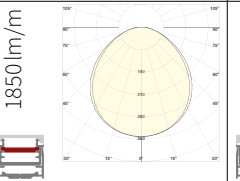
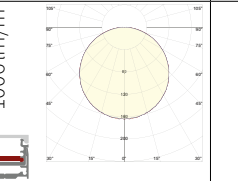
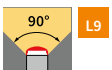
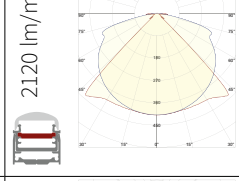
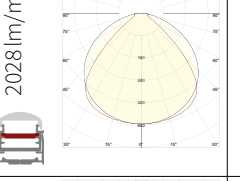
3000 K – Lichtverteilungskurven NP/L2C/G1/09D
 3000 K– light distribution curves NP/L2C/G1/09D

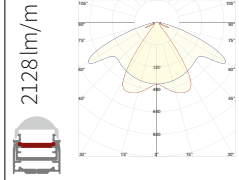
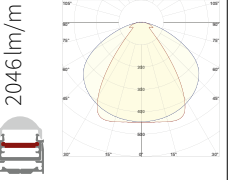
IP40

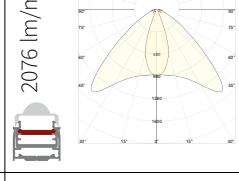
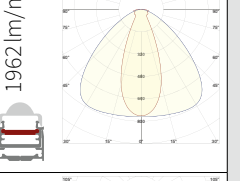
covers & lenses	T	F	W	G	M
cover round 120° 	1874 lm/m 	1776 lm/m 	834 lm/m 		
cover square 120° 	1818 lm/m 	1656 lm/m 	964 lm/m 	668 lm/m 	
cover flat 120° 	1760 lm/m 	1600 lm/m 	882 lm/m 		
lens 90° 	1864 lm/m 	1784 lm/m 			
lens 60° 	1864 lm/m 	1762 lm/m 			
lens 30° 	1802 lm/m 	1660 lm/m 	Messwerte unterliegen den typischen Toleranzen. Measured values are subject to the typical tolerances. Alle lichttechnischen Daten – vermessen im FLASHAAR® Lichtlabor – finden Sie unter flashaar.de im Download-Bereich. Alle optischen und elektrischen Daten haben eine Toleranz von +/- 10%. All photometric data – measured in FLASHAAR's light laboratory – available at flashaar.de/en in the download area. All optical and electrical data have a tolerance of +/- 10%. Messdaten für IP65 auf Anfrage. Measurement data for IP65 on request.		EPREL-Daten: 2200-3000 K 
lens 15° 		1664 lm/m 			
lens LAF-2 asymmetric 		1648 lm/m 			
lens ILAF asymmetric (IP65) 					

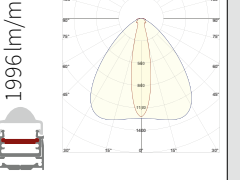

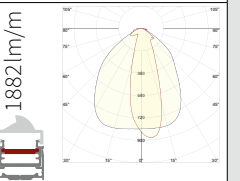
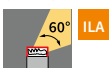







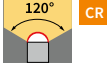

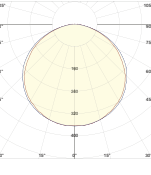

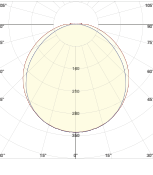

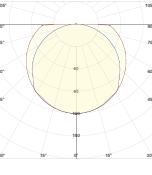
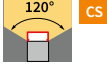

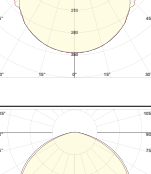

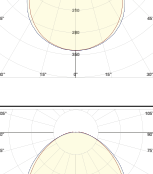

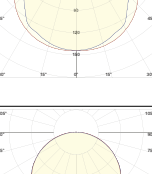

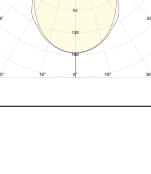
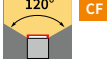

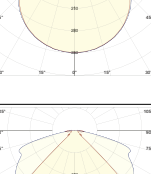

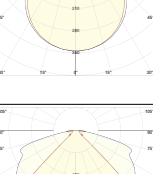

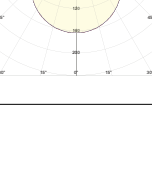
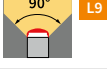

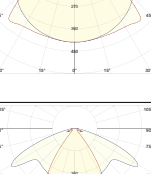

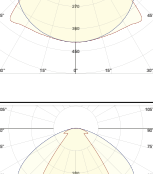

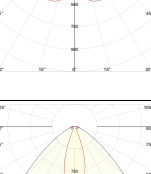

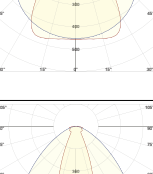

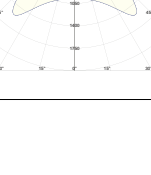
4000 K – Lichtverteilungskurven NP/L2C/G1/09D
 4000 K– light distribution curves NP/L2C/G1/09D

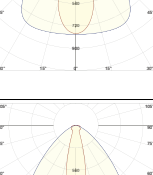
IP40

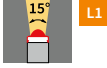
covers & lenses	T	F	W	G	M
cover round 120° 	2196 lm/m 	2084 lm/m 	946 lm/m 		
cover square 120° 	2092 lm/m 	1934 lm/m 	1104 lm/m 	746 lm/m 	
cover flat 120° 	2024 lm/m 	1850 lm/m 	1006 lm/m 		
lens 90° 	2120 lm/m 	2028 lm/m 			
lens 60° 	2128 lm/m 	2046 lm/m 			
lens 30° 	2076 lm/m 	1962 lm/m 			
lens 15° 		1996 lm/m 			
lens LAF-2 asymmetric 		1882 lm/m 			
lens ILAF asymmetric (IP65) 					
<p>Messwerte unterliegen den typischen Toleranzen. Measured values are subject to the typical tolerances.</p> <p>Alle lichttechnischen Daten – vermessen im FLASHAAR® Lichtlabor – finden Sie unter flashaar.de im Download-Bereich. Alle optischen und elektrischen Daten haben eine Toleranz von +/- 10%. All photometric data – measured in FLASHAAR’s light laboratory – available at flashaar.de/en in the download area. All optical and electrical data have a tolerance of +/- 10%.</p> <p>Messdaten für IP65 auf Anfrage. Measurement data for IP65 on request.</p>					<p>EPREL-Daten: 2200-4000 K</p> 

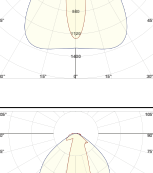
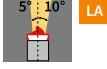
5600 K – Lichtverteilungskurven NP/L2C/G1/09D
 5600 K– light distribution curves NP/L2C/G1/09D

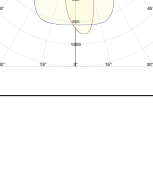
IP40

covers & lenses	T	F	W	G	M
cover round 120° 	2184 lm/m  	2062 lm/m  	940 lm/m  		
cover square 120° 	2096 lm/m  	1926 lm/m  	1078 lm/m  	752 lm/m  	
cover flat 120° 	2038 lm/m  	1852 lm/m  	1006 lm/m  		
lens 90° 	2136 lm/m  	2136 lm/m  			
lens 60° 	2144 lm/m  	2050 lm/m  			
lens 30° 	2066 lm/m  	1974 lm/m  	<p>Messwerte unterliegen den typischen Toleranzen. Measured values are subject to the typical tolerances.</p> <p>Alle lichttechnischen Daten – vermessen im FLASHAAR® Lichtlabor – finden Sie unter flashaar.de im Download-Bereich. Alle optischen und elektrischen Daten haben eine Toleranz von +/- 10%. All photometric data – measured in FLASHAAR's light laboratory – available at flashaar.de/en in the download area. All optical and electrical data have a tolerance of +/- 10%.</p> <p>Messdaten für IP65 auf Anfrage. Measurement data for IP65 on request.</p>		<p>EPREL-Daten: 2700-5600 K</p> 
lens 15° 		1980 lm/m  			
lens LAF-2 asymmetric 		1888 lm/m  			
lens ILAF asymmetric (IP65) 					

Verdrahtungsschema wiring diagrams

Beispiel für max. Länge mit einer elektrischen Einspeisung.*
example for max. length with one electrical feed.*

WD/D/PWM/Pegasus-a (1x2CH)

Dimmbar mittels PWM, System mit 2 Kanälen für NP Pegasus, 24VDC
dimmable by PWM, system with 2 channels for NP Pegasus, 24 VDC
max. **16 m** (2x414 W) pro Einspeisung / max. 16 m (2x414 W) per feed in

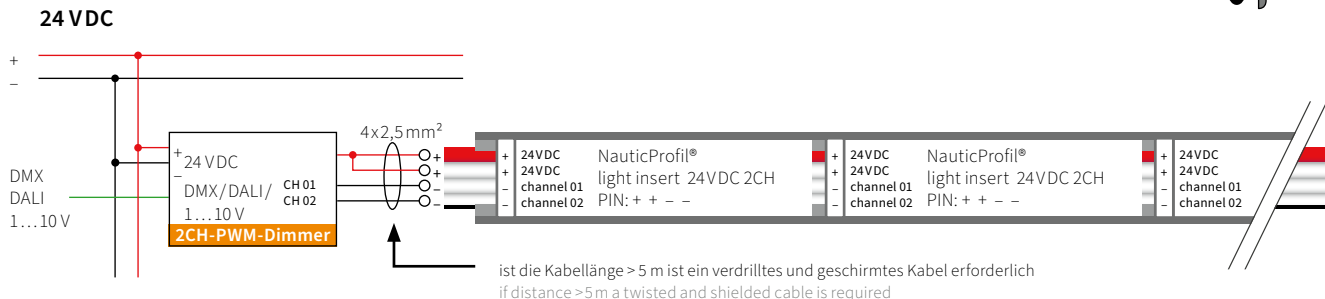
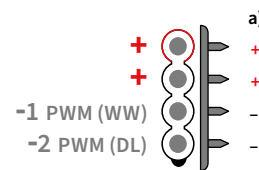

⚠ Bitte beachten: mit dem DALI DT6 16A Dimmer ist entweder der Betrieb beider Kanäle mit 50% Leistung oder alternativ der Betrieb eines Kanals mit 100% Leistung erlaubt!
Please note: when operating with a DALI DT6 16A dimmer, only the operation of both channels at 50% or alternatively the operation of one channel with 100% power is allowed!

WD/S/1a/Pegasus (1x2CH)

Schaltbar, System mit 2 Kanälen / 2CH Leuchteneinsätze Pegasus-4 (z. B. tunable white)
to switch ON/OFF, system with 2 channels / 2CH light insert Pegasus-4
(e.g. tunable white)

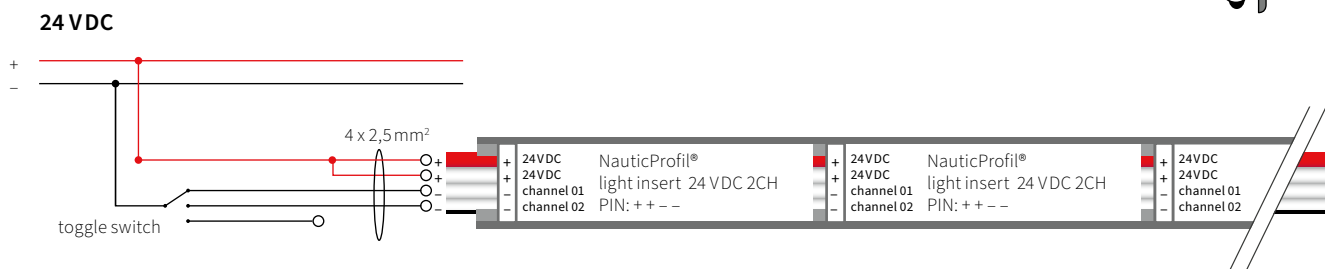
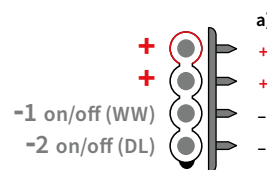

⚠ Achtung! Der Betrieb beider Lichtfarben gleichzeitig auf 100% ist nicht zulässig! Auf ausreichende Kühlung ist zu achten. Max. 24 W/m Gesamtleistung.
Operating both light colours at 100% at the same time is not permitted! Sufficient cooling must be ensured. Maximum total output 24 W/m

* Standard PIN-Belegung ist + - - + (WD/D/PWM/1a) / Weitere Verdrahtungsschemata in unserem aktuellen Katalog.
standard pin layout is + - - + (WD/D/PWM/1a) / further cabling scheme in our current catalogue.



Brückenbeleuchtung in Dordrecht (NL)

Beidseitig montierte, 18 Meter lange LED Leuchten NP Defiant tauchen die Balkenbrücke und Fußgängerbrücke Pelsbrug aus dem Jahre 1874 in ein stimmungsvolles, farbiges Licht.

Bridge lighting in Dordrecht (NL)

NP Defiant 18-metre long LED luminaires mounted on both sides bathe the Pelsbrug girder bridge and footbridge dating from 1874 in atmospheric, coloured light.

NP Defiant



28 m per feed-in (dimmed**) | RGB: 1200 lm/m*

RGB-LEDs schaffen ein individuelles Farbspiel sowie ein erstklassiges RGB-Weiß.

RGB LEDs create an individual play of colours and first-class RGB white.

Effektlicht oder dekorative Anwendungen: Der Leuchteneinsatz **NauticProfil® Defiant** ermöglicht mit seinen RGB-LEDs beeindruckende Farbwechsel sowie ein erstklassiges RGB-Weiß.

Durch die spezielle Geometrie und Anordnung der LEDs kann auch Weiß in hoher Qualität dargestellt werden. Der sehr kleine Punktabstand der RGB-LED ermöglicht ein homogen leuchtendes Cover. Die verwendete LED-Technik garantiert, dass es nicht zum Aufbrechen der Farben in Kombination mit Linearlinsen kommen kann.

Effect light or decorative applications: the **NauticProfil® Line Defiant** light insert with its RGB LEDs makes for impressive colour changes as well as first-class RGB white.

The special geometry and arrangement of the LEDs mean that it is possible to even render high-quality white. The very small dot pitch of the RGB LED allows a homogeneous glowing cover.

The LED technology used guarantees that the colours can not break up in combination with linear lenses.

Stimmungslicht für Zuhause, Hotels und Wellnessbereiche

mood lighting for home, hotels and wellness areas

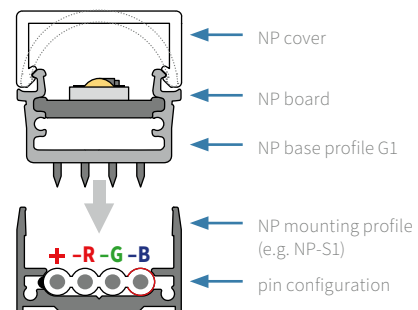
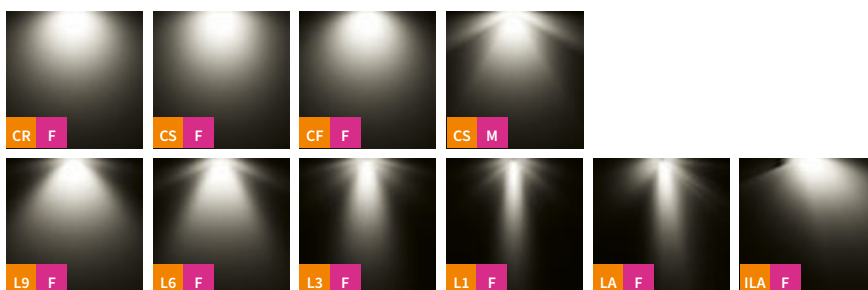

48V DC, 300g, IP40, characteristics

PWM dimmable, dimming

IP65, IK10, RAL optional, optional

mounting



* Alle Angaben zum Lumenstrom beziehen sich auf das Leuchtmedium. In Kombination mit Cover/Linsen kommt es zu materialbedingtem Lichtverlust.
All information about the luminous flux refers to the light source. In combination with covers/lenses it comes to material-related light loss.

** Nur zugelassen für DALI DT8! Only approved for DALI DT8!

Bestellnummer
item number

NP/L3C/G1/22A / L3C/G1/ 112 / G1/ ALA / RGB / CR W

Technische Daten
technical data

nominal voltage: 48VDC
 nominal wattage: 3 x 16,8W/m
 dimmable: PWM
 LED service life: L80/B10 > 75000 h
 length dividing matrix: 100 mm
 LED pitch: 6,64 mm, 150 LEDs/m
 max. length per feed-in: L(max) DIMMED = 28m (500 W/CH*),
 DT8 , 3 x 16A PWM Dimmer, cabling scheme D/PWM/3ab

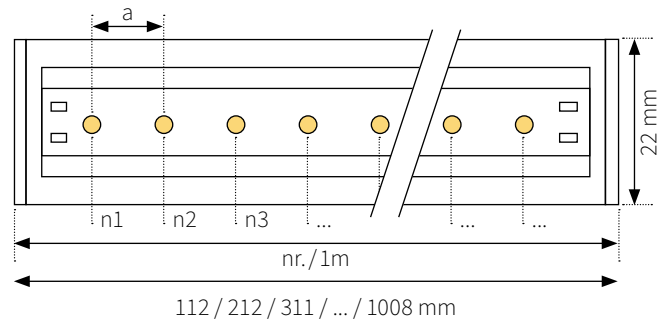

⚠ Achtung! Der Betrieb von RGB gleichzeitig auf 100 % ist nicht zulässig! Auf ausreichende Kühlung ist zu achten.
Max. 24W/m Gesamtleistung (1CH entspricht 16,8 W/m)

Attention! Operating RGB light colours at 100 % at the same time is not permitted! Sufficient cooling must be ensured.
Maximum total output 24 W/m (1CH conform to 16,8 W/m)



⚠ Alle optischen und elektrischen Daten haben eine Toleranz von +/- 10%.
 All optical and electrical data have a tolerance of +/- 10%.

Basisprofil
base profile

Das **Basisprofil G1** ist mit allen NP Montageprofilen von FLASHAAR® per Plug&Play kombinierbar. Es ist in den Farben Aluminium und Schwarz eloxiert erhältlich.
 The **base profile G1** can be combined with all NP mounting profiles from FLASHAAR® by Plug & Play. It is available in the colours aluminium and black anodised.

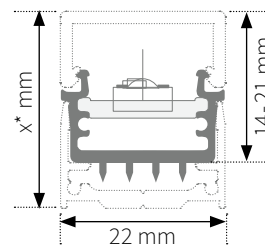

- G1/ALA (Standard)
- G1/BA

* Leuchtenhöhe abhängig vom Montageprofil (21 - 168 mm), Maße ab S. 9
 luminaire height depending on mounting profile (21 - 168 mm), dimensions from p. 9

Lichtwellenlänge und Lumenstrom
light wavelength and luminous flux

	R	G	B
Lichtwellenlänge light wavelength	620 nm	525 nm	470 nm
Lumenstrom typ.* luminous flux typ.*	max. 908 lm/m	max. 2350 lm/m	max. 618 lm/m

* Alle Angaben zum Lumenstrom beziehen sich auf das Leuchtmittel. In Kombination mit Cover/Linsen kommt es zu materialbedingtem Lichtverlust.
 All information about the luminous flux refers to the light source. In combination with covers/lenses it comes to material-related light loss.

IP Schutzklassen
IP protection classes

Je nach Anwendung, gibt es verschiedene Schutzklassen für unsere LED-Leuchteneinsätze. Als Standard bieten wir die Leuchten in **IP40** an. Für die Schutzklasse **IP65** vergießen wir unsere Leuchten mit einem hochwertigen transparenten Polyurethan-Verguss (PU-Verguss) frei von störenden Mikroblasen.

Depending on the application, there are different protection classes for our LED light inserts. As standard, we offer the luminaires in **IP40**. For protection class **IP65**, we cast our luminaires with a high-quality transparent polyurethane encapsulation (PU encapsulation) free of disruptive micro-bubbles.

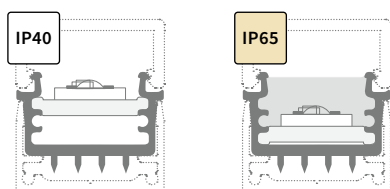

Übersicht Standardlängen & Wattagen

overview standard lengths & wattages

IP40, IP65		
product-nr.	L (mm)	Watt*
NP/L3C/G1/22A/L3C/G1/0112/###/###	112	3x1,68
NP/L3C/G1/22A/L3C/G1/0212/###/###	212	3x3,36
NP/L3C/G1/22A/L3C/G1/0311/###/###	311	3x5,04
NP/L3C/G1/22A/L3C/G1/0411/###/###	411	3x6,72
NP/L3C/G1/22A/L3C/G1/0510/###/###	510	3x8,40

IP40, IP65		
product-nr.	L (mm)	Watt*
NP/L3C/G1/22A/L3C/G1/0610/###/###	610	3x10,08
NP/L3C/G1/22A/L3C/G1/0710/###/###	710	3x11,76
NP/L3C/G1/22A/L3C/G1/0809/###/###	809	3x13,44
NP/L3C/G1/22A/L3C/G1/0909/###/###	909	3x15,12
NP/L3C/G1/22A/L3C/G1/1008/###/###	1008	3x16,80

Achtung! Im Außenbereich (IP65 und IP65 Premium) ist maximal ein Leuchteneinsatz in der Länge von 112mm bis 1008 mm realisierbar. LED-Teilungsraster ist 100mm.
Attention! In outdoor areas (IP65 and IP65 Premium), a maximum of one luminaire insert can be realised in lengths from 112 mm to 1008 mm. The grid uses 100mm increments
 ** Leistungsangaben +/- 10% | performance data +/- 10%

Verdrahtungsschema

wiring diagrams

Beispiel für max. Länge mit einer elektrischen Einspeisung.*
 example for max. length with one electrical feed.*

WD/D/PWM/3ab
 (1x3CH)

Dimmbar mittels PWM, System mit 3 Kanälen, 48 VDC /
 3CH Leuchteneinsätze (z. B. RGB)
 dimmable by PWM, system with 3 channels, 48 VDC /
 3CH light inserts (e.g. RGB)
 max. **28 m** (500 W) pro Einspeisung / max. 28 m (500 W) per feed in

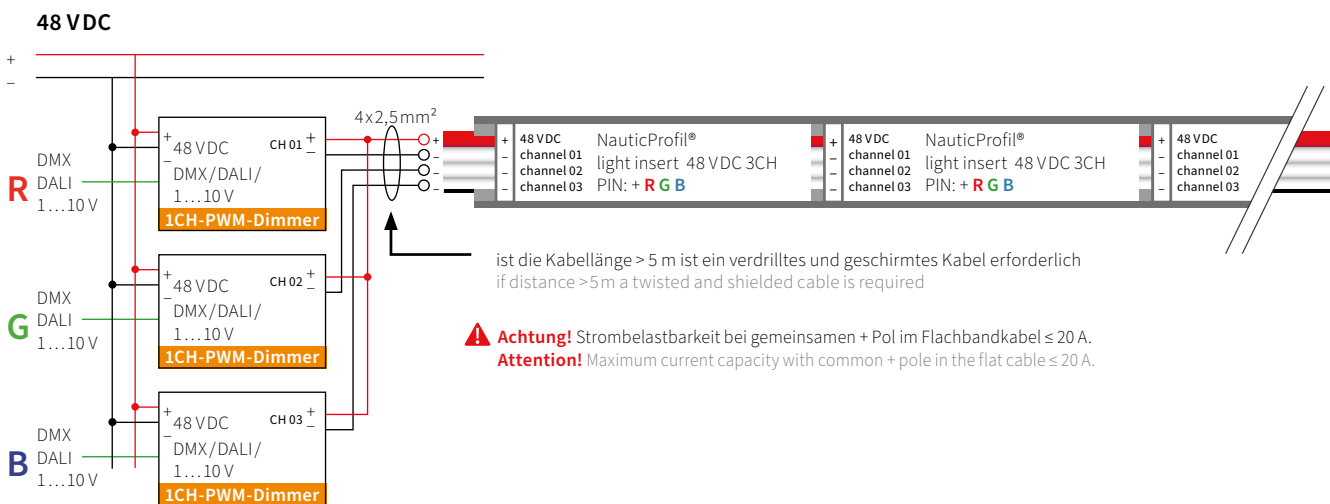
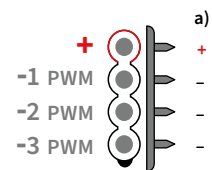





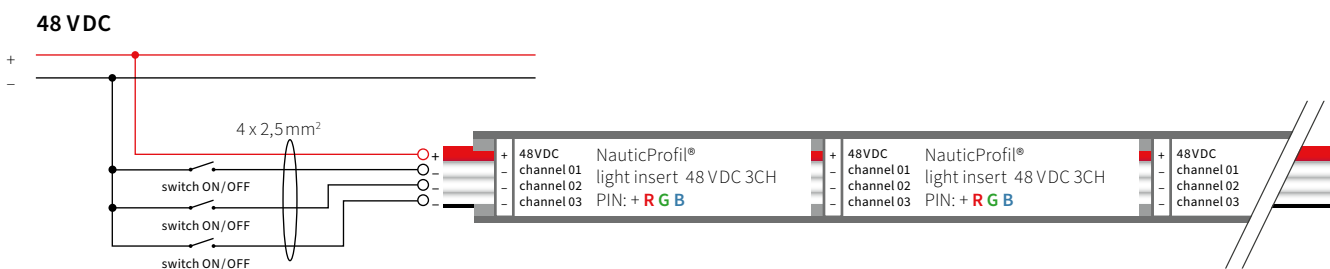
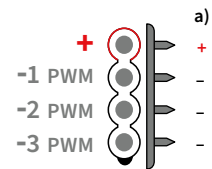



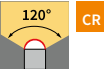
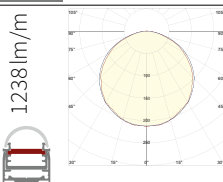
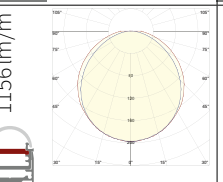
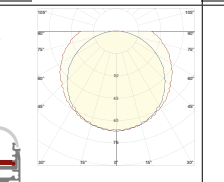
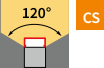
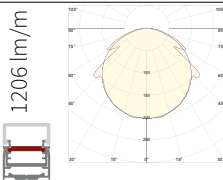
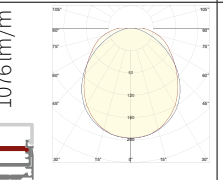
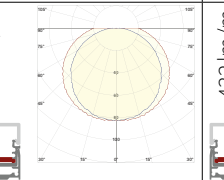
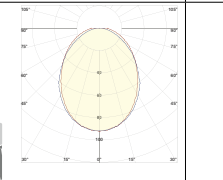
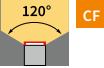
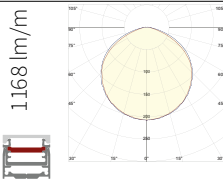
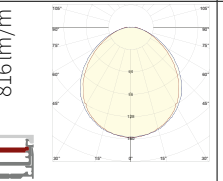
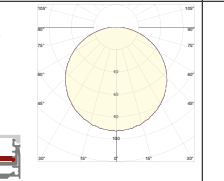
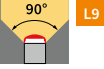
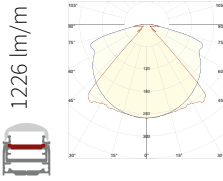
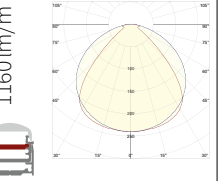
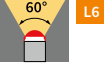
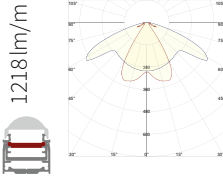
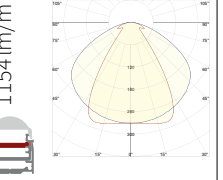
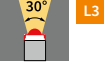
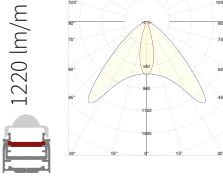
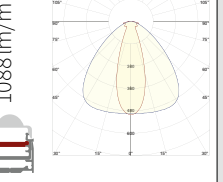

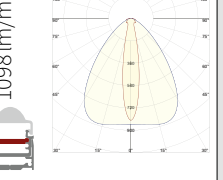
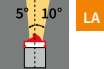
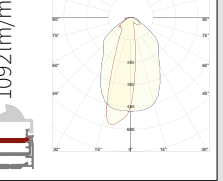

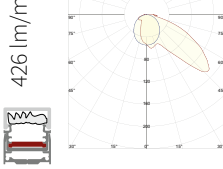



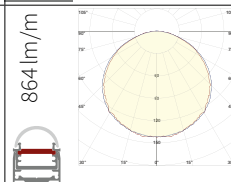
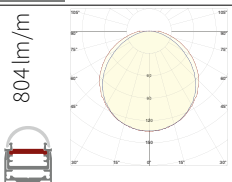
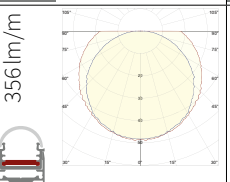

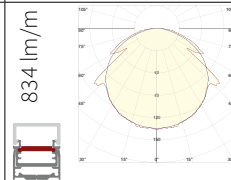
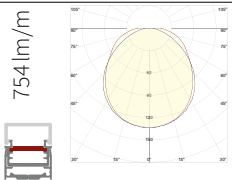
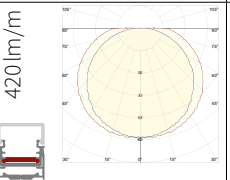
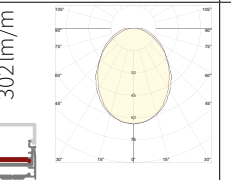

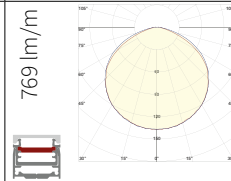
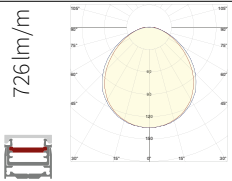
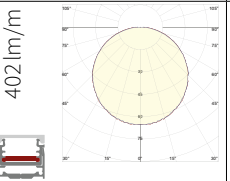

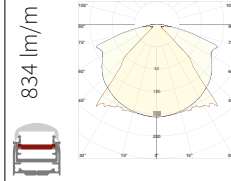
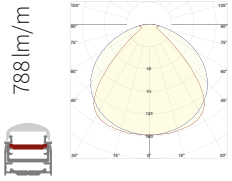
WD/S/1a
 (1x1CH)

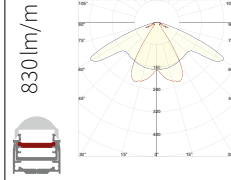
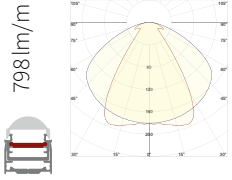

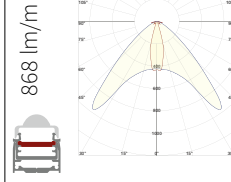
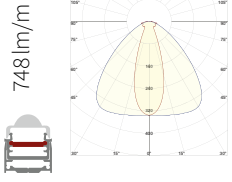

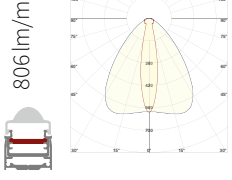

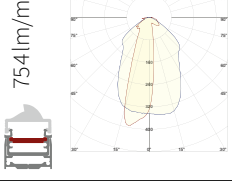

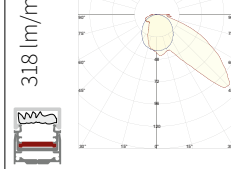

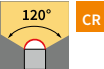

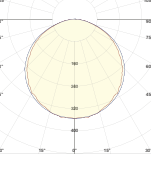

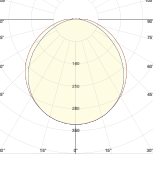

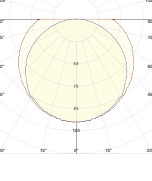
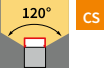

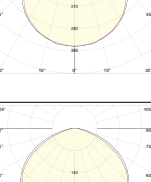

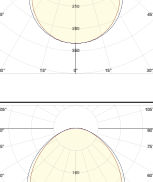

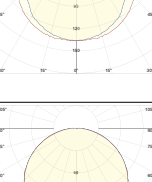

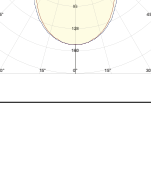
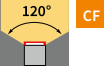

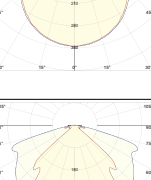

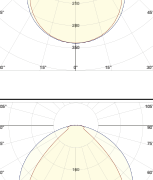

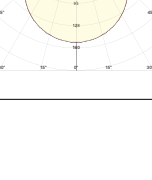
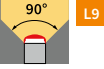

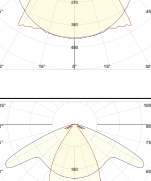

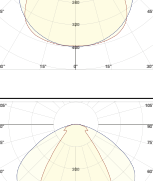
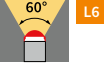

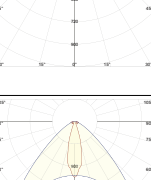

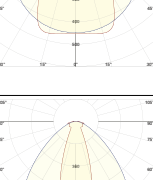
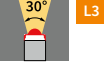
Schaltbar, System mit 1 Kanal /
 1CH Leuchteneinsätze mit redundanter PIN-Belegung
 to switch ON/OFF, system with 1-channel /
 1CH light insert with double PIN connection
 max. **28 m** (500 W) pro Einspeisung / max. 28 m (500 W) per feed in

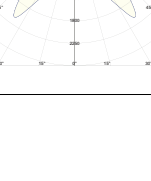

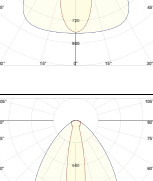

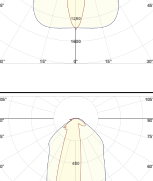

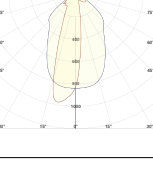

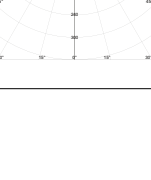

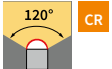
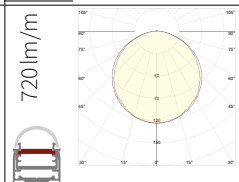
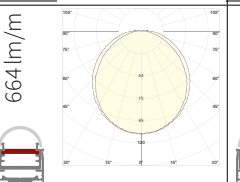
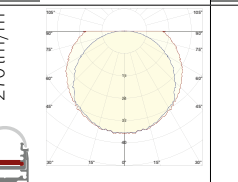

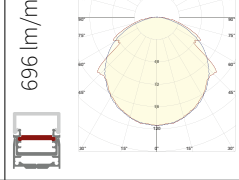
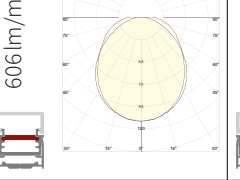
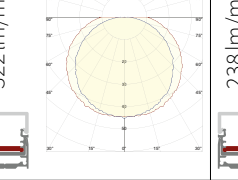
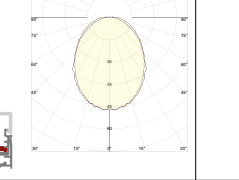
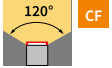
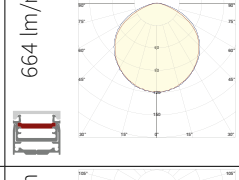
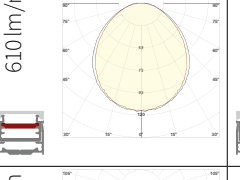
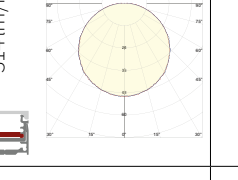
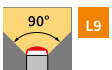
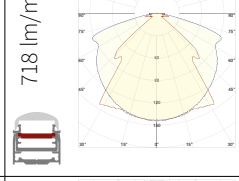
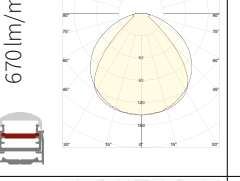
* Standard PIN-Belegung ist + - - + (WD/D/PWM/1a) / Weitere Verdrahtungsschemata in unserem aktuellen Katalog.
 standard pin layout is + - - + (WD/D/PWM/1a) / further cabling scheme in our current catalogue.

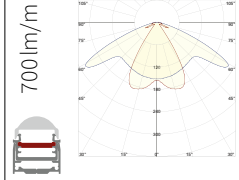
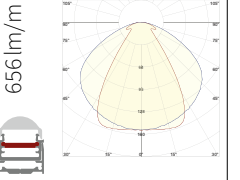
covers & lenses	T	F	W	G	M
cover round 120° 	1238 lm/m 	1156 lm/m 	482 lm/m 		
cover square 120° 	1206 lm/m 	1076 lm/m 	594 lm/m 	432 lm/m 	
cover flat 120° 	1168 lm/m 	816 lm/m 	566 lm/m 		
lens 90° 	1226 lm/m 	1160 lm/m 			
lens 60° 	1218 lm/m 	1154 lm/m 			
lens 30° 	1220 lm/m 	1088 lm/m 			
lens 15° 		1098 lm/m 			
lens LAF-2 asymmetric 		1092 lm/m 			
lens ILAF asymmetric (IP65) 	426 lm/m 				
<p>Messwerte unterliegen den typischen Toleranzen. Measured values are subject to the typical tolerances.</p> <p>Alle lichttechnischen Daten – vermessen im FLASHAAR® Lichtlabor – finden Sie unter flashaar.de im Download-Bereich. Alle optischen und elektrischen Daten haben eine Toleranz von +/- 10%. All photometric data – measured in FLASHAAR's light laboratory – available at flashaar.de/en in the download area. All optical and electrical data have a tolerance of +/- 10%.</p> <p>Messdaten für IP65 auf Anfrage. Measurement data for IP65 on request.</p>					

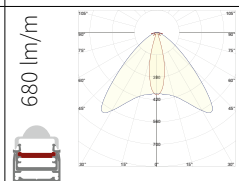
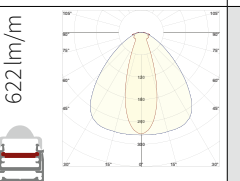
covers & lenses	T	F	W	G	M
cover round 120°  CR	864 lm/m 	804 lm/m 	356 lm/m 		
cover square 120°  CS	834 lm/m 	754 lm/m 	420 lm/m 	302 lm/m 	
cover flat 120°  CF	769 lm/m 	726 lm/m 	402 lm/m 		
lens 90°  L9	834 lm/m 	788 lm/m 			
lens 60°  L6	830 lm/m 	798 lm/m 			
lens 30°  L3	868 lm/m 	748 lm/m 			
lens 15°  L1		806 lm/m 			
lens LAF-2 asymmetric  LA		754 lm/m 			
lens ILAF asymmetric (IP65)  ILA	318 lm/m 				
<p>Messwerte unterliegen den typischen Toleranzen. Measured values are subject to the typical tolerances.</p> <p>Alle lichttechnischen Daten – vermessen im FLASHAAR® Lichtlabor – finden Sie unter flashaar.de im Download-Bereich. Alle optischen und elektrischen Daten haben eine Toleranz von +/- 10%. All photometric data – measured in FLASHAAR’s light laboratory – available at flashaar.de/en in the download area. All optical and electrical data have a tolerance of +/- 10%.</p> <p>Messdaten für IP65 auf Anfrage. Measurement data for IP65 on request.</p>					

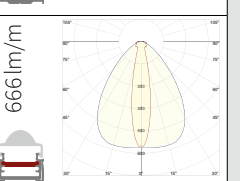
covers & lenses	T	F	W	G	M
cover round 120° 	2074 lm/m  	1944 lm/m  	796 lm/m  		
cover square 120° 	1996 lm/m  	1996 lm/m  	974 lm/m  	704 lm/m  	
cover flat 120° 	1938 lm/m  	1760 lm/m  	944 lm/m  		
lens 90° 	2064 lm/m  	1968 lm/m  			
lens 60° 	2034 lm/m  	1964 lm/m  			
lens 30° 	2056 lm/m  	1804 lm/m  			
lens 15° 		1894 lm/m  			
lens LAF-2 asymmetric 		1818 lm/m  			
lens ILAF asymmetric (IP65) 	778 lm/m  				
<p>Messwerte unterliegen den typischen Toleranzen. Measured values are subject to the typical tolerances.</p> <p>Alle lichttechnischen Daten – vermessen im FLASHAAR® Lichtlabor – finden Sie unter flashaar.de im Download-Bereich. Alle optischen und elektrischen Daten haben eine Toleranz von +/- 10%. All photometric data – measured in FLASHAAR's light laboratory – available at flashaar.de/en in the download area. All optical and electrical data have a tolerance of +/- 10%.</p> <p>Messdaten für IP65 auf Anfrage. Measurement data for IP65 on request.</p>					

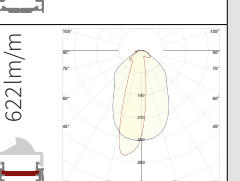
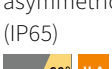
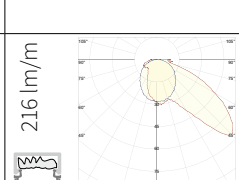
covers & lenses	T	F	W	G	M
cover round 120° 	720 lm/m 	664 lm/m 	270 lm/m 		
cover square 120° 	696 lm/m 	606 lm/m 	322 lm/m 	238 lm/m 	
cover flat 120° 	664 lm/m 	610 lm/m 	314 lm/m 		
lens 90° 	718 lm/m 	670 lm/m 			
lens 60° 	700 lm/m 	656 lm/m 			
lens 30° 	680 lm/m 	622 lm/m 			
lens 15° 		666 lm/m 			
lens LAF-2 asymmetric 		622 lm/m 			
lens ILAF asymmetric (IP65) 	216 lm/m 				
<p>Messwerte unterliegen den typischen Toleranzen. Measured values are subject to the typical tolerances.</p> <p>Alle lichttechnischen Daten – vermessen im FLASHAAR® Lichtlabor – finden Sie unter flashaar.de im Download-Bereich. Alle optischen und elektrischen Daten haben eine Toleranz von +/- 10%. All photometric data – measured in FLASHAAR's light laboratory – available at flashaar.de/en in the download area. All optical and electrical data have a tolerance of +/- 10%.</p> <p>Messdaten für IP65 auf Anfrage. Measurement data for IP65 on request.</p>					

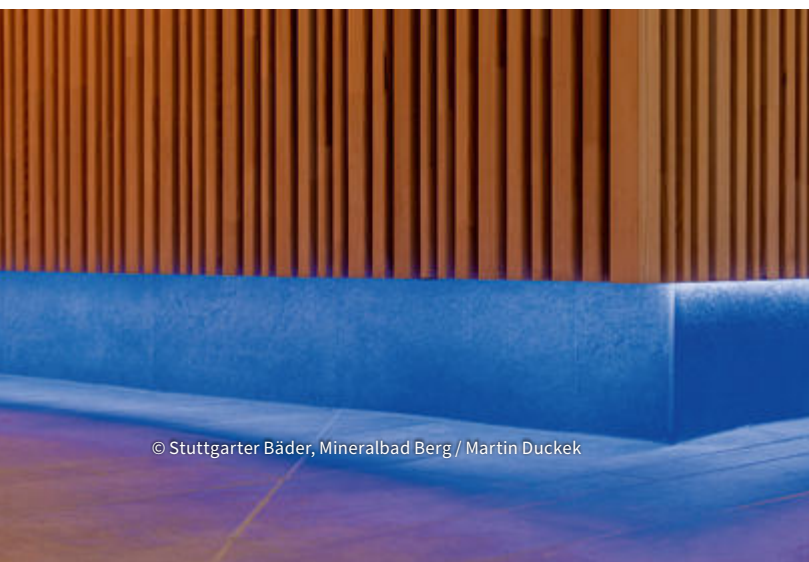

Modernes Bad mit nostalgischem Charme

Das Glasfenster von Max Ackermann im Foyer wird, im Zuge der Sanierung, von FLASHAAR® NP Nova-5, beleuchtet. Versteckt hinter Holzlamellenwänden im Saunabereich, sorgen NP Defiant RGB-Leuchten für ein indirektes, farbiges und harmonisches Stimmunglicht.

Modern bath with nostalgic charm

The glass window by Max Ackermann in the foyer is illuminated by FLASHAAR® NP Nova-5 as part of the renovation. Hidden behind wooden slatted walls in the sauna area, NP Defiant RGB luminaires provide indirect, coloured and harmonious mood lighting.

NP Blind

Hochwertige Profilabdeckung

Als Gestaltungselement in Kombination mit unseren NP Leuchten-einsätzen, auf Gehrung geschnitten als Verblendung für Ecklösungen oder alleinstehend als hochwertiger Kabelkanal:

Unser **NauticProfil® Blind** ist perfekt abgestimmt auf das Nautic-Profil® System. Es sind zwei Versionen verfügbar.

Das quadratische NP Blind passt mit seinen Maßen zu den linearen und den NP Focus Leuchteneinsätzen mit eckigem Cover sowie zum NP PicoSpot. Für NP Leuchteneinsätze mit einer flachen Abdeckung wurde das flache NP Blind mit geringerer Bauhöhe entwickelt. Mit den beiden NP Blind Varianten lassen sich auch Teilbereiche der NP Montageprofile, welche nur das NP Flachkabel enthalten, sauber verblenden.

High-Quality profile cover

As a design element in conjunction with our NP light inserts, mit-tered corner solutions or stand alone as a high quality cable channel: our **NauticProfil® blind insert** has been perfectly coordinated with the NauticProfil® system. Two versions are available.

The square NP Blind with its dimensions matches the linear and NP Focus luminaire inserts with square cover as well as the NP Pi-coSpot. For NP luminaire inserts with a flat cover, the flat NP blind with a lower overall height was developed. With the two NP blind variants, areas of the NP mounting profile which only contains the NP flat cable can be descreately covered.





Bestellnummer item number

Item number	Product	Dimensions	Length (mm)
FLNP/CSB/####/###	NP blind insert square, aluminium	22 x 20 mm	free to choose (max. 2010)
FLNP/CFB/####/###	NP blind insert flat, aluminium	22 x 14,25 mm	free to choose (max. 2010)

↑ ↑ ↑
base length colour
code in mm options

Farboptionen colour options

 .../ALA alu anodized (standard) E6EV1	 .../BA black anodized E6C14	 .../TWP RAL9016 traffic white fine structure (powdered)
--	--	--

Sonderfarben auf Anfrage! Special colours on request!

Beispiel example

FLNP/CSB / 2010 / ALA

Bitte bei Bestellung die Art.-Nr. um die gewünschte Länge und Gehäuseausführung ergänzen.
Please complete the item number with the desired length and housing finish.

Maße ohne NP Montageprofil dimension without NP mounting profile

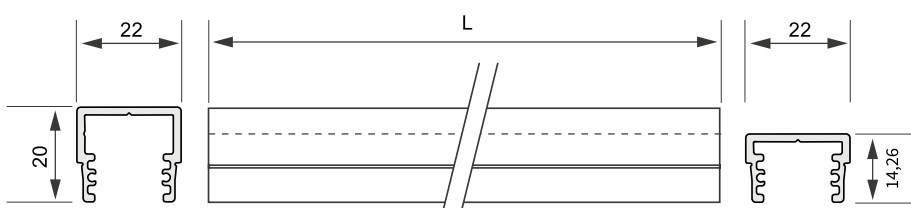

Alle Maßangaben in mm.
All dimensions in mm.



Kesselbergbrücke Mainz

Beidseitig gelangt man barrierefrei über breite Wege und großzügige Treppen hinauf zur Brücke. Für eine funktionale Wegebeleuchtung sorgen LED-Leuchten vom Typ NauticProfil® Victory, die in den Handlauf eingelassen sind. Asymmetrisch gerichtetes Licht leuchtet die Gehwege und Stufen gleichmäßig aus und geleitet Fußgänger und Radfahrer bei Nacht sicher über die Brücke. Die Ausrichtung der Leuchten ist so konzipiert, dass keinerlei Blendung entsteht.

There is barrier-free access to the bridge on both sides via wide paths and generous staircases. NauticProfil® Victory LED luminaires recessed into the handrail provide functional path lighting. Asymmetrically directed light evenly illuminates the walkways and steps, guiding pedestrians and cyclists safely across the bridge at night. The alignment of the luminaires is designed to avoid any glare.





NauticProfil® Focus Leuchteneinsätze

NauticProfil® Focus light inserts

NauticProfil® Focus: High Power LED-Leuchteneinsätze

NauticProfil® Focus: high power LED light inserts

Präzisionslinsen, HighPowerLEDs und ausgefeilte Schaltregler (Focus-4 1CH) — die NauticProfil® Focus Leuchteneinsätze wurden für besonders helle Anwendungen und höchste Ansprüche an die Lichtqualität entwickelt.

Sie sind als 1-Kanal und 4-Kanal Version erhältlich und erfüllen so auch ausgefallene Lichtfarbwünsche.

In Kombination mit 48 Volt Betriebsspannung und unterstromten HighPower LEDs ergeben sich effektive Beleuchtungssysteme mit hoher Betriebssicherheit, geringer Eigenerwärmung und unproblematischer EMV.

Precision lenses, high-power LEDs and sophisticated switching controls (Focus-4 1CH) — the NauticProfil® Focus light inserts have been developed for particularly bright applications and for meeting the highest of demands that are made on the quality of light. They are available as single- and quadruple-channel versions and are therefore also able to fulfil even unusual light-colour requests.

Operating voltages of 48 V and low-current high-power LEDs allow the realisation of effective illumination systems with great operational reliability, low self-heating characteristics and unproblematic EMC properties.

NauticProfil® Focus: Übersicht Leuchteneinsätze

NauticProfil® Focus: overview light inserts

Anzahl an Kanälen number of channels	Focus-4, 1 CH	Focus-3, 4 CH
Lichtfarbe luminous colour	1CH – white or coloured	free to choose
Dimmtyp dimming type	SPWM	PWM CC (350 mA *)
Lichtstrom [lm/m] & Leistung pro Meter [W/m] * luminous flux [lm/m] & power per meter [W/m]		
WW 2200 K (CRI > 80)	typ. 2492 lm/42W	832 lm/max. 12,84 W per channel
WW 2700 K (CRI > 90)	typ. 2740 lm/42W	912 lm/max. 12,84 W per channel
WW 3000 K (CRI > 90)	typ. 2988 lm/42W	996 lm/max. 12,84 W per channel
NW 4000 K (CRI > 80)	typ. 4228 lm/42W	1408 lm/max. 12,84 W per channel
R (620-630 nm)	typ. 2012 lm/34,4W	672 lm/max. 9,12 W per channel
G (520-525 nm)	typ. 3632 lm/48W	1212 lm/max. 13,56 W per channel
B (450-456 nm)	typ. 751 lm/42,4W	250 lm/max. 13,2 W per channel
4Channel: free to choose (e.g. RGBW or tunable white)	—	∑ 4 channels: max. 48,72 W
Elektrische Spezifikation electrical specification		
voltage (DC)	48VDC (36V – 48VDC)	
current (CC)		350 mA *
Maße dimensions		
LED pitch	27,8 mm	20,8 mm (83,3 mm pitch per channel)
LEDs per meter	36	48 (12 per channel)
dividing matrix	250 mm	250 mm
IP Schutzart IP rating (standard/optional)		
	IP40/IP65	IP40 / IP65
Temperaturbereich temperature range [°C]		
	-20...+35	-20...+35

* Je nach Wahl des Montageprofils und Umgebungstemperatur ist eine max. Bestromung der LED/CH von 700 mA möglich.

Auf ausreichende Kühlung ist zu achten! Überhitzung zerstört die LED.

Depending on the choice of mounting profile and ambient temperature, a max. current supply of the LED/CH of 700 mA is possible.

Ensure adequate cooling! Overheating destroys the LED.

NauticProfil® Focus: Übersicht Zubehör & Optionen

NauticProfil® Focus: overview accessories & options

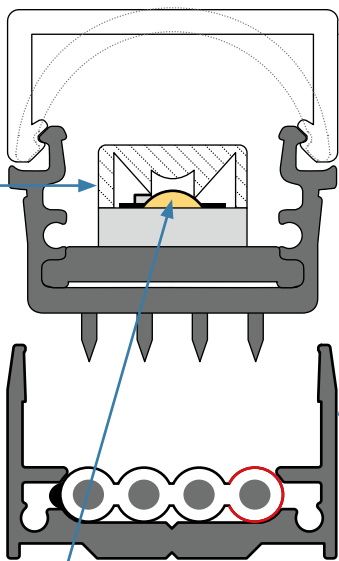
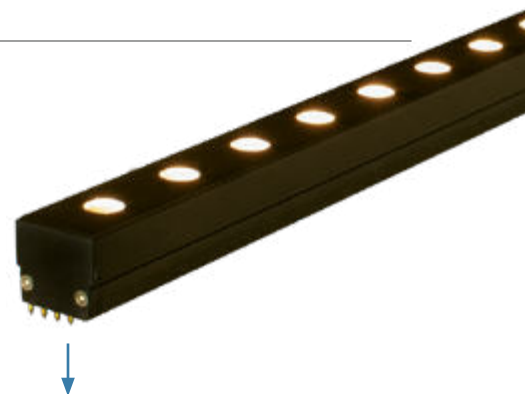

Schutzcover
zwei transparente Standardabdeckungen, rund (CR) und eckig (CS)
protection cover
two transparent protection covers available, round and square

NP Montageprofil
kompatible NP Profile für NP Focus Leuchteneinsätze
NP mounting profiles
compatible NP profiles for NP Focus light inserts

Focus Darklite
mit Aluminiumcover für entblendete Anwendungen im Innenbereich
Focus Darklite
with aluminium cover for glare-free interior applications

HighPowerLED
Extrem lichtstarke LEDs, auch bei farbigem Licht. Mit höchsten Farbwiedergabewerten und einheitlichem Farbort.
LEDs, also for coloured light. With highest colour reproduction values and uniform colour spaces.

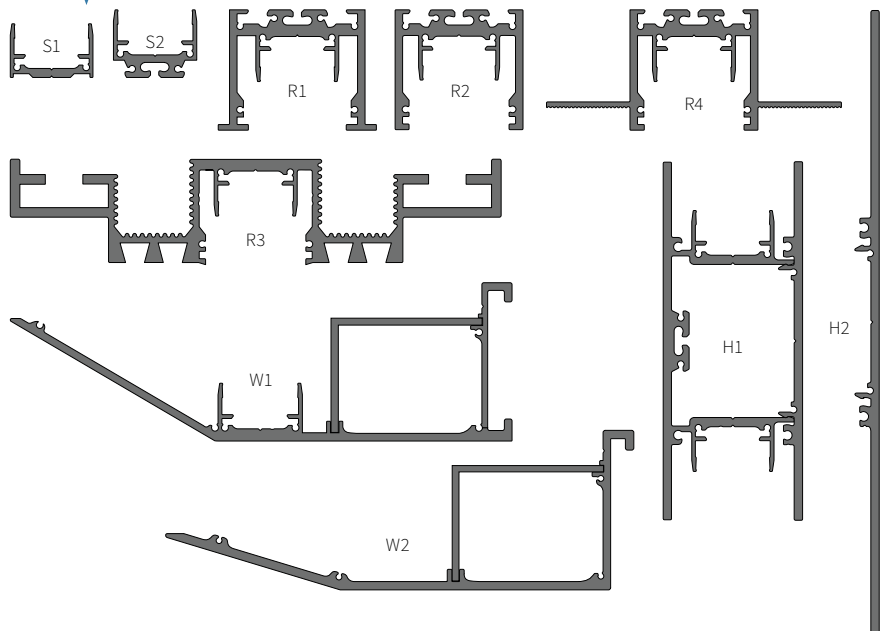

Präzisionslinsen precision lenses

Fünf verschiedene rotationssymmetrische oder elliptische Linsen mit 16°- 36° Ausstrahlungswinkel stehen für die NauticProfil® Focus Leuchteneinsätze zur Auswahl.

Five different rotation-symmetrical or elliptical lenses with 16° to 36° beam angles are available for the NauticProfil® Focus light inserts.

	LSNT/10770	LSNF/10771	LSMF/10772	LSLF/10773	LSOT/10774
Abstrahlungswinkel beamangle	16°	18°	22°	36°	36° x 18°
Bezeichnung description	Precision Lens Symmetric Narrow Transparent 16°	Precision Lens Symmetric Narrow Frosted 18°	Precision Lens Symmetric Medium Frosted 22°	Precision Lens Symmetric Large Frosted 36°	Precision Lens Symmetric Oval Transparent 36° x 18°
Symbolbild symbolic					



Bürgerhaus Herborn

In das NP R1 Montageprofil wurden abwechselnd Leuchtenein-sätze vom Typ NP Nova mit 4000 K und NP Focus mit 3000 K installiert. Auf diese Weise lässt sich das Licht perfekt an unterschiedliche Nutzungen der Räume anpassen.

Herborn Community Centre

In the NP R1 mounting profile, luminaire inserts of the type NP Nova with 4000 K and NP Focus with 3000 K were installed alternately. The light may therefore be perfectly adapted to different room uses.

Vergleich lichttechnischer Merkmale

comparison of lighting characteristics

NauticProfil® Focus



- gezielte Beleuchtung
- hohe Beleuchtungsstärke auf der Beleuchtungsfläche
- kaum Streulicht
- kein Direktlicht an der Decke
- keine betonte Lichtlinie
- perfekte Entblendung ($UGR \leq 19$)
- Targeted lighting
- High illuminance on the lighting surface
- Hardly any diffusion
- No direct light on the ceiling
- No emphasised line of light
- Perfect glare control ($UGR \leq 19$)

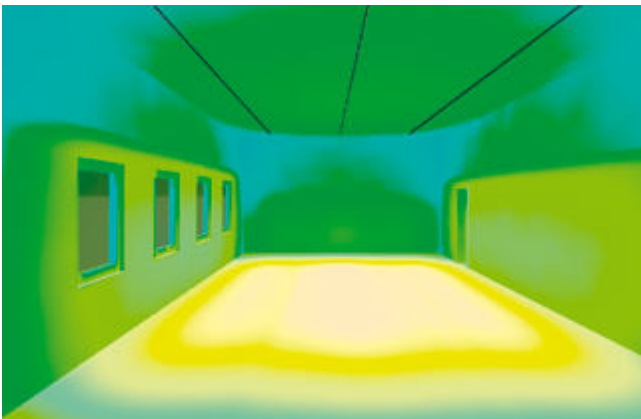

Falschfarbenrendering berechnet mit NP Focus 1Channel (Linse LSLF)
False colour rendering calculated with NP Focus 1Channel (Lens LSLF)

NauticProfil® Line



- weiche, diffuse Beleuchtung
- Helligkeit auf der Fläche, an Wänden und Decke
- hoher Streulichtanteil
- ablesbare Lichtlinien
- perfekt für Kontur- und Akzentlicht
- Soft, diffuse lighting
- Brightness on surfaces, walls and ceilings
- High proportion of diffused light
- Apparent light lines
- Perfect for contour and accent lighting



Falschfarbenrendering berechnet mit NP LINE Nova-4 (Linse L6F)
False colour rendering calculated with NP LINE Nova-4 (Lens L6F)

Angaben Modellberechnung

model calculation information

Projektbeispiel project example			
Raumgröße room size	10x6 m	Raumhöhe ceiling height	3,5 m
Wartungsfaktor maintenance factor	0,8 (EN12464)	Anzahl der Leuchten number of luminaires	3x8 m
Reflexionsgrade reflection factors	70/50/20%	Leuchten luminaires	NP Focus 1CH (LSLF) & NP Line Nova-4 (L6F)

NP Focus-4 1CH

4400 Lumen,
präzise auf den Punkt
4400 lumen
precisely to the point



12 m per feed-in (dimmed) | 4400 lm/m*
CRI > 90 | 2200 K-4000 K



Sonderausführung
in schwarz eloxiert

special version
black anodized

ALA (Standard)

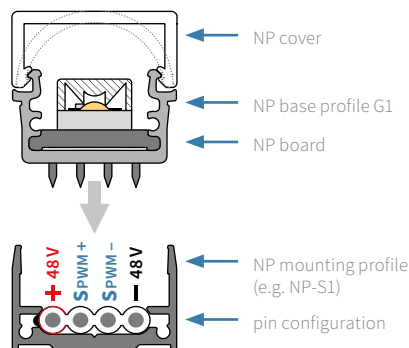
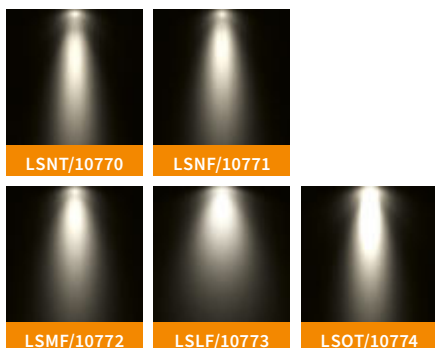

Mit bis zu 4400 lm/m Lichtstrom und Präzisionslinsen über jeder HighPowerLED wird das **NauticProfil® Focus-4 1CH** den hohen Anforderungen an Helligkeit und Lichtverteilung gerecht. Die optimale Wahl auch für Beleuchtungen mit UGR-Vorgaben. 48VDC Betriebsspannung sorgen für hohe Effizienz und Lebensdauer und machen den Leuchteneinsatz NP Focus-4 auch für Verkehrsprojekte und Installationsorte mit weiten Zuleitungen interessant.

Das Dimmen der LEDs erfolgt per SPWM Signal. Eine technische Besonderheit von FLASHAAR®. Der NP Focus-4 1CH Leuchten-einsatz ist alternativ auch mit schwarzem oder transparentem PU-Verguss in der Schutzart IP65 lieferbar.

With a luminous flux of up to 4400 lumen/m and precision lenses on each HighPowerLED, the **NauticProfil® Focus-4 1CH** light insert satisfies the high demands that are made on brightness and light distribution.

It is therefore the optimum choice for lighting that must meet UGR specifications. The operating voltage of 48 V DC ensures high efficiency and long service life and also makes the NP Focus-4 luminaire insert interesting for traffic projects and installation locations with long supply lines. The LEDs are dimmed on the circuit board using an SPWM signal. A special feature of FLASHAAR®. The NP Focus-4 1CH light insert is also available with black or transparent PU-encapsulation, IP65 protection.

48V DC, 416 lm, 20°/35°, IP40
characteristics

SPWM dimmable
dimming

IP65, IK10, RAL optional
optional

mounting options

CE, RoHS, WEEE

* Alle Angaben zum Lumenstrom beziehen sich auf das Leuchtmittel. In Kombination mit Cover/Linsen kommt es zu materialbedingtem Lichtverlust.
All information about the luminous flux refers to the light source. In combination with covers/lenses it comes to material-related light loss.

Bestellnummer
item number

NP/F1C/G1/26D

F1C/G1/ 0258

G1/ ALA

9 27

LSNT/10770

CST

Technische Daten
technical data

nominal voltage: 48VDC (Range: 36 to 48VDC)
 nominal wattage, white: 26W/m (220 mA)
 photometric code: 822/339, 927/339, 930/339, 840/339
 LED service life: L80/B10 > 54000h
 L90/B10 > 54000h (350 mA)
 dimmable: signal pulse width modulation (SPWM)
 length dividing matrix: 250 mm
 LED pitch: 27,75 mm, 36 LEDs/m
 solder jumper: 220, 350, 500, 630 mA (standard 220 mA)
 L(max) DIMMED = 12m (depending on light colour, max. 516W)
 with separately infeeded PWM signal, according to cabling
 scheme D/SPWM/1
 PIN configuration: +48VDC | SPWM+ | SPWM- | -48VDC
 L(max) NOT DIMMED = 39m (depending on light colour,
 max. 1920W). According to cabling scheme S/SPWM/1a.
 PIN configuration: + - - + (48VDC)

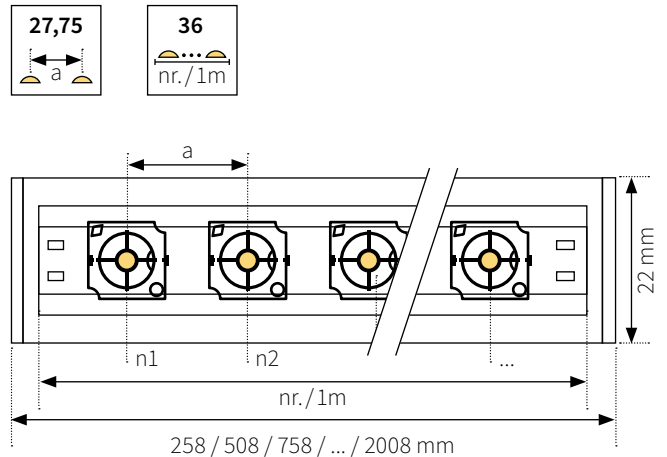

⚠ Alle optischen und elektrischen Daten haben eine Toleranz von +/- 10%.
 All optical and electrical data have a tolerance of +/- 10%.

Farbtemperatur und Lumenstrom
colour temperature and luminous flux

Farbtemperatur colour temperature	WW 2200 K	WW 2700 K	WW 3000 K	NW 4000 K	Red	Green	Blue
CRI typ.	85	93	93	84			
Lumenstrom* 220 mA (Standard) luminous flux* 220 mA (standard)	1688 lm/m	1856 lm/m	2730 lm/m	2864 lm/m	1300 lm/m	2300 lm/m	500 lm/m
Lumenstrom* 350 mA luminous flux* 220 mA	2492 lm/m	2740 lm/m	3616 lm/m	4228 lm/m	2012 lm/m	3632 lm/m	751 lm/m
	822	927	930	840	XXR	XXG	XXB

⚠ **Achten Sie bitte** beim Betrieb der Focus-4 1CH im NP-S1, NP-S2 **auf ausreichend Kühlung!** Im Standard 220 mA auch im NP-S1 und NP-S2 verwendbar.
 While operating the Focus-4 1CH in the NP-S1, NP-S2, ensure there is sufficient cooling! In standard 220 mA also usable in NP-S1 and NP-S2.









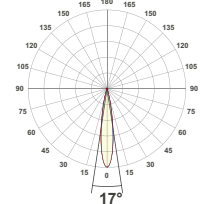

* Alle Angaben zum Lumenstrom beziehen sich auf das Leuchtmittel. In Kombination mit Cover/Linsen kommt es zu materialbedingtem Lichtverlust.
 All information about the luminous flux refers to the light source. In combination with covers/lenses it comes to material-related light loss.

Übersicht Standardlängen & Wattagen
overview standard lengths & wattages

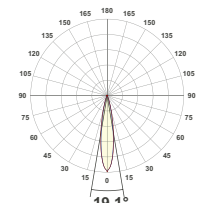
IP40, IP65, IP65 Premium			
product-nr.	L (mm)*	Watt (220 mA)	Watt (350 mA)
NP/F1C/G1/26D/F1C/G1/0258/###/...	0258	6,20	10,60
NP/F1C/G1/26D/F1C/G1/0508/###/...	0508	12,40	21,20
NP/F1C/G1/26D/F1C/G1/0758/###/...	0758	18,60	31,80
NP/F1C/G1/26D/F1C/G1/1008/###/...	1008	24,80	42,40
NP/F1C/G1/26D/F1C/G1/1258/###/...	1258	31,00	53,00
NP/F1C/G1/26D/F1C/G1/1508/###/...	1508	37,20	63,60
NP/F1C/G1/26D/F1C/G1/1758/###/...	1758	43,40	74,20
NP/F1C/G1/26D/F1C/G1/2008/###/...	2008	49,60	84,80

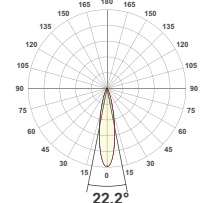
* Länge der Leuchteneinsätze im Innenbereich von 258 mm (10,6W) bis max. 2008 mm (84,8W). Im Außenbereich (IP65) Länge von 258 mm (10,6W) bis max. 1008 mm (42,4W). LED-Teilungsraster ist 250 mm. Bei einer Länge von 1258 mm bis 2008 mm sind Piercings in beiden Stirnseiten erforderlich.
 Light inserts for indoor use from 258 mm (10,6W) up to a maximum length of 2008 mm (84,8W). Outdoor (IP65) length from 256 mm (10,6W) to max. 1008 mm (42,4W). The grid uses 250mm increments. With a length of 1258 to 2008 mm piercings are needed on both ends.

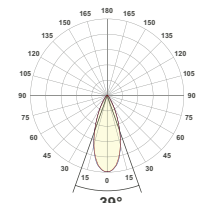
⚠ Piercing beidseitig / double-side piercing

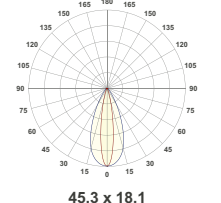
Lichtfarbe/-strom luminous colour/flux	Linsen lenses	Lichtverteilungskurve light distribution curve	
WW 3000 K 2108lm/m CRI 93,3	  <p>precision lens symmetric narrow transparent 16°</p>	 <p>17°</p>	<p>Der Leuchteneinsatz NP Focus-4 1CH ist alternativ auch mit schwarzem oder transparentem PU-Verguss in der Schutzart IP65 lieferbar. The light insert NP Focus-4 1CH is also available with black or transparent PU-encapsulation, IP65 protection.</p>
WW 3000 K 2352lm/m CRI 92,9	  <p>precision lens symmetric narrow frosted 18°</p>	 <p>19,1°</p>	
WW 3000 K 2092lm/m CRI 93,3	  <p>precision lens symmetric medium frosted 22°</p>	 <p>22,2°</p>	<p>Alle Werte in der Tabelle gemessen bei 3000 K mit Cover square transparent. Messwerte unterliegen den typischen Toleranzen. Andere Konfigurationen erhalten Sie auf Anfrage. All values in the table measured at 3000 K with cover square transparent. Measured values are subject to the typical tolerances. Other configurations are available on request.</p>
WW 3000 K 1912lm/m CRI 93,5	  <p>precision lens symmetric large frosted 40°</p>	 <p>39°</p>	<p>Alle lichttechnischen Daten – vermessen im FLAS-HAAR® Lichtlabor – finden Sie unter flashaar.de im Download-Bereich. Alle optischen und elektrischen Daten haben eine Toleranz von +/- 10%.</p>
WW 3000 K 2140lm/m CRI 93,3	  <p>precision lens symmetric oval transparent 42° x 18°</p>	 <p>45,3 x 18,1</p>	<p>All photometric data – measured in FLASHAAR's light laboratory – available at flashaar.de/en in the download area. All optical and electrical data have a tolerance of +/- 10%.</p> <p>Messdaten für IP65 auf Anfrage. Measurement data for IP65 on request.</p>



EPREL-Daten:













2700 K

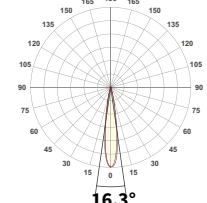

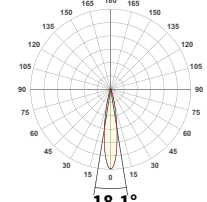
3000 K

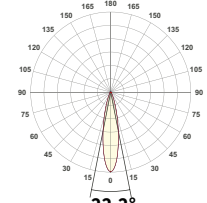

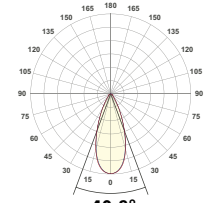
4000 K

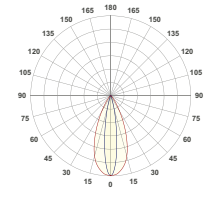
Lichtfarbe/-strom luminous colour/flux	Linsen lenses	Lichtverteilungskurve light distribution curve	
WW 2700 K 3024 lm/m CRI 92,9	  precision lens symmetric narrow transparent 16°	 16,3°	Der Leuchteneinsatz NP Focus-4 1CH ist alternativ auch mit schwarzem oder transparentem PU-Verguss in der Schutzart IP65 lieferbar. The light insert NP Focus-4 1CH is also available with black or transparent PU-encapsulation, IP65 protection.
WW 2700 K 2960 lm/m CRI 92,7	  precision lens symmetric narrow frosted 18°	 18,1°	
WW 2700 K 2864 lm/m CRI 93,1	  precision lens symmetric medium frosted 22°	 22,2°	
WW 2700 K 2652 lm/m CRI 93,4	  precision lens symmetric large frosted 40°	 40,8°	
WW 2700 K 2844 lm/m CRI 93,2	  precision lens symmetric oval transparent 42° x 18°	 45,6° x 19,6°	

— 0/180°
— 90/270°

EPREL-Daten:



2700 K



3000 K



4000 K

Linsen lenses



precision lens
symmetric
narrow transparent
16°



precision lens
symmetric
narrow frosted
18°



precision lens
symmetric
medium frosted
22°



precision lens
symmetric
large frosted
40°



precision lens
symmetric
oval transparent
42° x 18°

Cover/Farbe cover/colour

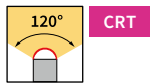

cover round
transparent

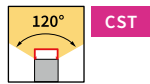

cover square
transparent

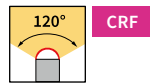

cover round
frosted

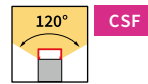

cover square
frosted

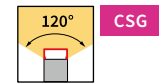

cover square
grey

Verdrahtungsschemata wiring diagrams

Beispiel für max. Länge mit einer elektrischen Einspeisung*
example for max. length with one electrical feed*

D/SPWM/1a (1x1CH)

Dimmbar über SPWM, System mit 1 Kanal, 48VDC /
1CH Leuchteneinsatz / Dimmart: Steuerungs-PWM (SPWM)
dimmable via SPWM, 48VDC single channel system /
1CH light insert (monochrome) / dimming: Signal-PWM
+SPWM short to: -SPWM / -48 V / GND=ON; +SPWM open or short to +48V=OFF

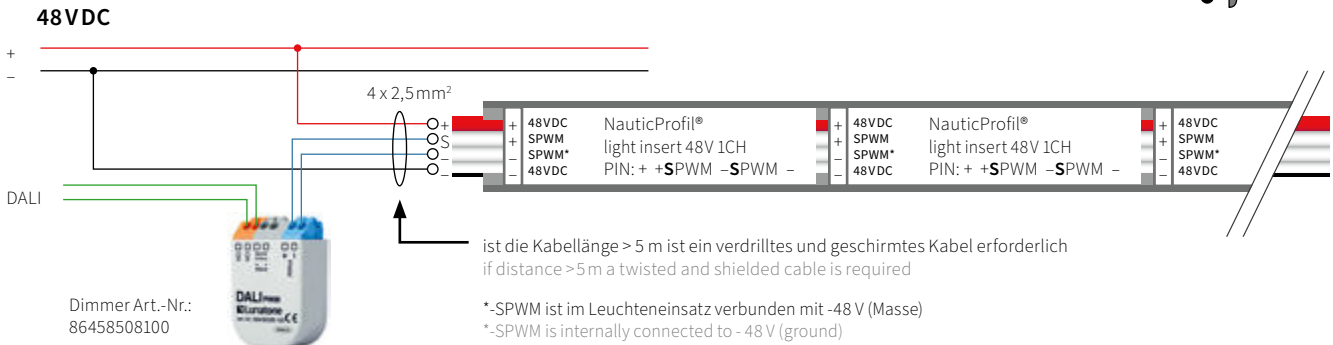
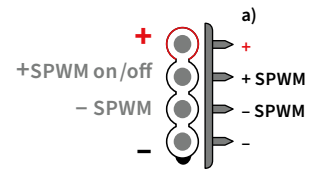

D/SPWM/1b (1x1CH)

Dimmbar über SPWM, System mit 1 Kanal, 48VDC /
1CH Leuchteneinsatz / Dimmart: Steuerungs-PWM (SPWM)
dimmable via SPWM, 48VDC single channel system /
1CH light insert (monochrome) / dimming: Signal-PWM
+SPWM short to: -SPWM / -48 V / GND=ON; +SPWM open or short to +48V=OFF

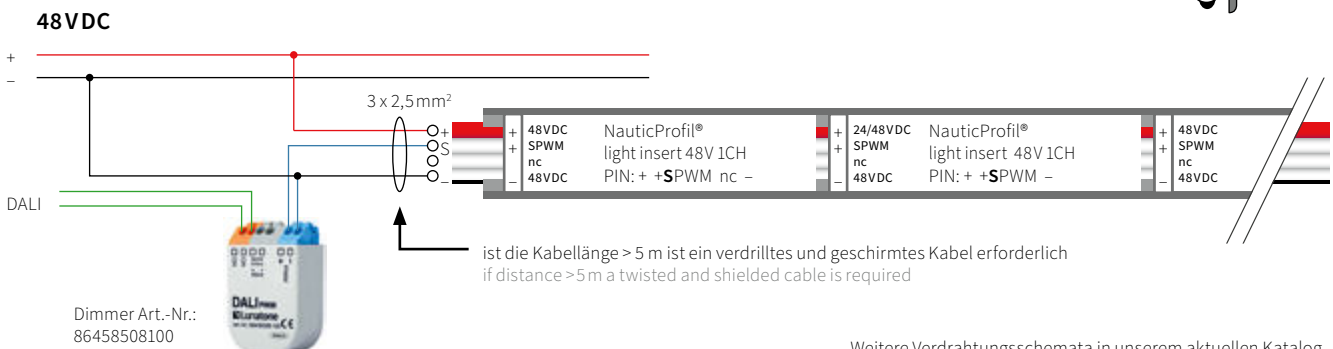
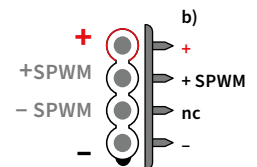

Weitere Verdrahtungsschemata in unserem aktuellen Katalog
further cabling scheme in our current catalogue



Deutsches Romantik-Museum

In der Eingangshalle des Romantik-Museums tauchen NauticProfil® Linien vom Typ Radiant die imposante historische Brandwand in ein warmes Licht. Direkt gegenüber befindet sich eine Bücherwand mit zahlreichen Sammlerstücke, die durch LED Linien in den Deckenvouten gleichmäßig ausgeleuchtet werden. Ein weiteres Highlight des Museums ist schon von außen erkennbar: der mosaikartig verglaste Erker. In ein tiefes Blau getaucht bringen ihn vertikal verbaute FLASHAAR® LED-Linien nachts zum Leuchten.

In the entrance hall of the Romantic Museum, NauticProfil® lines of the Radiant type bathe the imposing historic firewall in a warm light. Directly opposite is a wall of books with numerous collector's items that are uniformly illuminated by LED lines in the ceiling coves. Another highlight of the museum is already visible from the outside: the mosaic-like glazed bay window. Bathed in a deep blue, vertically installed FLASHAAR® LED lines make it glow at night.

NP Focus-4 1CH Darklight

Licht ohne Blendung
Light without glare



15 m per feed-in (dimmed) | 4400 lm/m*
CRI > 90 | 2200 K-4000 K + RGB

Der Leuchteneinsatz **NauticProfil® Focus-4 1CH Darklight** verfügt über die gleichen Präzisionslinsen und High Power LEDs wie die Standardversion, ist aber zusätzlich mit einem Aluminiumcover zur bestmöglichen Endblendung ausgestattet.

Die gesamte Helligkeit ist nur auf der Beleuchtungsfläche wahrnehmbar, während die nahezu blendfreie Leuchte zum edlen und hochwertigen Blickfang an der Decke wird. Unsere NP Focus-4 1CH Darklight ist optional auch mit einem Schutzglas für die Linsen lieferbar.

The light insert **NauticProfil® Focus-4 1CH Darklight** comes with the same precision lenses and high-power LEDs as the standard version but equipped with an additional aluminium cover to provide the best possible protection against glare. Because the entire brightness is only visible on the illuminated area, the luminaire becomes an almost glare-free luminaire that is a noble high-quality eye-catching ceiling fixture.

Our NP Focus-4 1CH Darklight is also optionally available with a protective glass for the lenses.



edler Blickfang, mit nahezu blendfreiem Licht

noble eye-catcher, with almost glare-free light



ALA (Standard)

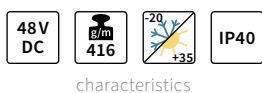
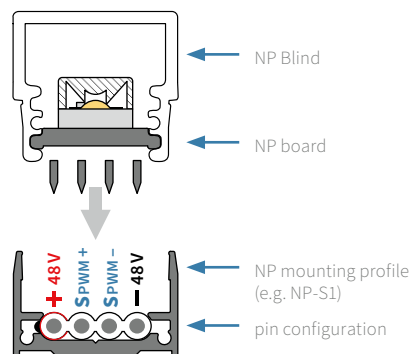
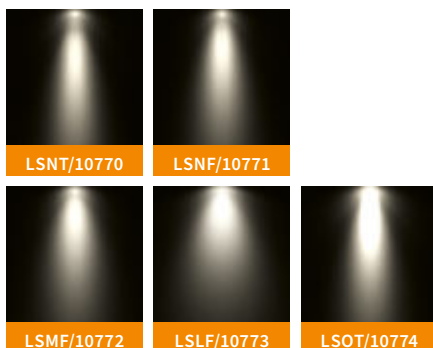

characteristics



dimming

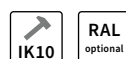

optional



mounting



* Alle Angaben zum Lumenstrom beziehen sich auf das Leuchtmittel. In Kombination mit Cover/Linsen kommt es zu materialbedingtem Lichtverlust.
All information about the luminous flux refers to the light source. In combination with covers/lenses it comes to material-related light loss.

Bestellnummer
item number

NP/DL/F1C/G1/26D

/ DL/F1C/G1/ 0258

/ G1/ ALA

/ 9 27

/ LSNT/10770 BA

Technische Daten technical data

nominal voltage: 48VDC (Range: 36 to 48VDC)
 nominal wattage, white: 42,4W/m (350 mA)
 photometric code: 822/339, 927/339, 930/339, 840/339
 LED service life: L80/B10 > 54000h
 L90/B10 > 54000h
 dimmable: signal pulse width modulation (SPWM)
 length dividing matrix: 250 mm
 LED pitch: 27,75 mm, 36 LEDs/m
 L(max) DIMMED = 15m (depending on light colour, max. 654W)
 with separately infeeded PWM signal, according to cabling
 scheme D/SPWM/1
 PIN configuration: +48VDC | SPWM+ | SPWM- | -48VDC
 L(max) NOT DIMMED = 39m (depending on light colour,
 max. 1920W). According to cabling scheme S/SPWM/1a.
 PIN configuration: + - + (48VDC)

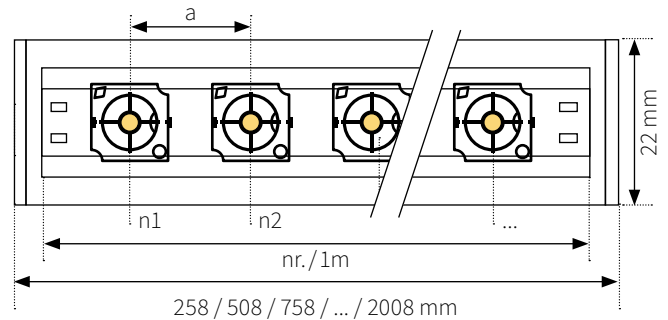

⚠ Alle optischen und elektrischen Daten haben eine Toleranz von +/- 10%.
 All optical and electrical data have a tolerance of +/- 10%.

Farbtemperatur und Lumenstrom colour temperature and luminous flux

(350 mA)

	WW 2200 K	WW 2700 K	WW 3000 K	NW 4000 K	Red	Green	Blue
Farbtemperatur colour temperature	WW 2200 K	WW 2700 K	WW 3000 K	NW 4000 K	Red	Green	Blue
CRI typ.	85	93	93	85			
Lumenstrom* 350 mA luminous flux* 350 mA	2492lm/m	2740lm/m	2988lm/m	4228lm/m	2012lm/m	3632lm/m	751lm/m
	822	927	930	840	XXR	XXG	XXB

* Alle Angaben zum Lumenstrom beziehen sich auf das Leuchtmittel. In Kombination mit Cover/Linsen kommt es zu materialbedingtem Lichtverlust.
 All information about the luminous flux refers to the light source. In combination with covers/lenses it comes to material-related light loss.









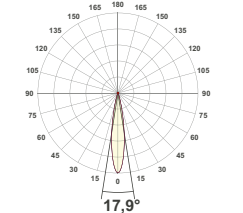

Übersicht Standardlängen & Wattagen overview standard lengths & wattages

(350 mA)

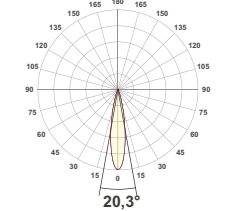
IP40, IP65, IP65 Premium		
product-nr.	L (mm)*	Watt (350 mA)
NP/DL/F1C/G1/26D/DL/F1C/G1/0258/###/...	0253	10,60
NP/DL/F1C/G1/26D/DL/F1C/G1/0508/###/...	0503	21,20
NP/DL/F1C/G1/26D/DL/F1C/G1/0758/###/...	0753	31,80
NP/DL/F1C/G1/26D/DL/F1C/G1/1008/###/...	1003	42,40
NP/DL/F1C/G1/26D/DL/F1C/G1/1258/###/...	1253	53,00
NP/DL/F1C/G1/26D/DL/F1C/G1/1508/###/...	1503	63,60
NP/DL/F1C/G1/26D/DL/F1C/G1/1758/###/...	1753	74,20
NP/DL/F1C/G1/26D/DL/F1C/G1/2008/###/...	2003	84,80

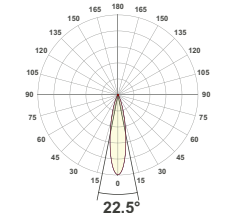
* Länge der Leuchteneinsätze im Innenbereich von 258 mm (10,6W) bis max. 2008 mm (84,8W). LED-Teilungsraster ist 250 mm. Bei einer Länge von 1258 mm bis 2008 mm sind Piercings in beiden Stirnseiten erforderlich.
 Light inserts for indoor use from 258 mm (10,6W) up to a maximum length of 2008 mm (84,8W). The grid uses 250mm increments. With a length of 1258 to 2008 mm piercings are needed on both ends.

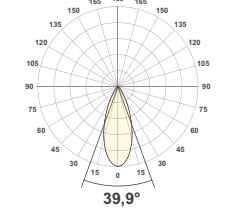
⚠ Piercing beidseitig/double-side piercing

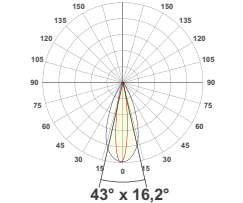
Lichtfarbe/-strom luminous colour/flux	Linsen lenses	Lichtverteilungskurve light distribution curve	
WW 3000 K 3024 lm/m CRI 92,9	  <p>precision lens symmetric narrow transparent 16°</p>	 <p>17,9°</p>	Der Leuchteneinsatz NP Focus-4 1CH Darklight ist optional auch mit einem Schutzglas für die Linsen lieferbar. The light insert NP Focus-4 1CH Darklight is also optionally available with a protective glass for the lenses.
WW 3000 K 2960 lm/m CRI 92,7	  <p>precision lens symmetric narrow frosted 18°</p>	 <p>20,3°</p>	
WW 3000 K 2864 lm/m CRI 93,1	  <p>precision lens symmetric medium frosted 22°</p>	 <p>22,5°</p>	Alle Werte in der Tabelle gemessen bei 3000 K mit Cover square transparent. Messwerte unterliegen den typischen Toleranzen. Andere Konfigurationen erhalten Sie auf Anfrage. All values in the table measured at 3000 K with cover square transparent. Measured values are subject to the typical tolerances. Other configurations are available on request.
WW 3000 K 2652 lm/m CRI 93,4	  <p>precision lens symmetric large frosted 40°</p>	 <p>39,9°</p>	Alle lichttechnischen Daten – vermessen im FLAS-HAAR® Lichtlabor – finden Sie unter flashaar.de im Download-Bereich. Alle optischen und elektrischen Daten haben eine Toleranz von +/- 10%. All photometric data – measured in FLASHAAR's light laboratory – available at flashaar.de/en in the download area. All optical and electrical data have a tolerance of +/- 10%.
WW 3000 K 2844 lm/m CRI 93,2	  <p>precision lens symmetric oval transparent 42° x 18°</p>	 <p>43° x 16,2°</p>	Messdaten für IP65 auf Anfrage. Measurement data for IP65 on request.

— 0/180°
— 90/270°

UGR < 19 

Linsen lenses



precision lens
symmetric
narrow transparent
16°



precision lens
symmetric
narrow frosted
18°



precision lens
symmetric
medium frosted
22°



precision lens
symmetric
large frosted
40°

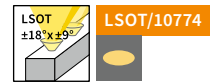

precision lens
symmetric
oval transparent
42° x 18°

Gehäusefarben* housing colours*

Die Focus-4 1CH Darklight ist wahlweise in folgenden Gehäusefarben erhältlich:
The Focus-4 1CH Darklight is available in the following housing colours:



alu anodized (standard)
E6E1



black anodized
E6C14



RAL9016 traffic white
fine structure (powdered)

* Beachten Sie bitte bei der Planung / Bestellung der ergänzenden Montageprofile eine passende Farbe.
When planning/ordering the supplementary mounting profiles, please make sure you choose a suitable colour.

Verdrahtungsschemata wiring diagrams

Beispiel für max. Länge mit einer elektrischen Einspeisung*
example for max. length with one electrical feed*

D/SPWM/1a (1x1CH)

Dimmbar über SPWM, System mit 1 Kanal, 48VDC /
1CH Leuchteneinsatz / Dimmart: Steuerungs-PWM (SPWM)
dimmable via SPWM, 48VDC single channel system /
1CH light insert (monochrome) / dimming: Signal-PWM
+SPWM short to: -SPWM / -48 V / GND=ON; +SPWM open or short to +48V=OFF

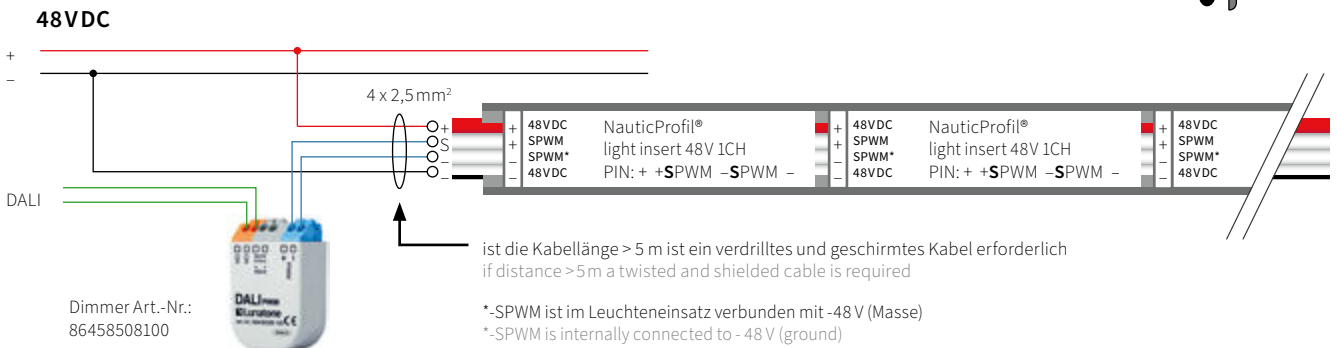
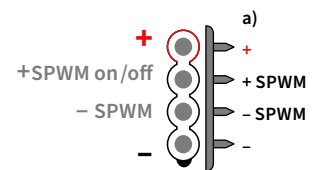

D/SPWM/1b (1x1CH)

Dimmbar über SPWM, System mit 1 Kanal, 48VDC /
1CH Leuchteneinsatz / Dimmart: Steuerungs-PWM (SPWM)
dimmable via SPWM, 48VDC single channel system /
1CH light insert (monochrome) / dimming: Signal-PWM
+SPWM short to: -SPWM / -48 V / GND=ON; +SPWM open or short to +48V=OFF

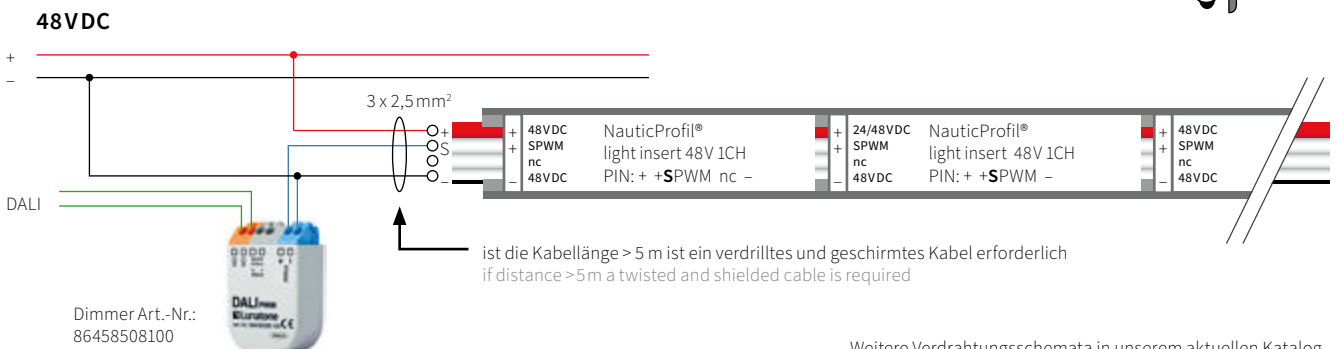
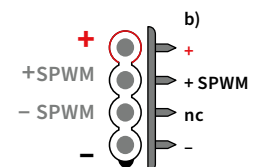

Weitere Verdrahtungsschemata in unserem aktuellen Katalog
further cabling scheme in our current catalogue

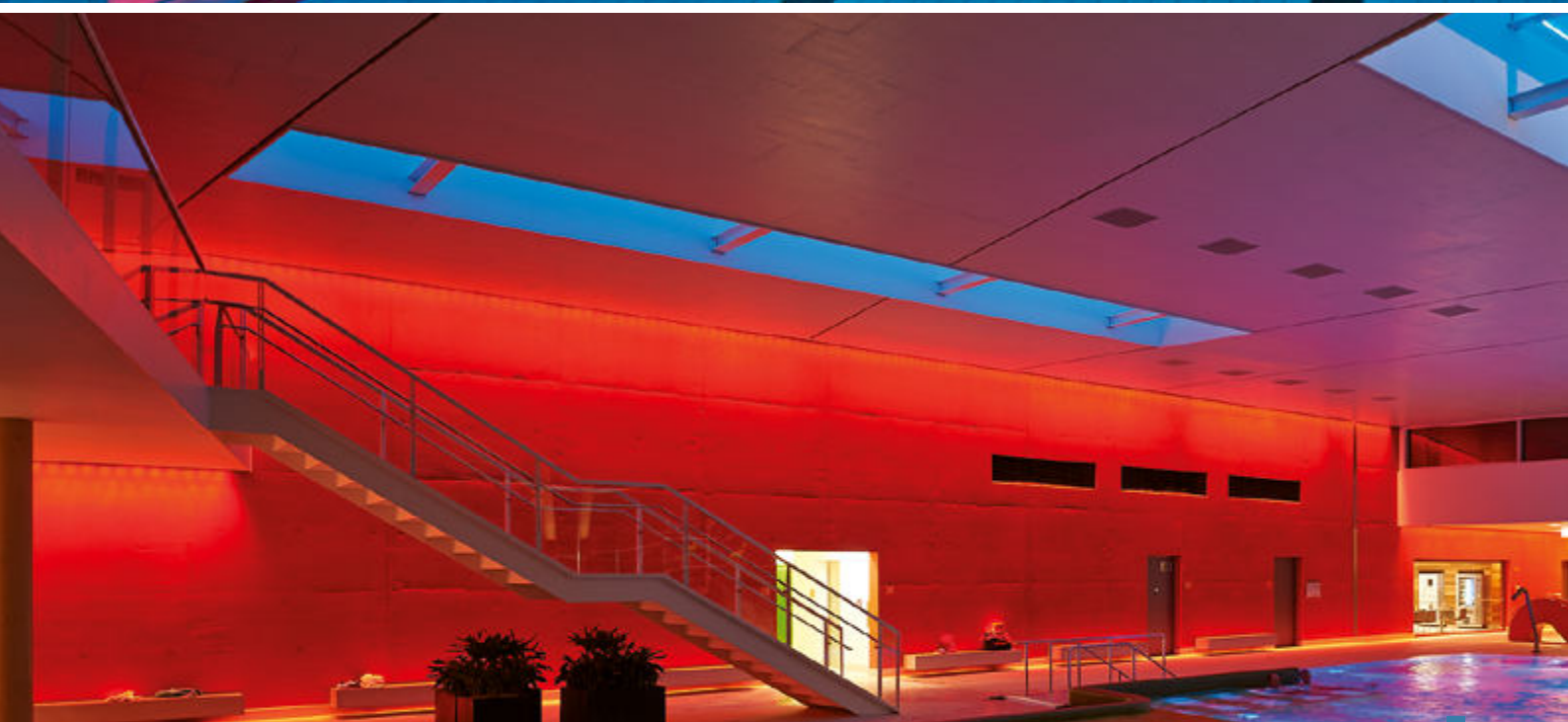

Auebad Kassel

Die gekonnte Lichtinszenierung unterstützt den harmonischen Wechsel zwischen den Wohlfühl- und Erlebnisbereichen. Eine, vom Kunden individuell gewählte Lichtfarbenbestückung, taucht die Wände in ein warmes, farbiges Licht und verstärkt die emotionale Atmosphäre des Raumes. Einen weiteren farbigen Akzent setzen die RGB-Leuchten in den Lichtkuppeln.

Auebad kassel

The skilful lighting design supports the harmonious change between the feel-good and experience areas. Customised light colours immerse the walls in a warm, coloured light and enhance the emotional atmosphere of the room. The RGB luminaires in the skylight domes provide a further colourful accent.



NP Focus-3 4CH

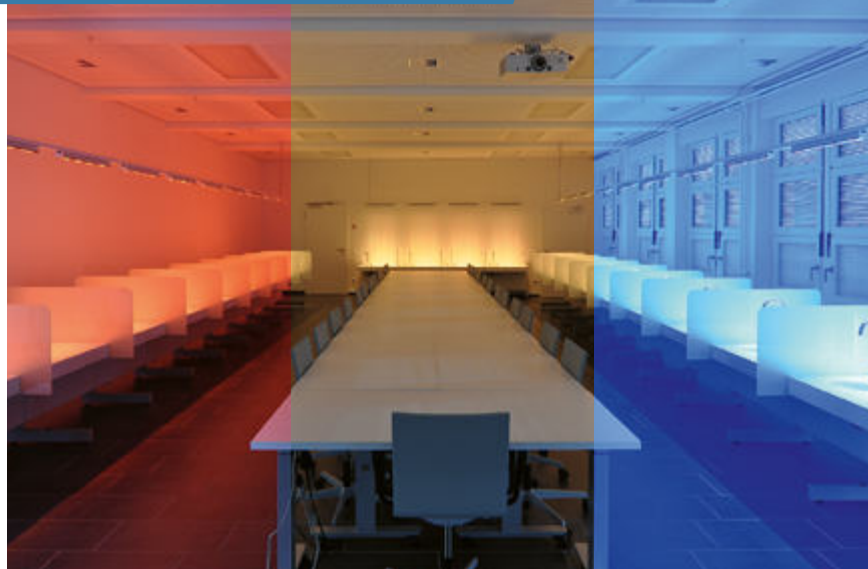

3028 lm/m* | CRI > 90 | 2700 K+ RGB

Gerichtete Lichteffekte in RGBW Regular lighting effect in RGBW

Lichtstarke LEDs in wahlweise R, G, B und unterschiedlichen Weißtönen ermöglichen mit dem Leuchteneinsatz **NauticProfil® Focus-3 4CH** effektvolle Inszenierungen für Schaufenster, Bühnen und Fassaden. Auch das NP Focus-3 4CH arbeitet mit Konstantstromtechnologie und zeichnet sich durch niedrige Eigenerwärmung, hohe Effizienz und lange Lebensdauer aus. Verschiedene Konfigurationen mit unterschiedlichen LEDs und Linsen ermöglichen eine Vielzahl an Einsatzmöglichkeiten.

With the **NauticProfil® Focus-3 4CH** luminaire insert, high-intensity LEDs in the colours R, G, B and various shades of white enable effective staging of shop windows, stages and facades. The NP Focus-3 4CH also works with constant current technology and is characterised by high efficiencies, long life spans and by the fact that it generates little heat. Various configurations with different LEDs and lenses allow for various applications.

effektvolles Lichtspiel
an Fassaden, auf Bühnen
und Ausstellungsflächen

effective play of light
on facades, on stages and
exhibition areas



Binder-Stecker, 6-polig mit 25 cm Kabel
binder-male-connector, 6-contacts with 25 cm cable

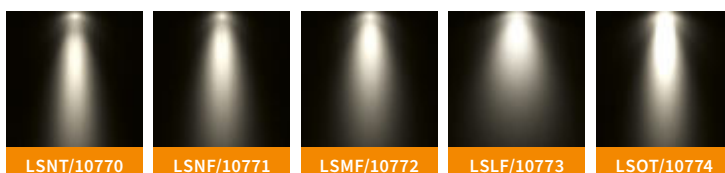

typ. 350mA
535
-20/+35
IP40

characteristics

SPWM
dimming

dimming

IP65
IK10
RAL optional

optional

mounting



* Alle Angaben zum Lumenstrom beziehen sich auf das Leuchtmittel. In Kombination mit Cover/Linsen kommt es zu materialbedingtem Lichtverlust.
All information about the luminous flux refers to the light source. In combination with covers/lenses it comes to material-related light loss.

Bestellnummer item number

NP/F4C/G1/27C

/ F4C/G1/ 0103

/ G1/ ALA

/ XXR

/ XXG

/ XXB

/ 927

/ LSNT/10770

CRT

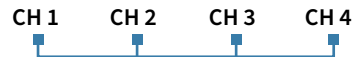

Sonderbestückung der Kanäle in verschiedenen Lichtfarben auf Anfrage möglich.
Special equipment of the channels in different light colours possible on request.

Technische Daten technical data

nominal current: typ. 350 mA (max. 700 mA)
nominal wattage, white: depending on light colour per channel,
e.g. RGBW 26,88 W/m with DALI DT8 dimmer
photometric code: 927/339 (for white) + RGB
LED service life: L80/B10 > 72000h
L90/B10 > 34000h
dimnable: CC pulse width modulation (CC PWM)
length dividing matrix: 83,33 mm
LED pitch: 20,83 mm (inside group),
83,33 mm (between channels)
48 LEDs/m

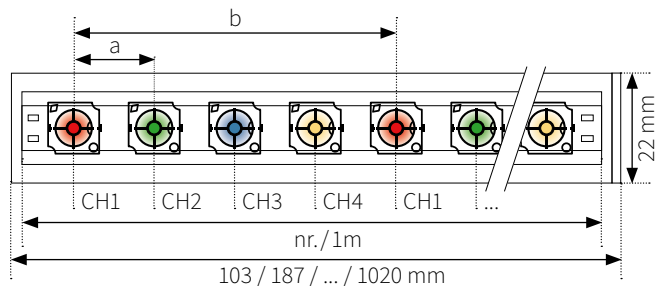
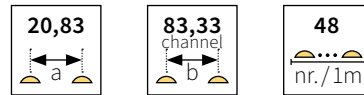

⚠ Alle optischen und elektrischen Daten haben eine Toleranz von +/- 10%.
All optical and electrical data have a tolerance of +/- 10%.

Basisprofil base profile

Das **Basisprofil G1** ist mit allen NP Montageprofilen von FLASHAAR® per Plug&Play kombinierbar. Es ist in den Farben Aluminium (ALA) und Schwarz (BA) eloxiert erhältlich.
The **base profile G1** can be combined with all NP mounting profiles from FLASHAAR® by Plug&Play. It is available in the colours aluminium (ALA) and black (BA) anodised.

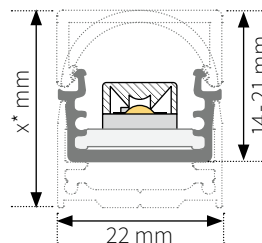

- G1/ALA (Standard)
- G1/BA

* Leuchtenhöhe abhängig vom Montageprofil (21-168 mm), Maße ab S. 8
luminaire height depending on mounting profile (21-168 mm), dimensions from p.8

Übersicht Standardlängen & Wattagen overview standard lengths & wattages

(350 mA)

IP40, IP65						
product-nr.	L (mm)*	C1 Red	C2 Green	C3 Blue	C4 White	total
NP/F4C/G/27C/F4C/G1/0103/G1/ALA/##R/##G/##B/927/...	0103	0,76 W	1,13 W	1,10 W	1,07 W	4,06 W
NP/F4C/G/27C/F4C/G1/0187/G1/ALA/##R/##G/##B/927/...	0187	1,52 W	2,26 W	2,20 W	2,14 W	8,12 W
NP/F4C/G/27C/F4C/G1/0270/G1/ALA/##R/##G/##B/927/...	0270	2,28 W	3,39 W	3,30 W	3,21 W	12,18 W
NP/F4C/G/27C/F4C/G1/0353/G1/ALA/##R/##G/##B/927/...	0353	3,04 W	4,52 W	4,40 W	4,28 W	16,24 W
NP/F4C/G/27C/F4C/G1/0437/G1/ALA/##R/##G/##B/927/...	0437	3,80 W	5,65 W	5,50 W	5,35 W	20,30 W
NP/F4C/G/27C/F4C/G1/0520/G1/ALA/##R/##G/##B/927/...	0520	4,56 W	7,78 W	6,60 W	6,42 W	24,36 W
NP/F4C/G/27C/F4C/G1/0603/G1/ALA/##R/##G/##B/927/...	0603	5,32 W	7,91 W	7,70 W	7,49 W	28,42 W
NP/F4C/G/27C/F4C/G1/0686/G1/ALA/##R/##G/##B/927/...	0686	6,08 W	9,04 W	8,80 W	8,56 W	32,48 W
NP/F4C/G/27C/F4C/G1/0770/G1/ALA/##R/##G/##B/927/...	0770	6,84 W	10,17 W	9,90 W	9,63 W	36,54 W
NP/F4C/G/27C/F4C/G1/0853/G1/ALA/##R/##G/##B/927/...	0853	7,60 W	11,30 W	11,00 W	10,70 W	40,60 W
NP/F4C/G/27C/F4C/G1/0936/G1/ALA/##R/##G/##B/927/...	0936	8,36 W	12,43 W	12,10 W	11,77 W	44,66 W
NP/F4C/G/27C/F4C/G1/1020/G1/ALA/##R/##G/##B/927/...	1020	9,12 W	13,56 W	13,20 W	12,84 W	48,72 W









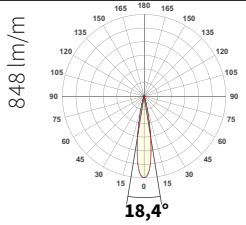
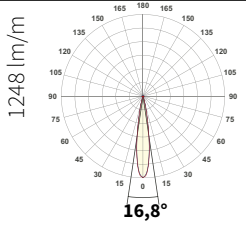
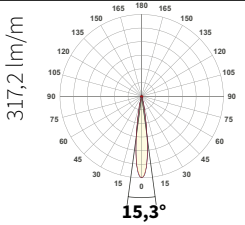
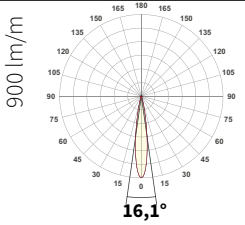

⚠ Aus thermischen Gründen beträgt die zulässige Leistung aller Kanäle 25 W/m, wenn auch die nominelle, elektronische Gesamtleistung 48,72 W/m ist.
Wir empfehlen zum Betrieb des Leuchteneinsatzes einen Lunatone DALI DT8 4-Kanal Dimmer 700 mA.
For thermal reasons, the permissible power of all channels is 25 W/m, although the nominal total electronic power is 48.72 W / m.
We recommend a Lunatone DALI DT8 4-channel dimmer 700 mA for operating the luminaire insert.

Unsere Empfehlung: Dimmer: 89453855-350 DT6 oder 68458912-700 DT8 / Konverter LT60-48
Our Recommendation: Dimmer: 89453855-350 DT6 or 68458912-700 DT8 / Converter LT60-48

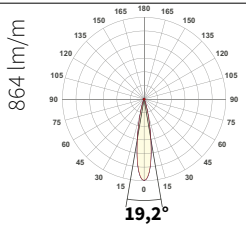
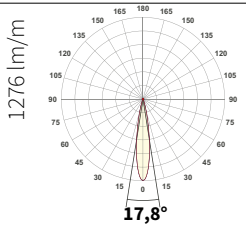
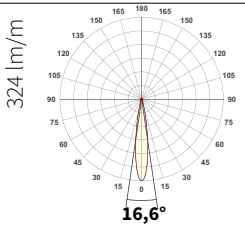
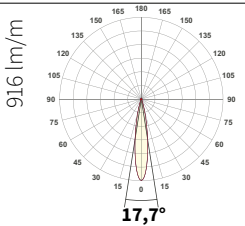
* Länge der Leuchteneinsätze im Innenbereich und Außenbereich (IP65) von 103 mm (nominal 4,06W) bis max. 1020 mm (nominal 48,72W), Teilungsraster ist 83,3 mm.
Light inserts for indoor and outdoor (IP65) use from 103 mm long (nominal 4,06W) up to a maximum length of 1020 mm (nominal 48,72W). The grid uses 83,3 mm increments.

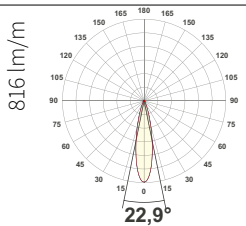
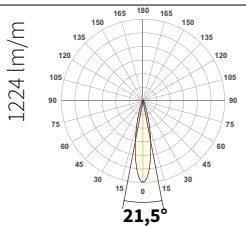
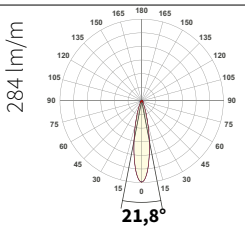
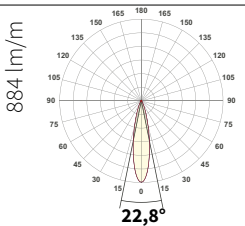
Lichtverteilungskurven NP/F4C/G1/27C

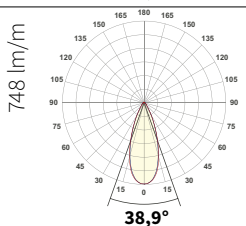
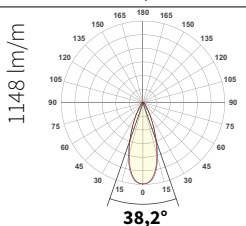
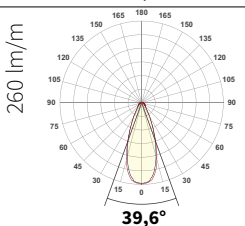
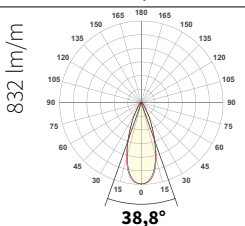
light distribution curves NP/F4C/G1/27C

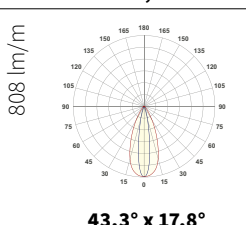
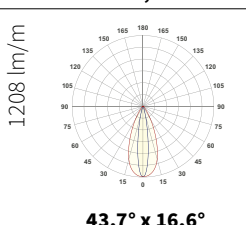
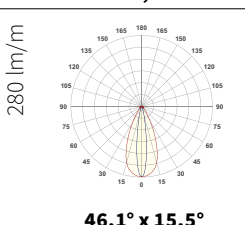
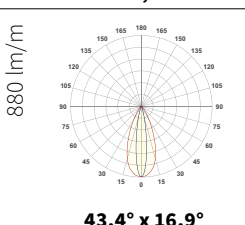
Präzisionslinse precision lens	Lichtverteilungskurve light distribution curve Kanal 1 Rot channel 1 red	Lichtverteilungskurve light distribution curve Kanal 2 Grün channel 2 green	Lichtverteilungskurve light distribution curve Kanal 3 Blau channel 3 blue	Lichtverteilungskurve light distribution curve Kanal 4 Weiß channel 4 white
  precision lens symmetric narrow transparent 16°	848 lm/m  18,4°	1248 lm/m  16,8°	317,2 lm/m  15,3°	900 lm/m  16,1°
  precision lens symmetric narrow frosted 18°	864 lm/m  19,2°	1276 lm/m  17,8°	324 lm/m  16,6°	916 lm/m  17,7°
  precision lens symmetric medium frosted 22°	816 lm/m  22,9°	1224 lm/m  21,5°	284 lm/m  21,8°	884 lm/m  22,8°
  precision lens symmetric large frosted 40°	748 lm/m  38,9°	1148 lm/m  38,2°	260 lm/m  39,6°	832 lm/m  38,8°
  precision lens symmetric oval transparent 42° x 18°	808 lm/m  43,3° x 17,8°	1208 lm/m  43,7° x 16,6°	280 lm/m  46,1° x 15,5°	880 lm/m  43,4° x 16,9°

— 0/180°
— 90/270°

EPREL-Daten:



2700 K



2200 - 6500 K



2700 - 4000 K

Alle lichttechnischen Daten – vermessen im FLASHAAR® Lichtlabor – finden Sie unter flashaar.de im Download-Bereich.

Alle optischen und elektrischen Daten haben eine Toleranz von +/- 10%.

All photometric data – measured in FLASHAAR's light laboratory – available at flashaar.de/en in the download area.

All optical and electrical data have a tolerance of +/- 10%.

Linsen lenses



precision lens
symmetric
narrow transparent
16°



precision lens
symmetric
narrow frosted
18°



precision lens
symmetric
medium frosted
22°



precision lens
symmetric
large frosted
40°

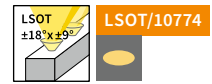

precision lens
symmetric
oval transparent
42° x 18°

Cover/Farbe cover/colour

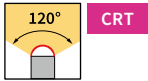

cover round
transparent

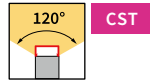

cover square
transparent

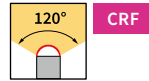

cover round
frosted

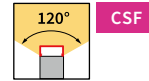

cover square
frosted

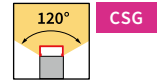

cover square
grey

Verdrahtungsschemata wiring diagrams

D/CC/4/350/DALI-DT6

Version mit max. 350 mA Konstantstrom pro Kanal, DALI DT6 Dimmung
version with max. 350 mA constant current per channel DT6 dimming

Die dargestellte Buchse Binder 718, 6-polig mit Kabel ist Bestandteil der Leuchtenlieferung.
The shown female connector Binder 718, 6-pole with cable is part of the luminaire delivery.

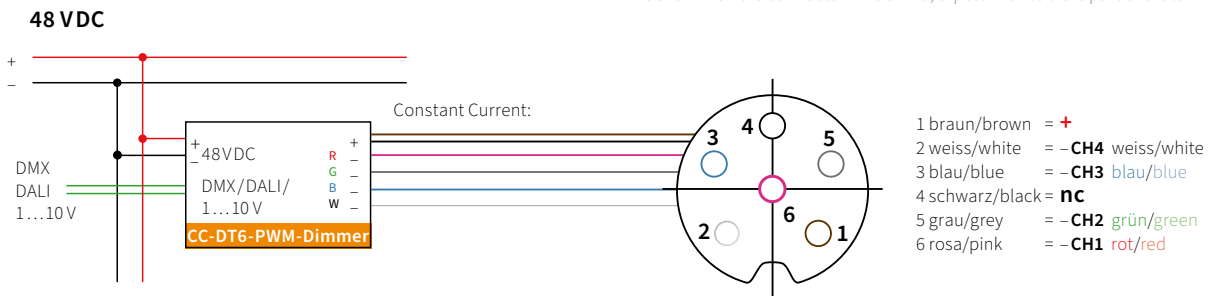

! Beachten Sie die Unterlagen der anzuschließenden Leuchte zum zulässigen Konstantstrom und der zulässigen Gesamtleistung. Die aus thermischen Gründen zulässige Leistung der Summe aller Kanäle ist meist geringer, als die nominelle, elektronische Gesamtleistung aller Kanäle bei 100%. Wir empfehlen daher DALI DT6 Dimmer mit Loadbalancing.

Observe the documents of the luminaire to be connected regarding the permissible constant current and the permissible total power. For thermal reasons, the permissible power of the sum of all channels is usually lower than the nominal, electronic total power of all channels at 100%. We therefore recommend DALI DT6 dimmers with load balancing.

D/CC/4/700/DALI-DT8

Version mit max. 700 mA Konstantstrom pro Kanal, DALI DT8 Dimmung
version with max. 700 mA constant current per channel DT8 dimming

Die dargestellte Buchse Binder 718, 6-polig mit Kabel ist Bestandteil der Leuchtenlieferung.
The shown female connector Binder 718, 6-pole with cable is part of the luminaire delivery.

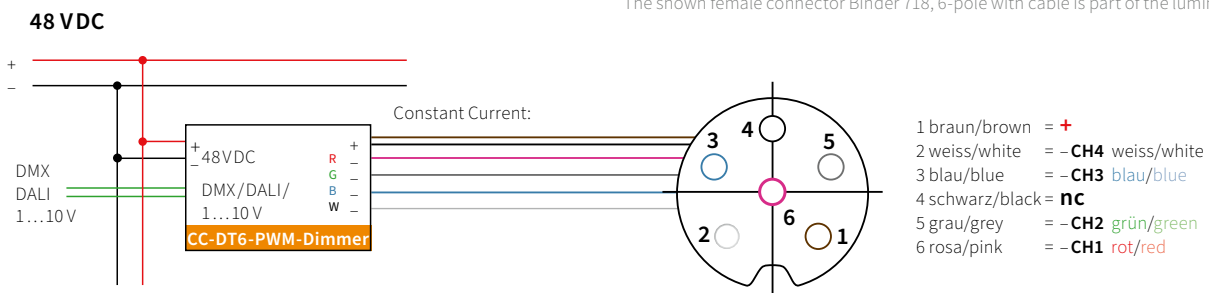

! Beachten Sie die Unterlagen der anzuschließenden Leuchte zum zulässigen Konstantstrom und der zulässigen Gesamtleistung.
Observe the documents of the luminaire to be connected regarding the permissible constant current and the permissible total power.

NP Focus-3 4CH Darklight



3028 lm/m* | CRI > 90 | 2700 K+ RGB

RGBW Lichteffekte ohne Blendung
RGBW light effects without glare

Lichteffekte sind mit dem Leuchteneinsatz **NauticProfil® Focus-3 4CH Darklight** nur auf der Beleuchtungsfläche wahrnehmbar – die LEDs selbst bleiben nahezu blendfrei hinter dem Cover aus hochwertigem Aluminium verborgen. Die HighPowerLEDs sorgen für ausreichend Helligkeit und satte Farben.

Auch für Installationsorte mit langen Zuleitungen ist der Leuchteneinsatz, der mit einem Konstantstrom von typ. 350 mA betrieben wird, perfekt geeignet.

With the **NauticProfil® Focus-3 4CH Darklight** luminaire insert, lighting effects are only perceptible on the lighting surface - the LEDs themselves remain concealed almost glare-free behind the cover made of high-quality aluminium.

The high-power LEDs deliver sufficient brightness and rich colours. The light insert, which is operated with a constant current of typ. 350 mA, is also perfectly suited for installation locations that are associated with long feed lines.

satte Farben, dank
HighPowerLEDs

rich colours, thanks to
HighPowerLEDs

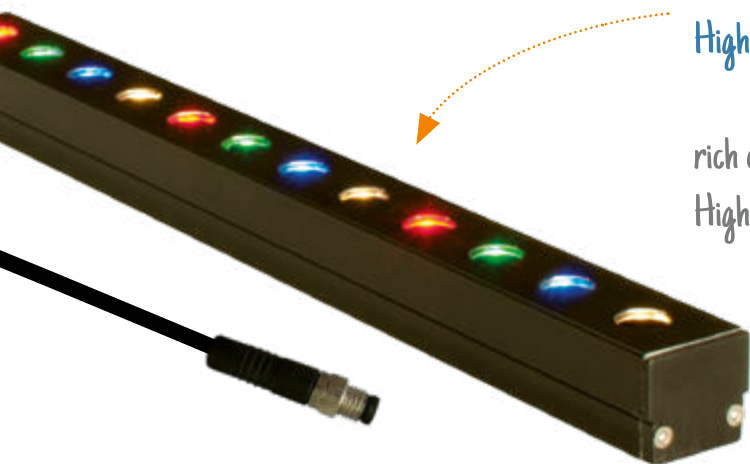

 UGR<19

Binder-Stecker, 6-polig mit 25 cm Kabel
binder-male-connector, 6-contacts with 25 cm cable

ALA (Standard)

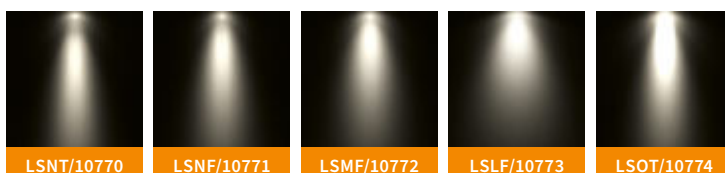

typ. 350mA
475
-20/+35
IP40
characteristics

SPWM
dimming

IK10
RAL optional
optional

mounting

CE  

* Alle Angaben zum Lumenstrom beziehen sich auf das Leuchtmittel. In Kombination mit Cover/Linsen kommt es zu materialbedingtem Lichtverlust.
All information about the luminous flux refers to the light source. In combination with covers/lenses it comes to material-related light loss.

Bestellnummer
item number

NP/DL/F4C/G1/27C / DL/F4C/G1/ 0103 / G1/ ALA / **XXR** / **XXG** / **XXB** / **927** / LSNT/10770 BA

CH 1 CH 2 CH 3 CH 4

Sonderbestückung der Kanäle in verschiedenen Lichtfarben auf Anfrage möglich.
Special equipment of the channels in different light colours possible on request.

Technische Daten
technical data

nominal voltage: typ. 350 mA (max. 700 mA)
 nominal wattage, white: depending on light colour per channel,
 e.g. RGBW 26,88 W/m with DALI DT8 dimmer
 photometric code: 927/339 (for white) + RGB
 LED service life: L80/B10 > 92000h
 L90/B10 > 46000h
 dimmable: CC pulse width modulation (CC PWM)
 length dividing matrix: 83,33 mm
 LED pitch: 20,83 mm (inside group),
 83,33 mm (between channels)
 48 LEDs/m

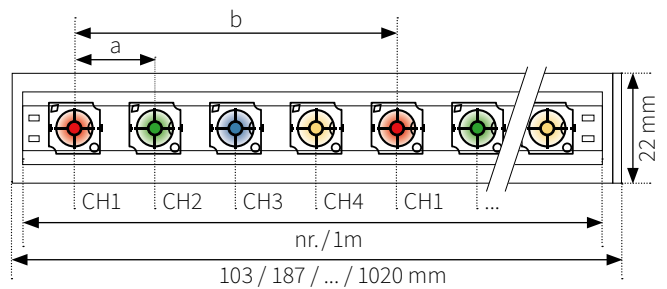
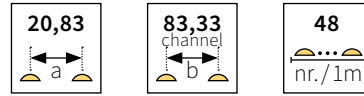

⚠ Alle optischen und elektrischen Daten haben eine Toleranz von +/- 10%.
All optical and electrical data have a tolerance of +/- 10%.

Übersicht Standardlängen & Wattagen
overview standard lengths & wattages

(350 mA)

IP40						
product-nr.	L (mm)*	C1 Red	C2 Green	C3 Blue	C4 White	total
NP/DL/F4C/G1/27C/DL/F4C/G1/0103/G1/ALA/##R/...	0103	0,76 W	1,13 W	1,10 W	1,07 W	4,06 W
NP/DL/F4C/G1/27C/DL/F4C/G1/0187/G1/ALA/##R/...	0187	1,52 W	2,26 W	2,20 W	2,14 W	8,12 W
NP/DL/F4C/G1/27C/DL/F4C/G1/0270/G1/ALA/##R/...	0270	2,28 W	3,39 W	3,30 W	3,21 W	12,18 W
NP/DL/F4C/G1/27C/DL/F4C/G1/0353/G1/ALA/##R/...	0353	3,04 W	4,52 W	4,40 W	4,28 W	16,24 W
NP/DL/F4C/G1/27C/DL/F4C/G1/0437/G1/ALA/##R/...	0437	3,80 W	5,65 W	5,50 W	5,35 W	20,30 W
NP/DL/F4C/G1/27C/DL/F4C/G1/0520/G1/ALA/##R/...	0520	4,56 W	7,78 W	6,60 W	6,42 W	24,36 W
NP/DL/F4C/G1/27C/DL/F4C/G1/0603/G1/ALA/##R/...	0603	5,32 W	7,91 W	7,70 W	7,49 W	28,42 W
NP/DL/F4C/G1/27C/DL/F4C/G1/0686/G1/ALA/##R/...	0686	6,08 W	9,04 W	8,80 W	8,56 W	32,48 W
NP/DL/F4C/G1/27C/DL/F4C/G1/0770/G1/ALA/##R/...	0770	6,84 W	10,17 W	9,90 W	9,63 W	36,54 W
NP/DL/F4C/G1/27C/DL/F4C/G1/0853/G1/ALA/##R/...	0853	7,60 W	11,30 W	11,00 W	10,70 W	40,60 W
NP/DL/F4C/G1/27C/DL/F4C/G1/0936/G1/ALA/##R/...	0936	8,36 W	12,43 W	12,10 W	11,77 W	44,66 W
NP/DL/F4C/G1/27C/DL/F4C/G1/1020/G1/ALA/##R/...	1020	9,12 W	13,56 W	13,20 W	12,84 W	48,72 W









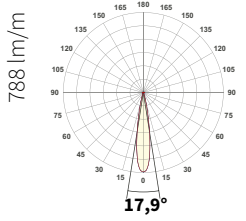
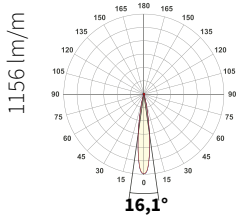
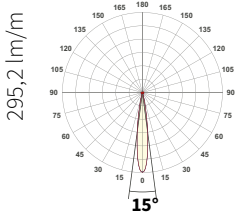
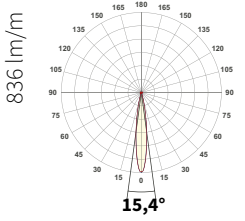

⚠ Aus thermischen Gründen beträgt die zulässige Leistung aller Kanäle 25 W/m, wenn auch die nominelle, elektronische Gesamtleistung 48,72 W/m ist.
Wir empfehlen zum Betrieb des Leuchteneinsatzes einen Lunatone DALI DT8 4-Kanal Dimmer 700 mA.
For thermal reasons, the permissible power of all channels is 25 W/m, although the nominal total electronic power is 48.72 W / m.
We recommend a Lunatone DALI DT8 4-channel dimmer 700 mA for operating the luminaire insert.

Unsere Empfehlung: Dimmer: 89453855-350 DT6 oder 68458912-700 DT8 / Konverter LT60-48
Our Recommendation: Dimmer: 89453855-350 DT6 or 68458912-700 DT8 / Converter LT60-48

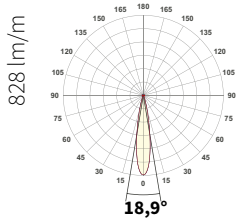
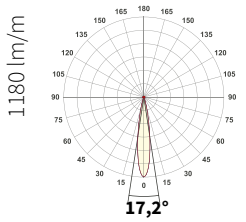
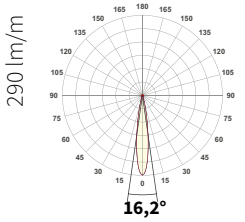
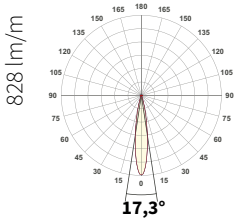
* Länge der Leuchteneinsätze im Innenbereich von 103 mm (nominal 4,06W) bis max. 1020 mm (nominal 48,72W), Teilungsraster ist 83,3 mm.
Light inserts for indoor use from 103 mm long (nominal 4,06W) up to a maximum length of 1020 mm (nominal 48,72W). The grid uses 83,3mm increments.

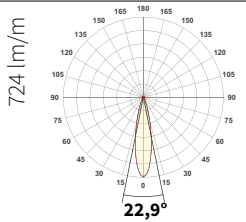
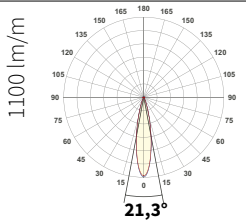
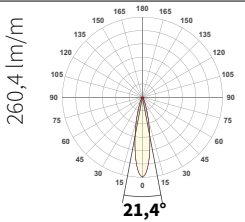
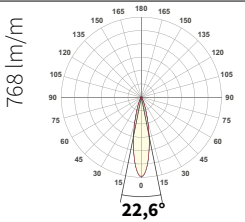
Lichtverteilungskurven NP/DL/F4C/G1/27C

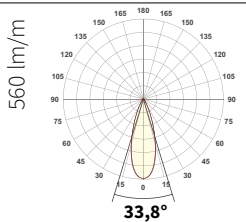
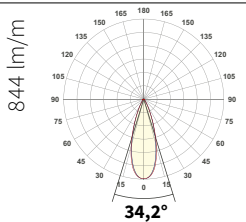
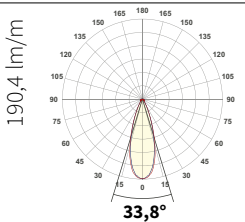
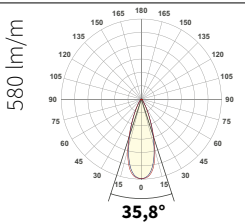
light distribution curves NP/DL/F4C/G1/27C

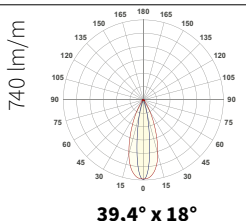
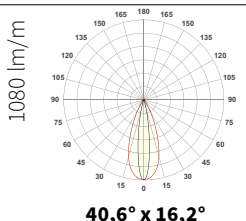
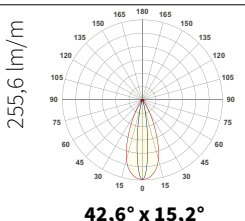
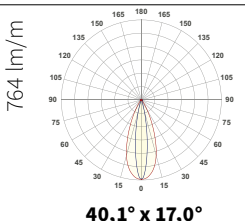
Präzisionslinse precision lens	Lichtverteilungskurve light distribution curve Kanal 1 Rot channel 1 red	Lichtverteilungskurve light distribution curve Kanal 2 Grün channel 2 green	Lichtverteilungskurve light distribution curve Kanal 3 Blau channel 3 blue	Lichtverteilungskurve light distribution curve Kanal 4 Weiß channel 4 white
  precision lens symmetric narrow transparent 16°	788 lm/m  17,9°	1156 lm/m  16,1°	295,2 lm/m  15°	836 lm/m  15,4°
  precision lens symmetric narrow frosted 18°	828 lm/m  18,9°	1180 lm/m  17,2°	290 lm/m  16,2°	828 lm/m  17,3°
  precision lens symmetric medium frosted 22°	724 lm/m  22,9°	1100 lm/m  21,3°	260,4 lm/m  21,4°	768 lm/m  22,6°
  precision lens symmetric large frosted 40°	560 lm/m  33,8°	844 lm/m  34,2°	190,4 lm/m  33,8°	580 lm/m  35,8°
  precision lens symmetric oval transparent 42° x 18°	740 lm/m  39,4° x 18°	1080 lm/m  40,6° x 16,2°	255,6 lm/m  42,6° x 15,2°	764 lm/m  40,1° x 17,0°

 0/180°
 90/270°

UGR < 19



Alle lichttechnischen Daten – vermessen im FLASHAAR® Lichtlabor – finden Sie unter flashaar.de im Download-Bereich.
 Alle optischen und elektrischen Daten haben eine Toleranz von +/- 10%.
 All photometric data – measured in FLASHAAR's light laboratory – available at flashaar.de/en in the download area.
 All optical and electrical data have a tolerance of +/- 10%.

Linsen lenses



precision lens
symmetric
narrow transparent
16°



precision lens
symmetric
narrow frosted
18°



precision lens
symmetric
medium frosted
22°



precision lens
symmetric
large frosted
40°

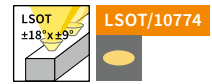

precision lens
symmetric
oval transparent
42° x 18°

Gehäusefarben* housing colours*

Die Focus-4 1CH Darklight ist wahlweise in folgenden Gehäusefarben erhältlich:
The Focus-4 1CH Darklight is available in the following housing colours:



alu anodized (standard)
E6EV1



black anodized
E6C14



RAL 9016 traffic white
fine structure
(powdered)

* Beachten Sie bitte bei der Planung / Bestellung der ergänzenden Montageprofile eine passende Farbe.
When planning/ordering the supplementary mounting profiles, please make sure you choose a suitable colour.

Verdrahtungsschemata wiring diagrams

D/CC/4/350/DALI-DT6

Version mit max. 350 mA Konstantstrom pro Kanal, DALI DT6 Dimmung
version with max. 350 mA constant current per channel DT6 dimming

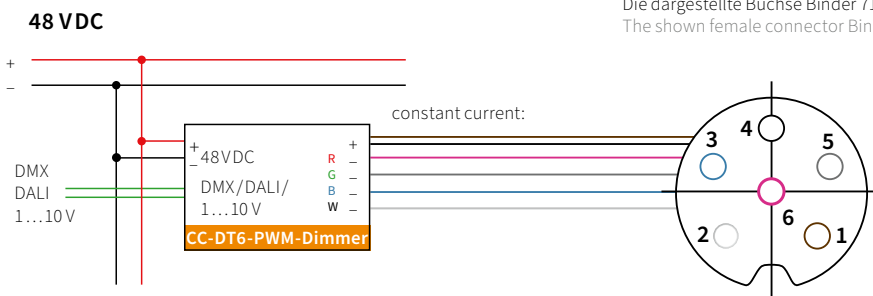

- 1 braun/brown = +
- 2 weiss/white = -CH4 weiss/white
- 3 blau/blue = -CH3 blau/blue
- 4 schwarz/black = nc
- 5 grau/grey = -CH2 grün/green
- 6 rosa/pink = -CH1 rot/red

⚠ Beachten Sie die Unterlagen der anzuschließenden Leuchte zum zulässigen Konstantstrom und der zulässigen Gesamtleistung. Die aus thermischen Gründen zulässige Leistung der Summe aller Kanäle ist meist geringer, als die nominelle, elektronische Gesamtleistung aller Kanäle bei 100%. Wir empfehlen daher DALI DT6 Dimmer mit Loadbalancing.

Observe the documents of the luminaire to be connected regarding the permissible constant current and the permissible total power. For thermal reasons, the permissible power of the sum of all channels is usually lower than the nominal, electronic total power of all channels at 100%. We therefore recommend DALI DT6 dimmers with load balancing.

D/CC/4/700/DALI-DT8

Version mit max. 700 mA Konstantstrom pro Kanal, DALI DT8 Dimmung
version with max. 700 mA constant current per channel DT8 dimming

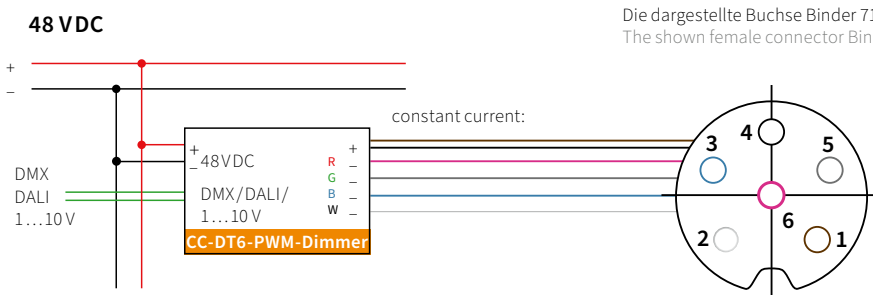

- 1 braun/brown = +
- 2 weiss/white = -CH4 weiss/white
- 3 blau/blue = -CH3 blau/blue
- 4 schwarz/black = nc
- 5 grau/grey = -CH2 grün/green
- 6 rosa/pink = -CH1 rot/red

⚠ Beachten Sie die Unterlagen der anzuschließenden Leuchte zum zulässigen Konstantstrom und der zulässigen Gesamtleistung.
Observe the documents of the luminaire to be connected regarding the permissible constant current and the permissible total power.



© Kath. Kirche St. Petrus, Tübingen-Lustnau / Ernesto Martens

Konfigurationen 4CH Darklight configurations 4CH Darklight

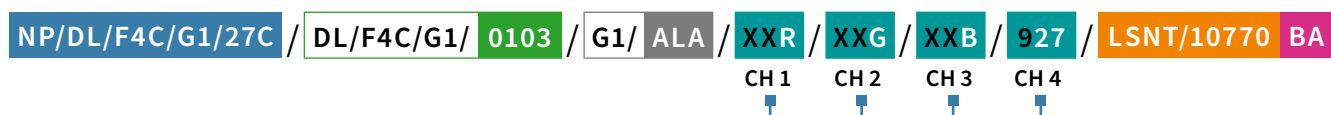

Typ type	CH 1 I=350 mA	CH 2 I=350 mA	CH 3 I=350 mA	CH 4 I=350 mA
4CH, RGB + 840	red 620-630 nm 672lm/m	green 520-525 nm 1212lm/m	royal blue 620-630 nm 250lm/m	4000 K, CRI > 80 1408lm/m
	X X R	X X G	X X B	8 4 0
4CH, RGB + 927	red 620-630 nm 672lm/m	green 520-525 nm 1212lm/m	royal blue 620-630 nm 250lm/m	2700 K, CRI > 90 912lm/m
	X X R	X X G	X X B	9 2 7
4CH, 822 + 930	2200 K, CRI > 80 832lm/m	3000 K, CRI > 90 996lm/m	2200 K, CRI > 80 832lm/m	3000 K, CRI > 90 996lm/m
	8 2 2	9 3 0	8 2 2	9 3 0
4CH, 972 + 840	2700 K, CRI > 90 912lm/m	4000 K, CRI > 80 1408lm/m	2700 K, CRI > 90 912lm/m	4000 K, CRI > 80 1408lm/m
	9 2 7	8 4 0	9 2 7	8 4 0

Konfigurationen für eine Leuchte mit 270 mm Länge, RGB + 4000 K, symmetrischer Linse schmal 8° transparent.
Configurations for a luminaire with 270 mm length, RGB + 4000 K, symmetrical lens narrow 8° transparent.

Bei Bestellungen die Artikelnummer um die gewünschte Lichtfarben, Linse und Gehäusefarbe ergänzen.

When ordering please complete the item number with the desired light colour, lens type and housing colour.

Beispiel Art.Nr für NP Focus-3 4CH RGBW
example item nr. for NP Focus-3 4CH RGBW

.../XXR XXG XXB 927/###



Beispiel Art.Nr. für NP Focus-3 4CH mit Kelvinshifting 2200 + 3000 K
example item nr. NP Focus-3 4CH with kelvinshifting 2200 + 3000 K

.../822 930 822 930/###

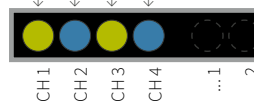



Sonderausführung NP Focus-3 4CH Darklight e-Zoom special version NP Focus-3 4CH Darklight e-Zoom



Der NP Focus-3 4CH DL **e-Zoom** ist eine Sonderausführung, bei der die vier Kanäle abwechselnd mit einer 16° Spotlinse LSNT/10770 und einer 40° Breit-Linse LSLF/10773 bestückt sind. Durch gezielte Ansteuerung dieser Kanäle kann die Leuchte elektronisch Zoomen und Sie den Abstrahlwinkel per Steuerung ändern. Da die 4 Kanäle auf die zwei Linsen aufgeteilt sind, macht die farbige Bestückung nur als monochromatische oder 2-kanalige Ausführung Sinn.

The NP Focus-3 4CH DL **e-Zoom** is a special edition in which the four channels are alternately equipped with a 16° spot lens LSNT/10770 and a 40° wide lens LSLF/10773. Through targeted control of these channels, the luminaire can zoom electronically and you can change the beam angle through the control. Since the 4 channels are divided between the two lenses, the color arrangement only makes sense as a monochromatic or 2-channel version.

Konfigurationen e-Zoom* configurations e-Zoom*

Typ type	CH 1&4	CH 2&3
4CH, 822 + 930	2200 K, CRI > 80, 832lm/m	3000 K, CRI > 90, 996lm/m
	8 2 2	9 3 0
4CH, 927 + 840	2700 K, CRI > 90, 912lm/m	4000 K, CRI > 80, 1408lm/m
	9 2 7	8 4 0
4CH, 927	2700 K, CRI > 90, 912lm/m	2700 K, CRI > 90, 912lm/m
	9 2 7	9 2 7
4CH, 840	4000 K, CRI > 80, 1408lm/m	2700 K, CRI > 90, 912lm/m
	8 4 0	8 4 0

Beispiel Art.Nr. für NP Focus-3 4CH Darklight e-Zoom mit Kelvinshifting 2200 + 3000 K
example Item Nr. NP Focus-3 4CH Darklight e-Zoom with kelvinshifting 2200 + 3000 K

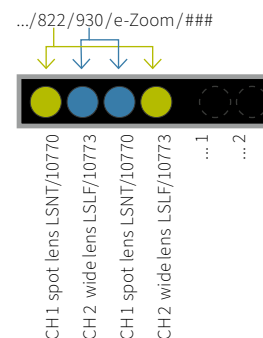

Bei Bestellungen die Artikelnummer um die gewünschte Lichtfarbe und Gehäusefarbe ergänzen, sowie um den Bestellvermerk „**e-Zoom**“.

When ordering please complete the item number with the desired light colour and housing colour type, as well as the order note “**e-Zoom**”.

* Beispiele, beliebige Zweier-Kombinationen der Farben XXR, XXG, XXB, 822, 927, 939, 840 möglich, Werte siehe Konfigurationen 4Channel.
Examples, any combinations of two colors XXR, XXG, XXB, 822, 927, 939, 840 possible, for values see configurations 4Channel.

Profil® - ein Klick, viele Lösungen

wicklung r on

PlayMontageprinzip

nie
elektrischen Einspeisung

Technik
anwendungen



NauticProfil® PicoSpot Familie

NauticProfil® PicoSpot Family



Akzentlicht für die Rochuskapelle Bingen am Rhein

Das neue Beleuchtungskonzept der Rochuskapelle erstreckt sich wie ein „goldenes Triptychon“ über den frisch restaurierten Marienaltar, Rochus- und Hildegardisaltar. Insgesamt lenken 48 PicoSpot Leuchten von FLASHAAR® ihr warmweißes Licht gezielt auf die Kunstschätze der Altäre und betonen ihre Details.

Accent lighting for the „Rochuskapelle Bingen am Rhein“

The new lighting concept of the Rochus Chapel stretches like a „golden triptych“ over the freshly restored Marian altar, Rochus- and Hildegardis altar. 48 PicoSpot luminaires from FLASHAAR direct their warm white light specifically onto the art treasures of the altars and emphasise their details.

NauticProfil® PicoSpots

NauticProfil® PicoSpots

Viele Kunden wünschten sich von FLASHAAR® auch lichttechnisch orientierte Strahler in unser bewährtes NauticProfil® System einzubauen. Dem Wunsch entsprechend, entwickelten wir die dezente, aber mächtige Produktfamilie NauticProfil® PicoSpot. Das minimalistische Design überrascht mit einer Vielzahl an Möglichkeiten der gerichteten Lichtenwendungen zwecks unterschiedlichster Akzentuierungen.

Sie haben die Wahl eines Leuchteinsatzes von einem bis zu zwölf Leuchtköpfen, mit jeweils rund 2 Watt und 120 Lumen (entspricht in etwa einer 15 W Halogen Reflektorlampe). Von dem einzelnen Spot zur Hervorhebung eines Dekorationsgegenstandes bis zum zwölf-flammigen Einsatz als Ausleuchtungswerkzeug einer Bilderwand beleuchteten NP PicoSpot individuell Räume, Wände oder Einrichtungsobjekte und setzen Akzente wo es erwünscht ist.

Die speziellen Markenlinsen lassen sich nach Bedarf bei jeder Flamme einfach und individuell austauschen um die Lichteigenschaft zwischen hartem Spot bis zu weichem, breitem Lichtkegel anzupassen. Dank des magnetischen Drehgelenks drehen und schwenken Sie jeden Leuchtenkopf unabhängig voneinander um ca. 135° in der Senkrechten und 360° in der Waagrechten, bezogen auf die Montagefläche.

Durch verschiedene Farbtemperaturen (2700-4000 K) in Kombination mit der exzellenten Farbwiedergabe von einem CRI > 90, bietet unsere NP PicoSpot Familie die ideale Lösung für eine Vielzahl von Anwendungen. Angepasst auf die jeweiligen Verdrahtungsschemata des NauticProfil®, harmonisieren alle NP PicoSpots mit den unterschiedlichen Leuchteinsätzen 24 und 48 V, schaltbar oder dimmbar und sind mit einem einfachen „Klick“ in das jeweilige NP Montageprofil eingesetzt.

Für Sonderwünsche wie (Licht-)Farbe, Steuerungsoptionen, spezielle Abmessungen etc.pp. sprechen Sie uns bitte an.

Many customers also wanted flashaar® to incorporate light-oriented spotlights into our proven NauticProfil® system. In response to this desire, we have developed the unobtrusive but powerful NauticProfil® PicoSpot product family. The minimalist design offers an astonishing number of options for directional lighting applications to create a wide variety of accents.

You can choose a light fixture with between one and twelve lamp heads, each with around 2 Watts and 120 Lumens (roughly equivalent to a 15 W halogen reflector luminaire). From an individual spotlight to emphasise a decorative object to the use of twelve luminaires as a light source for a picture wall, the NP PicoSpot is customisable and illuminates rooms, walls or furnishings and sets accents where spotlights are desired.

The special, branded lenses can be easily and individually changed for each luminaire in order to adjust the light characteristics from a hard spotlight to a soft, wide light cone. Thanks to the magnetic swivel joint, you can tilt and turn each luminaire head independently by approximately 135° vertically and 360° horizontally in relation to the mounting surface.

With different colour temperatures (2700 K-4000 K) and excellent colour rendering of CRI > 90, our NP PicoSpot family offers the ideal solution for a wide range of applications. Adapted to the respective wiring diagrams of the NauticProfil®, all NP PicoSpots units harmonise with the different light fittings – 24 and 48 V DC, switchable or dimmable – and can be inserted into the respective NP mounting profile with a simple „click“.

For special requests such as (light) colour, control options, special dimensions etc.pp. please contact us.

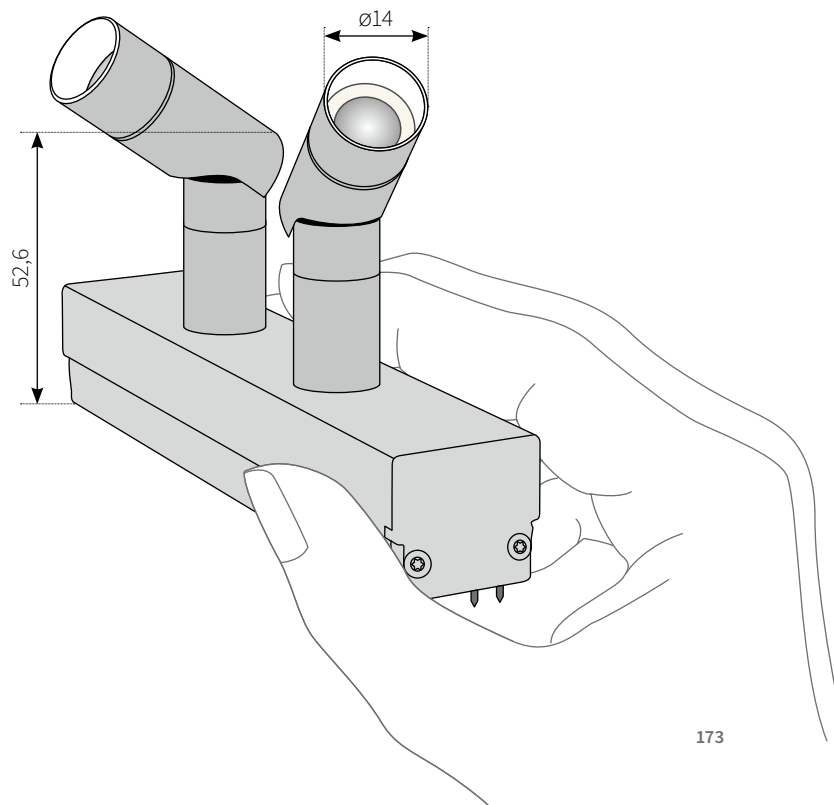

NP PicoSpots

Zielgerichtete Akzentbeleuchtung im schlanken Design

Unsere **NauticProfil® PicoSpot Familie** bietet eine Vielzahl an Möglichkeiten innerhalb des NauticProfil® Systems. Das geradlinige und filigrane Design in Natureloxal oder Schwarz prädestiniert die NP PicoSpots für den Einsatz in Museen, Galerien oder repräsentativen Situationen, in denen Exponate mit hoher Farbwiedergabequalität schonend beleuchtet werden müssen.

Sie sind smart konstruiert und hochwertig verarbeitet, bieten weite Verstellungen, verschiedene Lichtfarben und auswechselbare Optiken. Die komplett integrierte Technik lässt den Einsatz Seite an Seite mit allen linearen FLASHAAR® Leuchteneinsätzen innerhalb eines Profils, dank dem bewährten Plug&Play Montageprinzips, zu.

Targeted accent lighting in a slim design

Our **NauticProfil® PicoSpot family** offers a wide range of possibilities within the NauticProfil® system. The linear and filigree design in a natural colour or in black makes the NP PicoSpots ideal for use in museums, galleries or prestigious situations where exhibits need to be gently illuminated with high colour rendition quality.

They are smartly designed and of high quality workmanship, offering wide adjustments, different light colours and interchangeable optics. The completely integrated technology allows side-by-side use with all linear flashaar® luminaire inserts within a profile, thanks to the proven plug & play mounting principle.

TIPP

Die Länge kann auf Anfrage individuell angepasst werden.
The length is variable and can be customized.

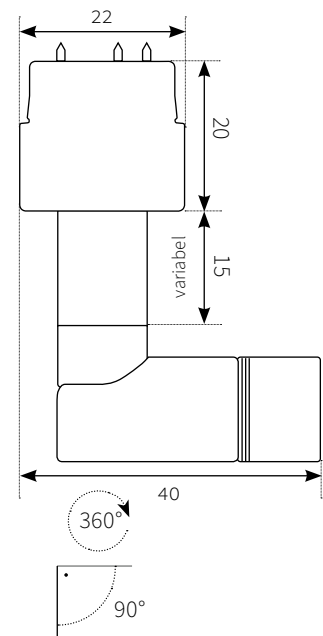
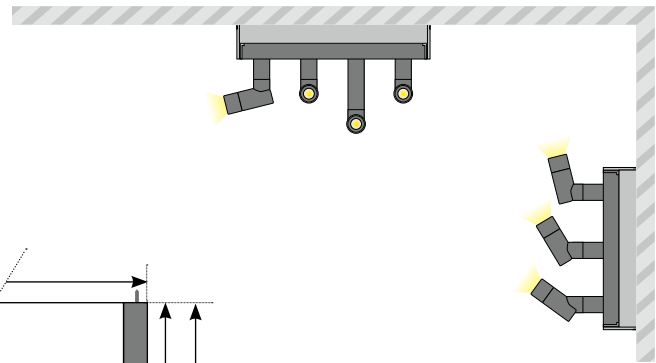
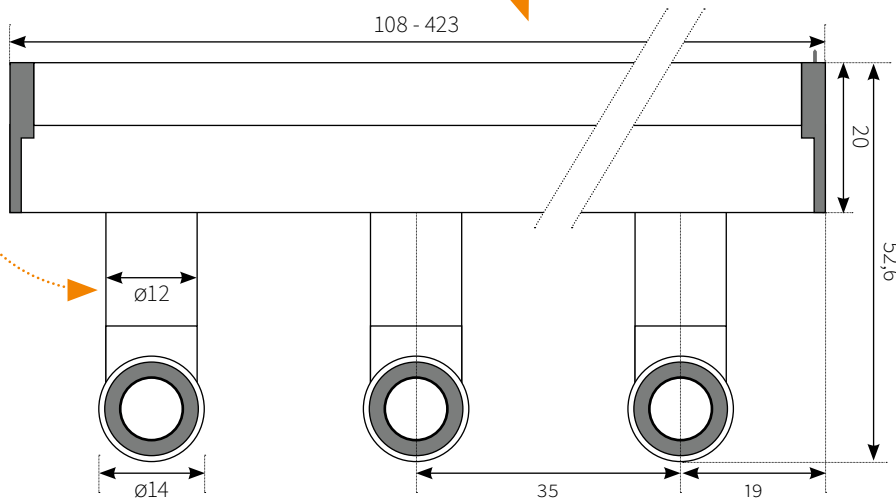

 .../ALA
alu anodized (standard)
E6EV1

 .../BA
black anodized
E6C14

Sonderfarben auf Anfrage! Special colours on request!

Maßstab 1:1 / Alle Maßangaben in mm.
scale 1:1 / All dimensions in mm.

Bitte bei NP Profil- und Endplatten-Bestellung die Art.Nr. um die gewünschte Farbe ergänzen. Bei gewünschtem Gehrungsschnitt die Art.Nr. um die Gradzahl, bei Bestellung des NP Flachkabels die Art.Nr. um die entsprechende Länge (mm) ergänzen. Bitte beachten Sie unser Formular für NauticProfil® Eck-Konfigurationen im Katalog und unter www.flashaar.de

Please state the required colour with the article number when ordering NP profiles and end plates. Please state the required angle with the article number when ordering bevel cuts and state the corresponding length (mm) with the article number when ordering NP flat cables. Please take note of our form for NauticProfil® corner-connections and also at www.flashaar.de



characteristics



dimming



optional

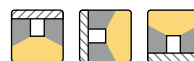



Bestellnummer item number

FLNP/PS1C/CXX / 0108 / 9 27 / LSMT/10995 ALA

XX = Anzahl der Spots
XX = number of spots

Technische Daten technical data

nominal voltage:	12-48 V DC	luminous efficiency [typ]:	ca. 60 lm/W
nominal wattage:	ca. 2W/spot	LED service life:	L80/B10 > 72000 h / L90/B10 > 34000 h
photometric code:	9XX/339; CRI 92 8XX/339; CRI 83	dimmable:	SPWM

Lichtverteilungskurven light distribution curves

IP40

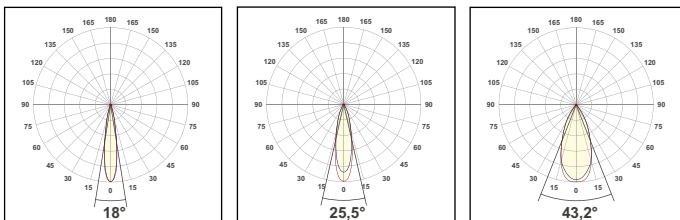

Drei verschiedene rotationssymmetrische Linsen mit 18°, 26° und 43° Ausstrahlungswinkel stehen für die PicoSpot Familie zur Auswahl.

Three different rotation-symmetrical lenses with 18°, 26° and 43° beam angle are available for the PicoSpot Family.

EPREL-Daten:



2700 K, 350mA



2700 K, 500mA



3000 K, 350mA



3000 K, 500mA

Farbtemperatur und Lumenstrom colour temperature and luminous flux

Farbtemperatur colour temperature	WW 2200 K	WW 2700 K	WW 3000 K	NW 4000 K
CRI typ.	83	92	92	83
Lumenstrom luminous flux*	ca. 111 lm/spot	ca. 122 lm/spot	ca. 132 lm/spot	ca. 188 lm/spot
	822	927	930	840

* Alle Angaben zum Lumenstrom beziehen sich auf das Leuchtmittel.
* All information about the luminous flux refers to the light source.

Artikel, Zubehör und Optionen articles, accessories and options



/LSST/16558
(~18°, Ø 10.0 mm, H 7,9 mm)

Linse Lisa 15°
lens Lisa 15°



/LSMT/10995
(~26, Ø 9.9 mm, H 6,8 mm)

Linse Lisa 20°
lens Lisa 20°















/LSWT/10996
(~43, Ø 9.9 mm, H 6,8 mm)

Linse Lisa 35°
lens Lisa 35°

NP PicoSpot Familie - Übersicht

NP PicoSpot family - overview

	FLNP/PS1C/C01/0108/###/###	FLNP/PS1C/C02/0108/###/###	FLNP/PS1C/C03/0108/###/###
			
scale (BxTxH)	108 x 22 x 64 mm		
nom. wattage	ca. 2 W/spot	ca. 4 W/spot	ca. 6 W/spot
luminous flux	ca. 120 lm	ca. 240 lm	ca. 360 lm
colour temp./CRI	2200 K, CRI typ. 83 // 2700 K, CRI typ. 92 // 3000 K, CRI typ. 92 // 4000 K, CRI typ. 83		
	FLNP/PS1C/C04/0143/###/###	FLNP/PS1C/C05/0178/###/###	FLNP/PS1C/C06/0213/###/###
			
scale (BxTxH)	143 x 22 x 64 mm	178 x 22 x 64 mm	213 x 22 x 64 mm
nom. wattage	ca. 8 W/spot	ca. 10 W/spot	ca. 12 W/spot
luminous flux	ca. 480 lm	ca. 600 lm	ca. 720 lm
colour temp./CRI	2200 K, CRI typ. 83 // 2700 K, CRI typ. 92 // 3000 K, CRI typ. 92 // 4000 K, CRI typ. 83		
	FLNP/PS1C/C07/0248/###/###	FLNP/PS1C/C08/0283/###/###	FLNP/PS1C/C09/0318/###/###
			
scale (BxTxH)	248 x 22 x 64 mm	283 x 22 x 64 mm	318 x 22 x 64 mm
nom. wattage	ca. 14 W/spot	ca. 16 W/spot	ca. 18 W/spot
luminous flux	ca. 840 lm	ca. 960 lm	ca. 1080 lm
colour temp./CRI	2200 K, CRI typ. 83 // 2700 K, CRI typ. 92 // 3000 K, CRI typ. 92 // 4000 K, CRI typ. 83		
	FLNP/PS1C/C10/0353/###/###	FLNP/PS1C/C11/0388/###/###	FLNP/PS1C/C12/0423/###/###
			
scale (BxTxH)	353 x 22 x 64 mm	388 x 22 x 64 mm	423 x 22 x 64 mm
nom. wattage	ca. 20 W/spot	ca. 22 W/spot	ca. 24 W/spot
luminous flux	ca. 1200 lm	ca. 1320 lm	ca. 1440 lm
colour temp./CRI	2200 K, CRI typ. 83 // 2700 K, CRI typ. 92 // 3000 K, CRI typ. 92 // 4000 K, CRI typ. 83		

Achtung! Die NP PicoSpots **C07-C12** haben jeweils 2 Ansteuerplatine, Typ SOPN-Pico/FLA.
Attention! The NP PicoSpots **C07-C12** each have 2 control boards, type SOPN-Pico/FLA.

Verdrahtungsschemata wiring diagrams

24V / 48V DC

D/PWM/1b & D/SPWM/1c (1x1CH PWM + 1x1CH SPWM)

Dimmbar, System bestehend aus 1CH NP Leuchteinsatz PWM und 1CH NP Leuchteinsatz SPWM
(Kombination aus Leistungs-PWM und Steuerungs-PWM)
dimmable, system consisting of 1CH NP light insert PWM and 1CH NP light insert SPWM
(combination of performance PWM and control PWM)

+SPWM short to: -SPWM / -24 / -48V / GND=ON;
+SPWM open or short to +24 / +48V=OFF

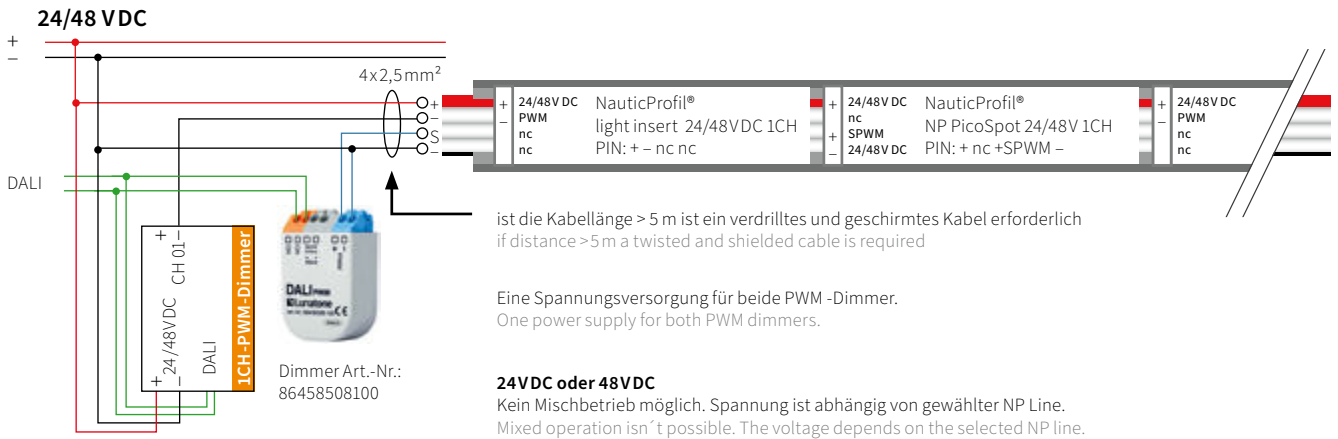
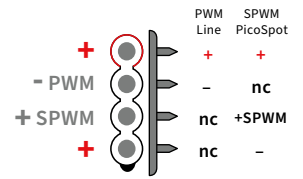

D/SPWM/2 (2x1CH)

zum Dimmen aller 1CH Leuchteinsätze auf 2 Kanälen, die mit einem PWM-Steuerungssignal für PWM-Erzeugung auf Platine gedimmt werden
for dimming all 1CH light inserts on 2 channels, which are dimmed with a PWM control signal for PWM generation on the board

+SPWM short to: -SPWM / -48V / GND=ON;
+SPWM open or short to +48V=OFF

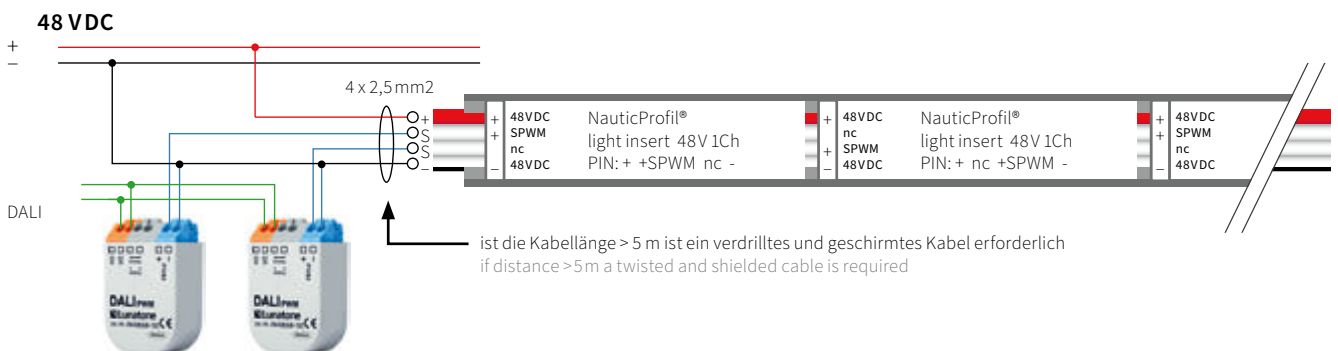
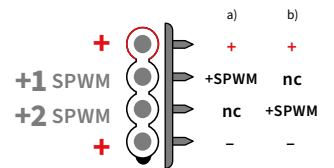

FLASHAAR® Pico Konstantstrom Platine-1

Konstantstromregler mit PWM-Eingang zum geräuschlosen Dimmen von CC-LED

- Kompakte Steuereinheit für CC-LED
- Step-down Wandler
- Schaltfrequenz: 500 kHz
- Stufenlos dimmbar mittels PWM
- hohe Strombelastbarkeit von bis zu 0,7A
- hohe Ausgangsleistung von bis zu 35W
- Löt pads am Ein- und Ausgang
- Elkos garantieren geräuschloses Dimmen
- ideal zur Integration in Stehleuchten, Tischleuchten, Wandleuchten, Pendelleuchten oder zum Einbau in Haushaltsgeräte, wie Dunstabzugshauben usw.
- Hervorragend geeignet zur Ansteuerung mittels Lunatone DALI PWM #86458508-100
- Parallelschaltung von bis zu 60 Stück FL/FPC-1 an einem DALI PWM #86458508-100 möglich.

constant current controller with PWM input for noiseless dimming of CC LED

- compact control unit for CC-LED
- step-down Converter
- switching frequency: 500 kHz
- infinitely dimmable by means of PWM
- high current carrying capacity of up to 0.7 A
- high output power of up to 35 W
- solder pads at input and output
- Elkos guarantee noiseless dimming
- ideal for integration in floor luminaires, table luminaires, wall luminaires, pendant luminaires or for installation in household appliances, such as extractor hoods, etc.
- excellently suited for approach control by means of Lunatone DALI PWM #86458508-100
- parallel connection of up to 60 units FL/FPC-1 on one DALI PWM #86458508-100 possible

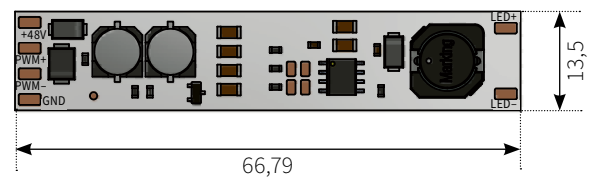
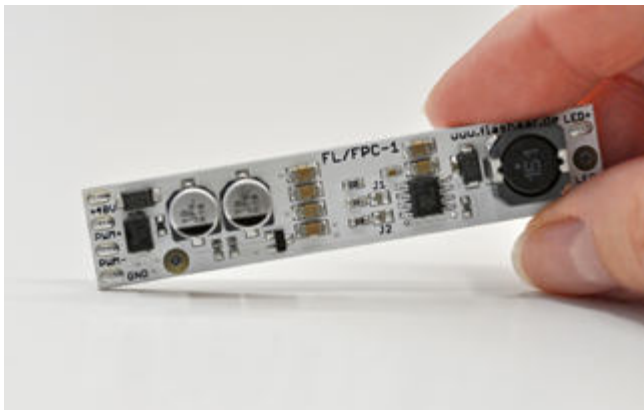

Maßstab 1:1
scale 1:1

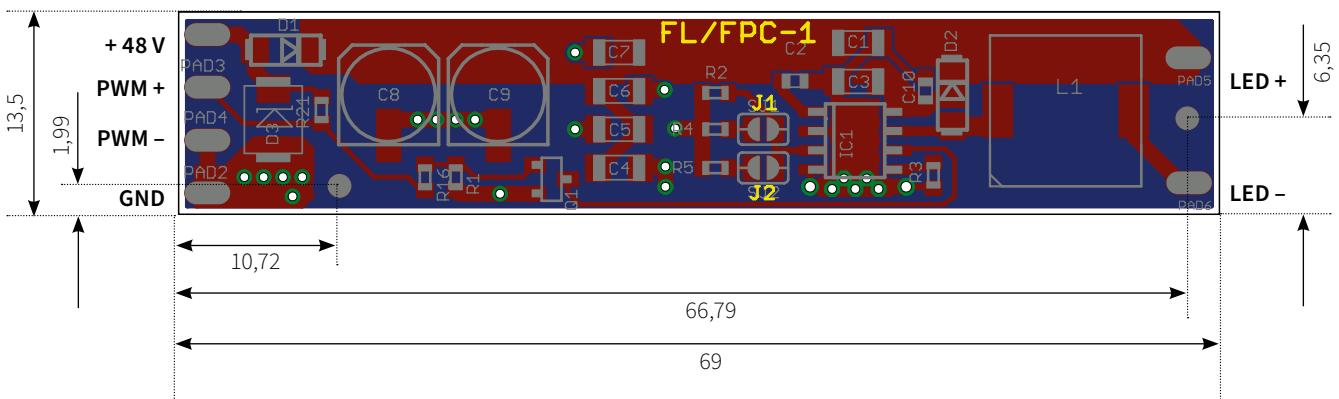
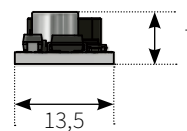

Maßstab 2:1 / Alle Maßangaben in mm.
scale 2:1 / All dimensions in mm.



Technische Daten
technical data

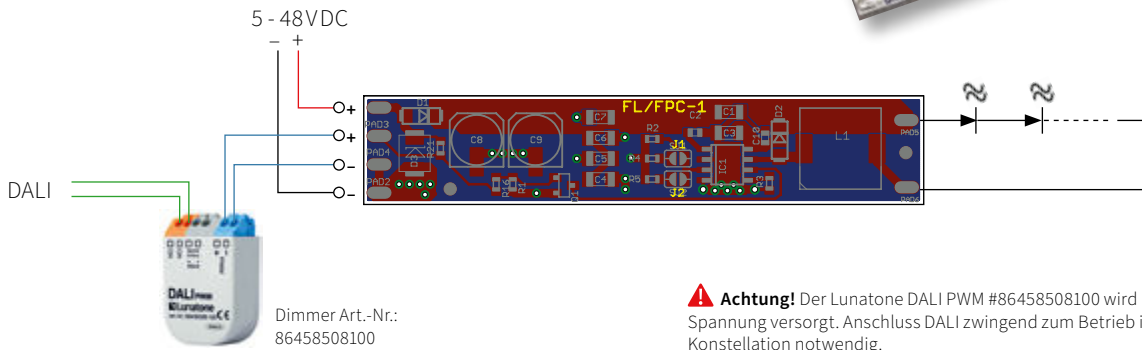

⚠ Achtung! Der Lunatone DALI PWM #86458508100 wird über den DALI Bus mit Spannung versorgt. Anschluss DALI zwingend zum Betrieb in dieser beispielhaften Konstellation notwendig.

Attention! The Lunatone DALI PWM #86458508100 is supplied with voltage via the DALI bus. DALI connection is absolutely necessary for operation in this exemplary constellation.

Alle Maßangaben in mm. All dimensions in mm.

Betriebsart operating mode	Konstantstrom constant current
Eingangsspannung [V] input voltage	5-48V DC
Ausgangsspannung [V] output voltage	max. 48V DC
U PWM+	max. 48V DC
Ausgangsstrom einstellbar [mA] output current adjustable	350/500/700 mA
Lötjumper soldering jumper	Offen open 350 mA Brücke bridge J1 500 mA Brücke bridge J1+J2 700 mA
Standby-Verbrauch* standby-consumption*	U _{in} =48V 1,83 mA U _{in} =24V 1,46 mA U _{in} =12V 1,28 mA
Verpolschutz reverse polarity protection	ja yes
Ausgang kurzschlussfest** output short-circuit proof**	ja yes
PWM+ Schaltschwelle PWM+ switching threshold	> 2V OFF < 2V ON
PWM+ max. Spannung PWM+ max. voltage	max. 48V DC
max. PWM-Frequenz*** max. PWM-frequency***	Zur maximalen PWM Frequenz gibt es keine allgemeingültigen Daten (siehe Absatz 7.3.4 PWM Dimming Control). There is no generally valid data on the maximum PWM frequency. (see paragraph 7.3.4 PWM Dimming Control).

***Dieser Strom setzt sich aus der Standby Stromaufnahme des LM3414HV zusammen (typ. 1,15mA) und dem Strom über die Widerstände R21, R16 und R1 bzw. Transistor Q1. Das ist eine Standby Leistung bei 48V von 0,088W (siehe Seite 2)

***Besonderheit: Im Betrieb kann es je nach LED am Ausgang zu einem Restglimmen kommen. Lösung: 100k Ohm Widerstand parallel am Ausgang

***Bei der PicoSpot Platine wird der LM3414HV zur Stromregulierung verwendet. Die Maximalfrequenz ist von der gewünschten Auflösung des LED Stromes abhängig. Das bedeutet, dass bei hoher PWM Frequenz der LED Strom in weniger Stufen einstellbar ist. Bei 500 Hz PWM Frequenz ist eine LED Strom Auflösung von etwa 1000 Stufen möglich.
Der untere Schwellwert der PWM Spannung liegt rechnerisch bei ca. 2V.

***This current is made up of the standby current consumption of the (typ. 1,15mA) and the current across the resistors R21, R16 and R1 or transistor Q1. This is a standby power at 48 V of 0.088 W (see page 2)

***Special feature: During operation, there may be a residual glow at the output depending on the LED. Solution: 100 k Ohm resistor in parallel at the output.

***The LM3414HV is used for current regulation on the PicoSpot board. The maximum frequency depends on the desired resolution of the LED current. This means that at high PWM frequency the LED current is adjustable in fewer steps. At 500 Hz PWM frequency, an LED current resolution of about 1000 steps is possible.
The lower threshold value of the PWM voltage is calculated at approx. 2V.





NauticProfil® Sonderanfertigungen

NauticProfil® custom-made products

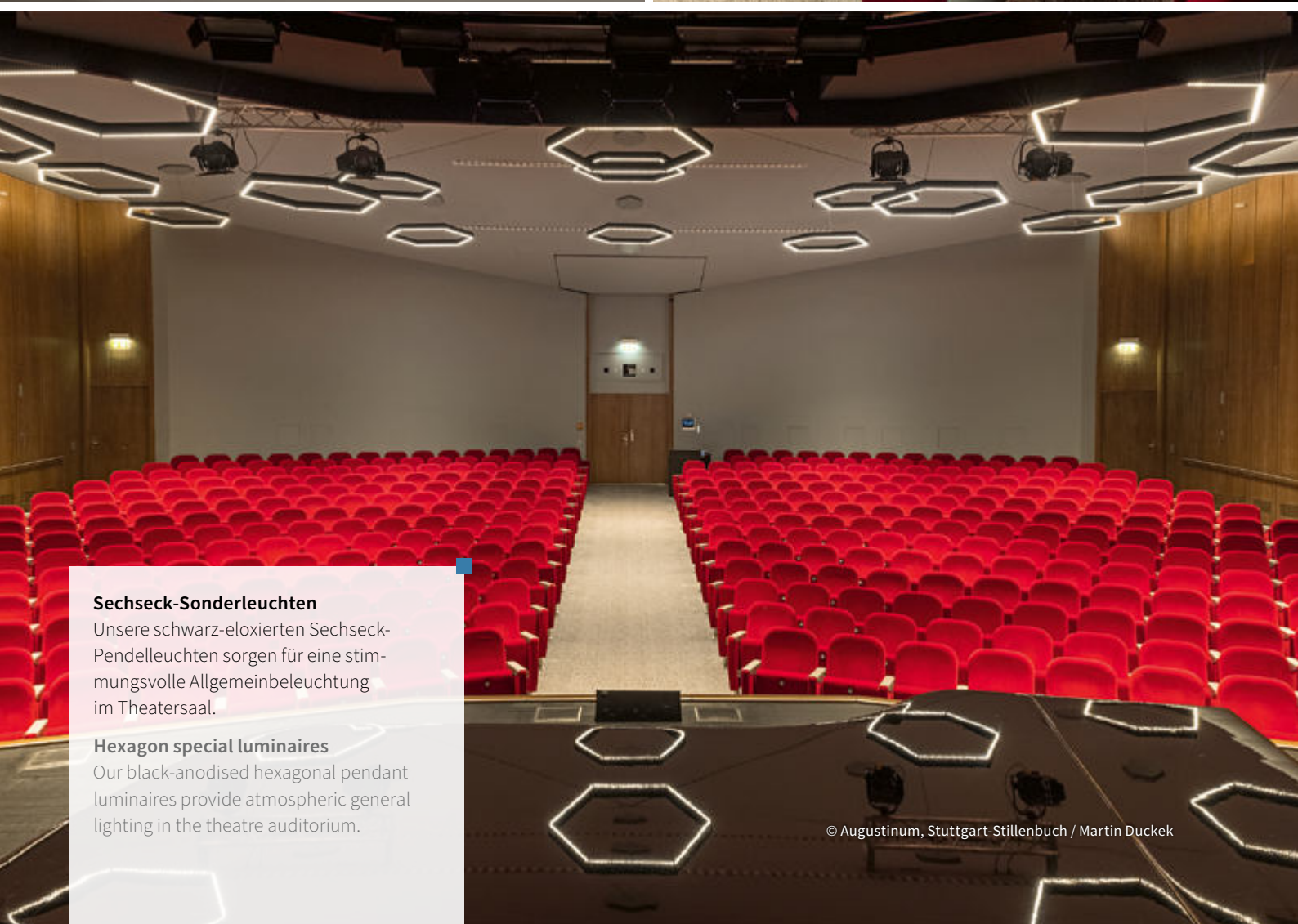
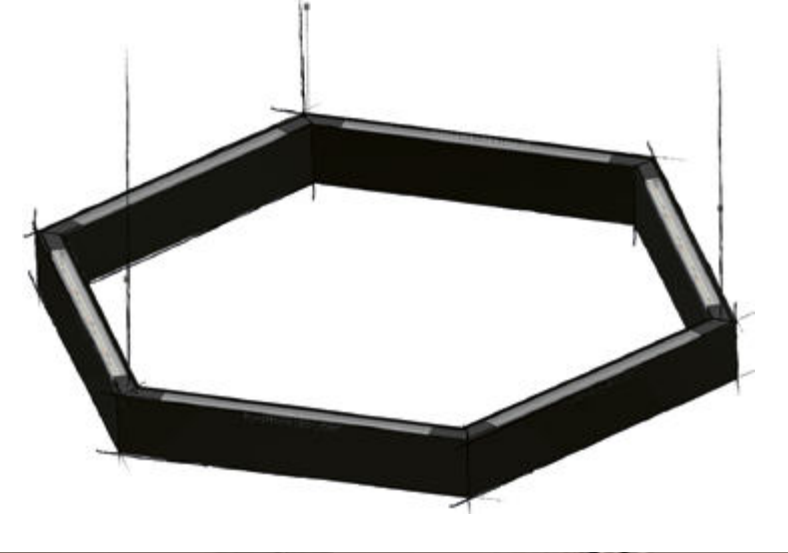

Sechseck-Sonderleuchten

Unsere schwarz-eloxierten Sechseck-Pendelleuchten sorgen für eine stimmungsvolle Allgemeinbeleuchtung im Theatersaal.

Hexagon special luminaires

Our black-anodised hexagonal pendant luminaires provide atmospheric general lighting in the theatre auditorium.

Mehr als nur Standard – FLASHAAR® Sonderleuchten

more than just standard – FLASHAAR® special lights

Neben unseren bewährten und vielseitigen Lichtsystemen planen und realisieren wir mit Ihnen in gleicher Weise auch maßgeschneiderte und formvollendete Lichtlösungen, passend für jede Situation.

Der Wille etwas „Besonderes“ zu schaffen, ergibt sich aus schlichter Notwendigkeit und aus Ihrer Kreativität heraus. Unsere Aufgabe hierbei ist die technische und konstruktive Umsetzung. Alle handgefertigten Sonderleuchten sind genauso einzigartig wie Ihre Projekte. Der Fantasie sind keine Grenzen gesetzt.

Die Leuchten können funktional oder emotional geprägt, minimalistisch oder raumgreifend, ein Unikat oder Kleinstserien sein. Die Produktion einer Sonderleuchte ist immer wieder etwas ganz Besonderes. Nach Möglichkeit wird jede notwendige Komponente für den Zusammenbau der Sonderleuchte auch hier bei uns am Standort in Bingen gefertigt. Ist dies einmal nicht möglich, so greifen wir auf unsere langjährigen und zuverlässigen Lieferanten zurück.

In addition to our proven and versatile lighting systems, we also plan and realise customised and perfectly shaped lighting solutions with you in the same way, suitable for every situation.

The will to create something “special” arises from a simple necessity and from your creativity. Our task here is the technical and constructive implementation. All handcrafted special luminaires are just as unique as your projects. There are no limits to your imagination.

The luminaires can be functional or emotional, minimalist or expansive, one-of-a-kind or small series. The production of a custom luminaire is always something very special. If possible, every component required for the assembly of the special luminaire is also manufactured here at our site in Bingen. If this is not possible, we fall back on our long-standing and reliable suppliers.

1

KUNDENWUNSCH

Das NauticProfil® System bietet nahezu unbegrenzte Kombinationsmöglichkeiten. Somit sind wir in der Lage, dem Kundenwunsch in allen Aspekten gerecht zu werden.

CUSTOMER REQUESTS

The possibilities of combining our NauticProfil® system are almost unlimited. Thus, we are able to meet customer requirements in all aspects.

2

BERATUNG

Eine Beratung, die nichts dem Zufall überlässt. Für die einwandfreie Realisierung Ihres Projektes sichten, prüfen und bewerten wir alle relevanten Faktoren. Dies umfasst z. B. Machbarkeits- und Konzeptstudien sowie Licht- und Steuerungstechnik.

CONSULTING

A consultation which leaves nothing to chance. For the optimal realisation of your project, we screen, analyse and evaluate all relevant factors as feasibility studies, concept surveys, light and control technology etc.

3

PROTOTYPING

Damit am Ende alles passt. Für die optimale Umsetzung Ihrer Wünsche planen, simulieren und koordinieren wir alle relevanten Schnittstellen, von der Licht- und Elektroplanung bis hin zu Zulieferangeboten und Projektkoordination.

PROTOTYPING

So that in the end everything comes together. In order to optimally realise your wishes, we plan, simulate and coordinate all relevant liaisons from light and electrical planning until to project coordination.

4

PRODUKTION/LIEFERUNG

Alles für Ihr Wunschlicht. Für ein individuelles Lichtdesign produzieren, prüfen, kommissionieren und liefern wir alle notwendigen Produkte, auch von kooperierenden namhaften Herstellern. Zuverlässig aus einer Hand.

PRODUCTION/DELIVERY

Everything for your desired illumination. For a unique illumination design, we analyse, produce, commission and deliver all necessary products, including those from cooperating wellknown manufacturers. Dependably from one source.

Individuelle Fertigung - Made in Bingen am Rhein

individual production - Made in Bingen am Rhein

Projektspezifische Leuchten sind Standard bei FLASHAAR®. Für zahlreiche Anwendungen und namhafte OEM-Kunden entwickeln wir Wand- und Deckenleuchten, Strahler und Profile für Innen- und Außenanwendungen.

Project-specific luminaires are standard at FLASHAAR®. We develop wall and ceiling luminaires, spotlights and profiles for indoor and outdoor applications for numerous applications and renowned OEM customers.

NauticProfil® Profilfarben

NauticProfil® Focus: profile colours

Durch individuelle und hochwertige Eloxale oder Pulverbeschichtungen lassen sich die FLASHAAR® NauticProfil® Systeme farblich auf jedes Raumkonzept abstimmen.

Neben der Standardfarbe Alu eloxiert (E6EV1) und Schwarz matt eloxiert (E6C14) sind weitere Farben für Profile, NP Leuchteneinsätze und Endplatten erhältlich.

Eloxierte Oberflächen gewährleisten einen sehr hohen Schutz gegen mechanische Beanspruchung und bieten eine ausgezeichnete Widerstandsfähigkeit gegen Witterung und Korrosion

With individual and high-quality anodising or powder coating, the FLASHAAR® NauticProfil® systems can be colour-coordinated with any room concept.

In addition to the standard colour anodised aluminium (E6EV1) and matt anodised black (E6C14), other colours are available for profiles, NP luminaire inserts and end plates.

Anodised surfaces ensure a very high level of protection against mechanical stress and offer excellent resistance to weathering and corrosion.

Auf Anfrage liefern wir die Systemelemente auch in sämtlichen individuellen RAL- und Eloxalfarben.

On request, we also supply the system elements in all individual RAL and anodised colours.



alu anodized E6EV1



RAL 9016 traffic white fine structure (powdered)



black anodized E6C14



nickel satin (anodized)



orange red (anodized)



yellow green (anodized)



royal blue (anodized)



anthracite mica (powdered)



carbon grey mica (powdered)



silver grey mica (powdered)

Sonderfarben auf Anfrage!
Special colours on request!

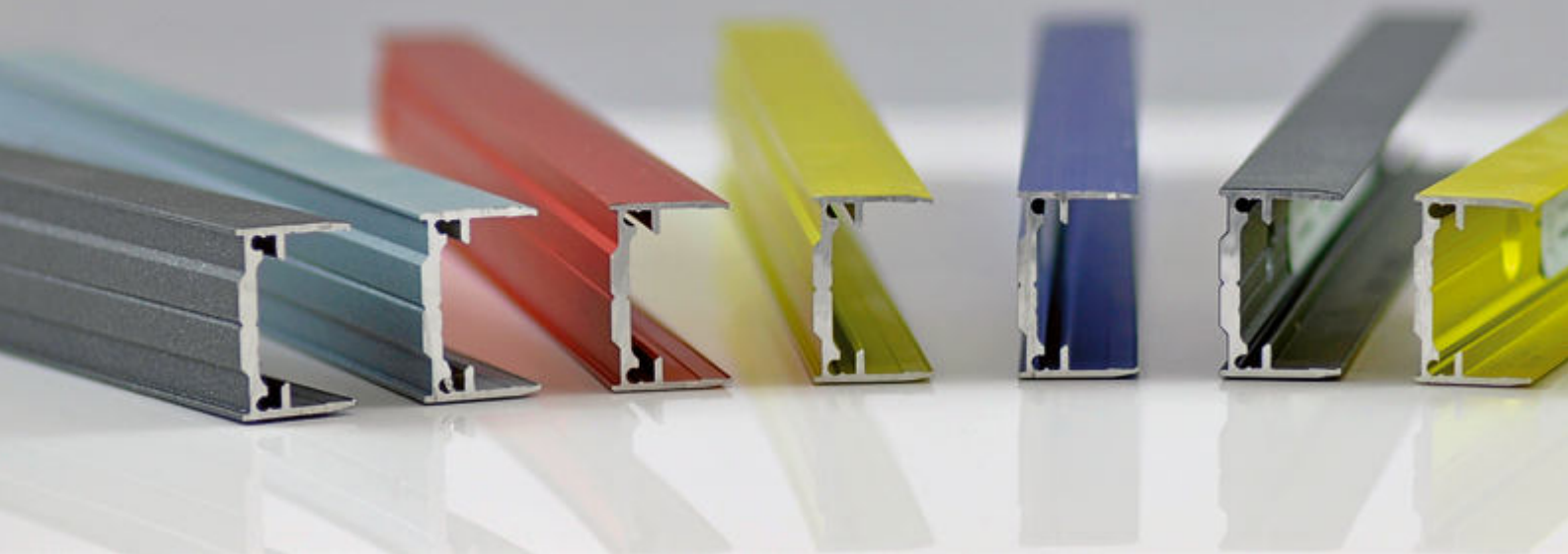

Ecklösungen corner solutions

Spezielle Ecklösungen für alle Profile und LED-Einsätze sind mit Lichtabstrahlung nach innen, außen und oben/unten erhältlich.

Special corner solutions for all profiles and LED light inserts are available to direct the light in or out and up or down.

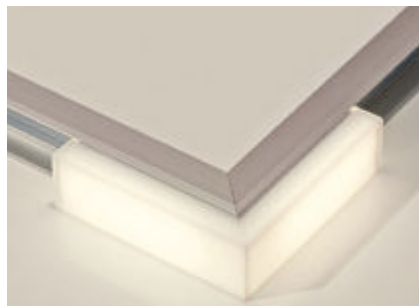

Zubehör NP Montageprofile accessories NP Mounting profiles

Sets zur Abhängung der Profile als Pendelleuchten und zahlreiches Montagezubehör finden Sie auf den einzelnen Profilsseiten und im Katalog ab Seite 198.

You'll find sets for hanging the profiles as pendant luminaires and numerous installation accessories on the individual profile pages and from Page 198.

FLASHAAR® PremiumCoating patentiert für das NauticProfil®

FLASHAAR® PremiumCoating patented for the NauticProfile®

Zum Schutz vor Feuchtigkeit, Staub, Vibration, mechanischer Beanspruchung und anderen schädlichen Umwelteinflüssen vergießen wir seit vielen Jahren unsere Leuchten mit einem transparenten Polyurethan (PU). Bisher war es nicht möglich, vergossene und unvergossene Leuchteneinsätze mit exakt dem gleichen Farbort zu liefern.

Die optischen Eigenschaften unseres Harzes haben wir stets sorgfältig bewertet, um sicherzustellen, dass unser PU die Farbeigenschaften der LED so weit wie möglich bewahrt. Dennoch haben wir beim Messen der Farbtemperaturen der LED nach dem Verguss festgestellt, dass es eine Verschiebung in der Farbtemperatur gibt. Sie driftet von einem warmen zu einem kühleren Farbort. Der Farbdrift ist umso größer, je höher die Farbtemperatur der LED vor dem Verguss ist.

Beispielhafte Farbverschiebungen der LED:

2200K → 2700K; 2400K → 3000K, 2700K → 3500K
3000K → 4500K; 4000K → 6000K

Speziell für herausfordernde Projekte, die beispielsweise eine durchgehende Lichtlinie aus dem Außenraum in den Innenraum erfordern, haben wir ein neues, ergänzendes Vergussverfahren entwickelt.

FLASHAAR® PremiumCoating macht den Unterschied

FLASHAAR® PremiumCoating makes the difference

Bei unserem herkömmlichen PU-Überdeckungsverguss wird das Licht erst nach dem Durchdringen des Polyurethan abgestrahlt. Dies führt zu der unerwünschten, deutlich sichtbaren Farbortverschiebung. Verantwortlich dafür ist die Änderung des Brechungsindex am Übergang der Phosphorschicht in PU anstatt wie zuvor in Luft.

Unser patentiertes FLASHAAR® PremiumCoating ist einfach und genial zugleich. Vor dem PU-Verguss klipsen wir die neue IP Schutzabdeckung der Länge nach über unsere hochwertigen LED-Alukernplatinen. Dieses winzige Cover überdeckt die LEDs und verhindert somit einen direkten Kontakt mit dem Gießharz, bzw. unserem PU. Der Brechungsindex ist unverändert, der Farbort bleibt konstant.

Die mittels FLASHAAR® PremiumCoating vergossenen Leuchteneinsätze sind zudem optimiert auf die Kombination mit weiß eingefärbten Covern. Ein absolut homogenes, einheitliches lineares Erscheinungsbild, egal ob vergossen oder unvergossen, ist mit dieser Technologie garantiert.

To protect against moisture, dust, vibration, mechanical stress and other harmful environmental influences, we have been encapsulating our luminaires with a transparent polyurethane (PU) for many years. Until now, it has not been possible to deliver encapsulated and non-encapsulated light inserts with exactly the same colour temperature.

We have always carefully evaluated the optical properties of our resin to ensure that our PU retains the colour properties of the LED as much as possible. Nevertheless, when measuring the colour temperatures of the LED after encapsulation, we noticed a shift in the colour temperature. In this case, it drifts from a warm to a cooler colour temperature. The higher the colour temperature before encapsulating, the greater the colour shift.

Exemplary colour shifts of the LED:

2200K → 2700K; 2400K → 3000K, 2700K → 3500K
3000K → 4500K; 4000K → 6000K

Especially for challenging projects we have developed a new, additional encapsulating process. For example, if you need a continuous line of light from the outside into the interior.

With our conventional PU encapsulation, the light is only emitted after penetrating the polyurethane. This results in the undesirable, clearly visible shift in the colour temperature. This is due to the change in the refractive index at the transition of the phosphorus layer into PU instead of into air as before.

Our patented FLASHAAR® PremiumCoating is simple and ingenious at the same time. Before being encapsulated, we clip the new IP protection cover lengthwise over our high-quality LED aluminum core boards. This tiny cover protects the LED and prevents direct contact with the resin or our PU coating. The refractive index is unchanged, the colour location remains constant.

The luminaires, which are encapsulated with our FLASHAAR® PremiumCoating have been specially optimized for the use of white coloured covers. This technology guarantees an absolutely homogeneous, uniform linear appearance, whether encapsulated or not.



IP65 PremiumCoating

- keine Farbortverschiebung
- nahezu identischer Lumenstrom (Licht-Output)
- no colour location shift
- almost identical lumen flux (light output)

Bestellnummer
item number

FLNP/IP65-COAT/PREM

Technische Daten
technical data

suitable for the following LED lines:
NP Mayflower, NP Sta. Maria, NP Victory, NP Navigator,
NP Jago, NP Nova
optimized for the covers: round, square, flat
in the colours: transparent, frosted, white
in the materials: PMMA or Polycarbonat
degree of protection: IP65
(higher protection classes on request: IP66, IP67, IP69)

PU-Verguss
IP ProtectionCover
LED-Alukernplatten
Einschubprofil

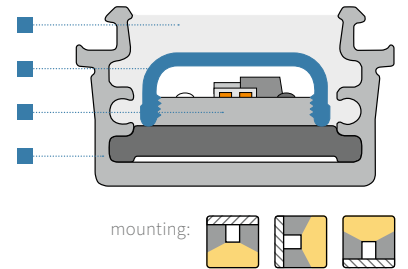

characteristics: IP65





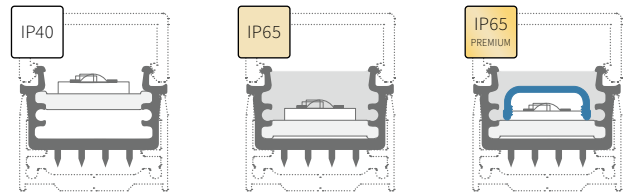

Beispiel: Vergleich Farbtemperatur und Lumenstrom bei verschiedenen Schutzarten

example: comparison of colour temperature and lumen output for different protection types

⚠ Achtung! Ein Leuchteneinsatz mit IP65- oder IP65 Premium-Verguss ist ausschließlich in den Längen von 112 mm bis 1008 mm realisierbar.

⚠ Attention! A light insert with IP65 or IP65 Premium encapsulation can only be realised in lengths from 112 mm to 1008 mm.



vermessene Leuchte* measured luminaire	IP40	IP65	IP65 Premium
Beispiel/ Example: NP Navigator-3; 2700 K NP/L1C/G1/03F/L1C/G1/0510/827	2700 K 1582 lm/m // 2738 K	2700 K 1058 lm/m // 3738 K //+1000 K	2700 K 1336 lm/m // 2738 K
   			

* Alle Angaben unterliegen den Messtoleranzen. All specifications are subject to measurement tolerances.

FLASHAAR® ILAF

Unsere neue asymmetrische Linearlinse ILAF – entwickelt für eine perfekte Handlaufbeleuchtung

Speziell für Projekte, die eine hocheffiziente und vandalensichere Handlaufbeleuchtung erfordern, haben wir für unser NauticProfil® System eine neue Linearlinse entwickelt: die **ILAF**.

Bisher lag der Fokus bei der Integration von linearen Lichtprofilsystemen in Handläufen auf einer einfachen Verkabelung, der schnellen Montage und guter Wartungsfreundlichkeit.

Die ILAF ist im NauticProfil® Leuchteinsatz integriert und ist prädestiniert für die Beleuchtung von Treppen, Gehwegen oder Brücken. Sie ist leicht gefrostet und der Lichtaustritt wird durch sie gezielt asymmetrisch gelenkt. Während eine Seite blendfrei und gleichmäßig ausgeleuchtet wird, tritt auf der anderen Seite keine störendes Licht aus. Bei Brücken können zum Beispiel somit ungewünschte Reflektionen auf darunter liegenden Wasser- oder Straßenflächen vermieden werden.

Die Kombination von einem abschließenden eckigen Cover sowie unserem patentierten FLASHAAR® PremiumCoating macht den Einsatz der ILAF komplett. Der Vorteil – die Haptik im Handlauf wird nicht durch eine aus dem Nutrohr herausragende Linearlinse gestört. Das eckige Cover gibt dem Handlauf einen glatten und sauberen Abschluss der Nut. Die LED-Beleuchtung ist, dank unserem FLASHAAR® PremiumCoating wettergeschützt und sicher vor Vandalismus, gleichzeitig ist eine absolute Farborttreue der LED garantiert.

Our new asymmetric linear lens ILAF – Designed for perfect handrail lighting

Especially for projects that require highly efficient and vandal-proof handrail lighting, we have developed a new linear lens for our NauticProfil® system: the **ILAF**.

Until now, the focus when integrating linear light profile systems in handrails has been on simple wiring, quick installation and good ease of maintenance.

The ILAF is integrated in the NP light insert and is predestined for the illumination of stairs, walkways or bridges. It is slightly frosted and the light emission is directed asymmetrically. While one side is illuminated glare-free and uniformly, no disturbing light escapes on the other side. This avoids unwanted reflections on water or road surfaces below, for example on bridges.

The combination of a final angular cover and our patented FLASHAAR® PremiumCoating makes the ILAF complete.

The advantage - the feel in the handrail is not disturbed by a linear lens protruding from the grooved tube. The angular cover gives the handrail a smooth and clean finish to the groove. Thanks to our FLASHAAR® PremiumCoating, the LED lighting is weather-protected and safe from vandalism, at the same time, the absolute colour fidelity of the LED is guaranteed.

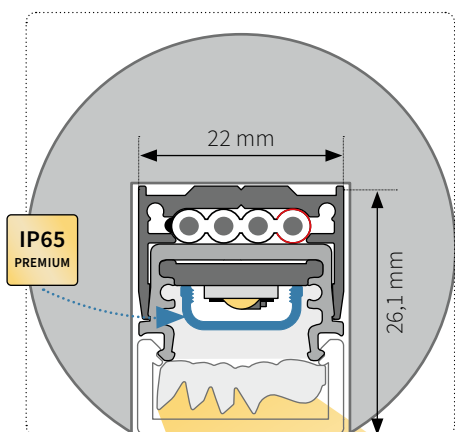

Handlauf mit einer glatten, störfreien Haptik, dank innenliegender Linse - ILAF.

Handrail with a smooth, trouble-free feel, thanks to internal lens - ILAF.

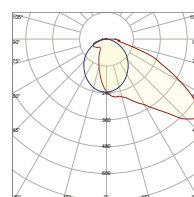
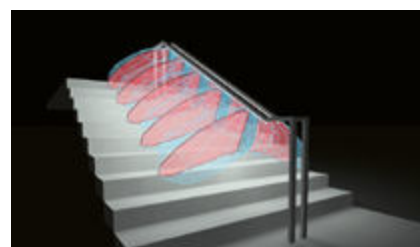

characteristics



mounting



optional



*NP = NauticProfil®

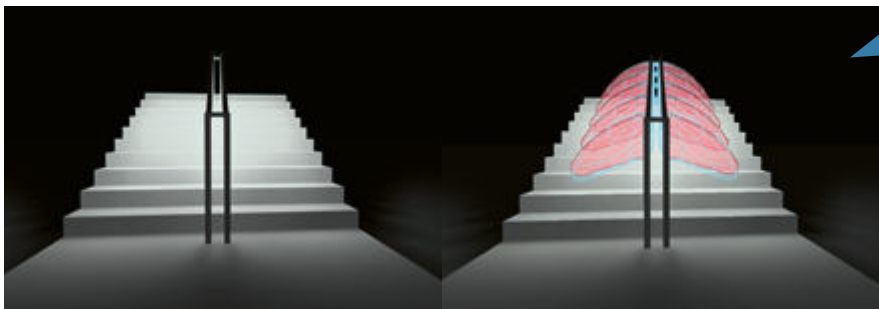

Asymmetrische, blendfreie
und absolut homogene
Lichtverteilung

Asymmetrical, glare-free
and absolutely homogeneous
light distribution

Dank FLASHAAR® PremiumCoating
perfekt für den Einsatz in
Handläufen im Außenbereich.

Perfect for use in outdoor
handrails thanks to
FLASHAAR® PremiumCoating.



Bewährtes kombiniert mit Erfindergeist - Ihre Vorteile im Überblick

tried and tested combined with inventiveness - your advantages at a glance

Im Gegensatz zu sonst häufig eingesetzten Mastleuchten, bieten innovative lineare LED-Linien, die sich direkt im Handlauf befinden, viele Vorteile. Die durchgehend homogene Ausleuchtung der Wege geben ein höheres Gefühl der Sicherheit, verringern das Unfallrisiko und sorgen nebenbei für eine Reduzierung der Energiekosten.

Die ILAF wurde so entwickelt, dass bei einer typischen Handlaufhöhe von 80 cm so viel Licht wie möglich blendfrei in die Tiefe gelangt.

Dank unserer bewährten **Plug&Play** Montage lassen sich die NP Leuchteneinsätze komplett werkzeuglos in die, im Handlauf befindlichen, NP Montageprofile einklicken. Lichtlinien in Längen von über 100m sind, mit nur einer elektrischen Einspeisung, problemlos realisierbar.

Der konsequente Einsatz von hochwertigen Alukernplatten und langlebigen Materialien in unseren NP Leuchteneinsätzen garantiert eine **lange Lebensdauer**, mit über 100.000 Betriebsstunden in der Anwendung.

Schutz der NP Leuchteneinsätze vor Witterung und Vandalismus bieten **hohen Schutzarten**. Mit unserer hauseigenen PU-Vergussanlage können wir diese in IP65, IP66, IP67 und IP69 anbieten

Unsere Cover und Linearlinsen aus PMMA punkten durch eine sehr hohe UV-Beständigkeit. Cover aus Polycarbonat hingegen sind besonders schlagzäh.

Die mittels **FLASHAAR® PremiumCoating** vergossenen Leuchten garantieren eine absolute Farbtreue sowie ein absolut homogenes, gleichmäßiges Erscheinungsbild. Auch niedrige Farbtemperaturen, wie 2200K oder 2700K, sind bei hohen IP-Schutzarten, z.B. in IP66 oder IP67, möglich.

Alle Komponenten sind aufeinander abgestimmt, um eine gleichmäßige Beleuchtung zu gewährleisten und die mutwillige Zerstörung des LED-Handlaufes zu verhindern.

In contrast to the otherwise frequently used post-mounted luminaires, innovative linear LED lines located directly in the handrail offer many advantages. The continuous homogeneous illumination of the pathways gives a greater feeling of safety, reduces the risk of accidents and also ensures a reduction in energy costs.

The ILAF has been developed so that with a typical handrail height of 80 cm, as much light as possible reaches the depth without glare.

Thanks to our proven **Plug&Play** assembly, the NP light inserts can be clicked into the NP mounting profiles in the handrail without any tools. Light lines in lengths of more than 100m can easily be realised with only one electrical feed.

The consistent use of high-quality aluminium core boards and durable materials in our NP light inserts guarantee a **long service life**, with over 100,000 operating hours in use.

Protection of NP luminaire inserts from weather and vandalism offers **high protection ratings**. With our in-house PU potting facility, we can offer these in IP65, IP66, IP67 and IP69.

Our covers and linear lenses made of PMMA score points for their very high UV resistance. Polycarbonate covers, on the other hand, are particularly impact resistant.

The luminaires encapsulated by means of **FLASHAAR® PremiumCoating** guarantee absolute colour fidelity as well as an absolutely homogeneous, uniform appearance. Low colour temperatures, such as 2200K or 2700K, are also possible with high IP protection classes, e.g. in IP66 or IP67.

All components are coordinated with each other to ensure uniform illumination and to prevent the wilful destruction of the LED handrail.



Lahmeyerbrücke Frankfurt a. M.

Die Herausforderung: Realisierung einer durchlaufenden Lichlinie in einem gebogenen Handlauf ohne Unterbrechungen. Eine perfekte Aufgabe für unser NauticProfil® System. LED-Linien von FLASHAAR® leuchten den Weg über die Lahmeyerbrücke gleichmäßig aus und sorgen so für optimale Sicherheit. Eingelassen in die Nut des Handlaufs und jeweils mit weißen Abdeckungen versehen, ergeben die Leuchten ein homogenes und kontinuierliches Erscheinungsbild.

Lahmeyer Bridge Frankfurt a. M.

The challenge: realising a continuous light line in a curved handrail without interruptions. A perfect task for our NauticProfil® system. LED lines from FLASHAAR® evenly illuminate the path across the Lahmeyer Bridge, ensuring optimum safety. Recessed into the groove of the handrail and each fitted with white covers, the luminaires create a homogeneous and continuous appearance.



FLASHAAR® SAPP 1000 / 1500

Maßgeschneiderte Lösung für Klima-Deckensysteme

DE Modernes Bauen im Einklang mit Umwelt und Klimaschutz stellt uns immer wieder vor neue Herausforderungen. Kühl- und Heizfunktion sollen im Einklang mit ästhetischen, lichttechnischen und akustischen Ansprüchen bestmöglich in technische oder intelligente Decken integriert werden.

Die **FLASHAAR® SAPP 1000/1500** bietet genau hierfür eine maßgeschneiderte Lösung für verschiedene Klima-Deckensysteme an.

Lange Lichtlinien, ob mit gerichteter oder diffuser Abstrahlung, mit einem Farbwiedergabewert von CRI > 90, fügen sich perfekt in die Längsachse der Decken-Paneele ein.

Damit ist die **FLASHAAR® SAPP 1000/1500** prädestiniert für hochwertige Allgemeinbeleuchtungen in Büros, Fachgeschäften und repräsentativen Räumen sowie immer dann, wenn Farben besonders brillant und naturgetreu wiedergegeben werden sollen.

Tailor-made solution for climate-conditioned ceiling systems

EN Modern construction in harmony with the environment and climate protection always presents us with new challenges. Correctly integrating the cooling and heating function in technical or intelligent ceilings in accordance with the aesthetic, lighting and acoustic requirements, is not always simple.

The **FLASHAAR® SAPP 1000/1500** offers a tailor-made solution for various climate-control ceiling systems.

Long lines of light, whether with directed or diffuse lighting, with a CRI of more than 90, fit perfectly in to the longitudinal axis of the ceiling panels.

This makes the **FLASHAAR® SAPP 1000/1500** ideal for high-quality general lighting in offices, retail outlets and showrooms as well as whenever the true colours need to be brilliantly and naturally represented.

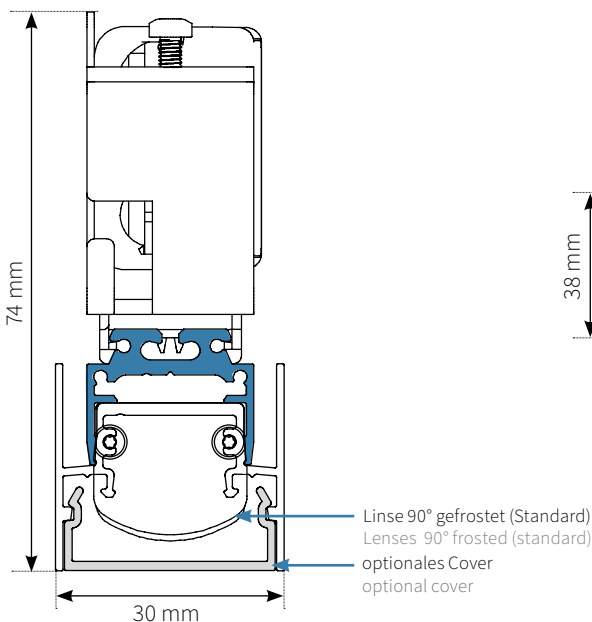

Maßstab/scale 1:1

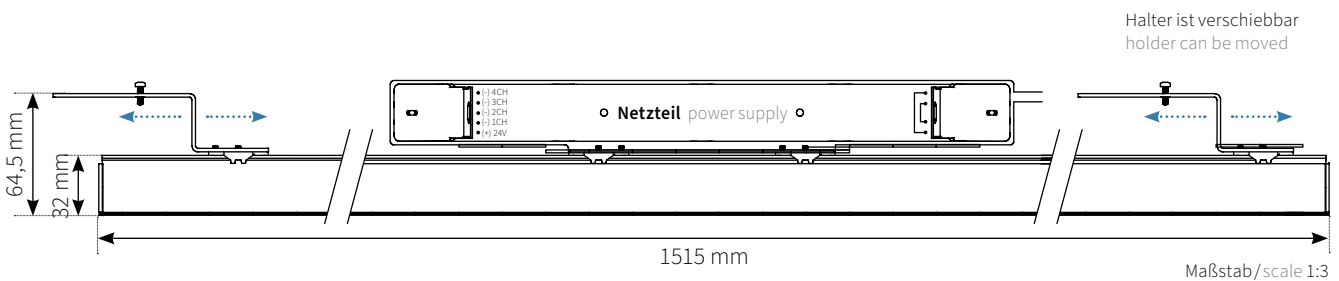
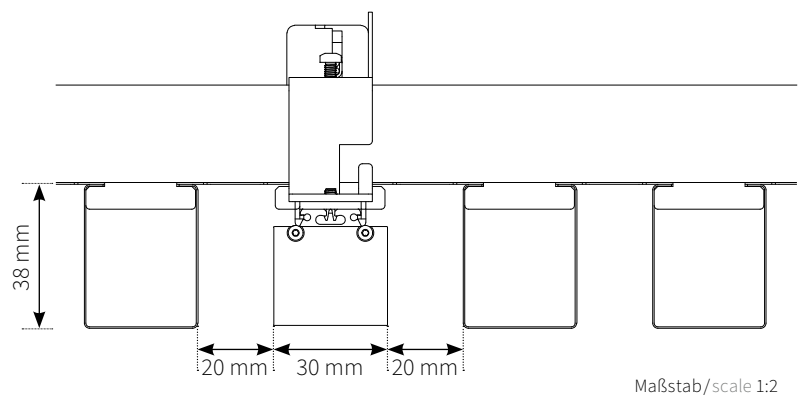

 ... /ALA
alu anodized
(standard)
E6EV1

 ... /BA
black
anodized
E6C14

 ... /TWP
RAL 9016 traffic
white fine structure
(powdered)

Sonderfarben auf Anfrage! Special colours on request!

Bitte bei NP Profil- und Endplatten-Bestellung die Art.Nr. um die gewünschte Farbe ergänzen.
Please state the required colour with the article number when ordering NP profiles



characteristics



dimming

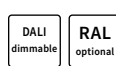

optional



mounting





© Bürgerhaus, Müllheim / Bernhard Tränkle

Bestellnummer
item number

FLNP/SAPP1 / 1508 / 9 27 / L9 F

Technische Daten
technical data

Bsp. Leuchteneinsatz NP Jago, 24V
ex. light insert NP Jago, 24V

LED-serie:	Bsp.: NP Jago, 24 VDC	dimmable:	Casambi, optional DALI
cover/lenses:	CRT, CRF, CRW, CST, CSF, CSW, CSG, CFT, CFF, CFW lenses 90°, 60°, 30°, 15°, LAF-2 asymmetric (standard 90° frosted)	length dividing matrix:	50 mm
nominal voltage:	220-240VAC; 50-60 Hz	LED pitch:	7,1 mm, 140 LEDs/m
nominal wattage:	1000 mm: ca. 24W 1500 mm: ca. 36W	integrated dimmer:	LVM40E-24T; ERP (on/off) or LCA60W24V; DALI DT6; Tridonic or OTi BLE 80/220-240/24V; 1-4CH; Casambi
photometric code:	9XX/339; CRI typ. 94	lengths:	1000 mm or 1500 mm
luminous efficiency [typ]:	100 lm/W	protection type:	IP40
LED service life:	L80/B10 >100 000 h L90/B10 >60 000 h	protection class:	2
		weight of the luminaire:	1008 mm: ca. 1000 g 1508 mm: ca. 1300 g

Farbtemperatur und Lumenstrom
colour temperature and luminous flux

Farbtemperatur colour temperature	WW 2700 K	WW 3000 K	NW 4000 K
CRI typ.	94	94	94
Lumenstrom* luminous flux*	ca. 2200 lm/m ca. 3400 lm/1,5m	ca. 2200 lm/m ca. 3400 lm/1,5m	ca. 2663 lm/m ca. 3900 lm/1,5m
	927	930	940

* Alle Angaben zum Lumenstrom beziehen sich auf das Leuchtmedium.
* All information about the luminous flux refers to the light source.

Varianten
variants

1)	FLNP/SAPP1/1515/927/L9F	FLASHAAR® SAPP 1500, ECO	# LVM40E-24T; ERP
2)	FLNP/SAPP2/1515/927/L9F	FLASHAAR® SAPP 1500, ECO DALI	# LCA35W24V; Tridonic
3)	FLNP/SAPP3/1515/927/L9F	FLASHAAR® SAPP 1500, PREMIUM CASAMBI	# OTi BLE80/220-240/24V, Osram
4)	FLNP/SAPP1/1015/927/L9F	FLASHAAR® SAPP 1000, ECO	# LVM40E-24T; ERP
5)	FLNP/SAPP2/1015/927/L9F	FLASHAAR® SAPP 1000, ECO DALI	# LCA35W24V; Tridonic
6)	FLNP/SAPP3/1015/927/L9F	FLASHAAR® SAPP 1000, PREMIUM CASAMBI	# OTi BLE80/220-240/24V, Osram

Montagehinweis installation note

DE Die FLASHAAR® SAPP 1000/1500 wurde speziell für SAPP Decken konstruiert und wird mithilfe von Montagehaltern direkt in die Decke befestigt.

Hierfür montieren Sie die aus dem Zubehör ausgewählten Montagehalter an der FLASHAAR® SAPP 1000/1500 (drücken - klicken - fertig).

Nutzen Sie dafür die vormontierten Montageclips 0° (FL/CLIP-0/0/001) auf den Montagehaltern. Stellen Sie sicher, dass die Montageclips hörbar eingeklickt sind und montieren Sie die Leuchte in der gewünschten Position.

EN The FLASHAAR® SAPP 1000/1500 was specially developed for SAPP ceilings and is fixed directly into the ceiling using mounting brackets.

To do this, attach the bracket selected from the accessories for the FLASHAAR® SAPP 1000/1500. (press - click - done)

For this use the supplied mounting clips 0° (FL/CLIP-0/0/001) on the mounting brackets. Make sure that the mounting clips are clicked audibly and mount the lamp in the desired position.

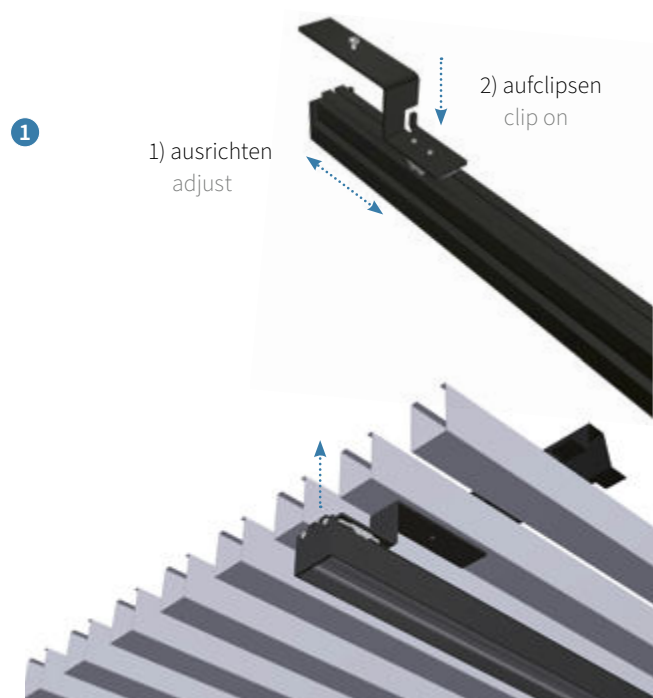
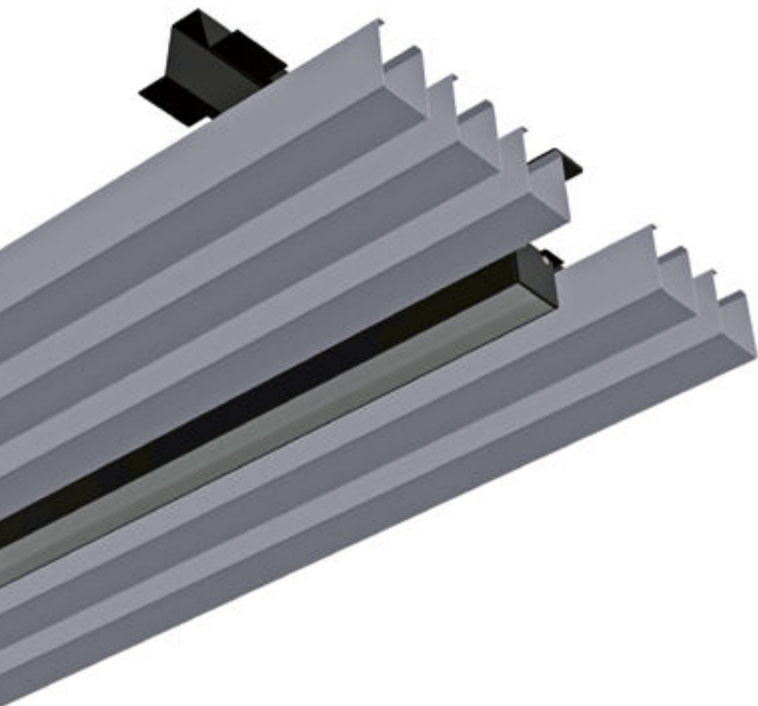

1 Montagehalter mit Montageclips auf der Rückseite der Leuchte einclipsen und Abstände der Halter entsprechend dem Abstand der Querträger ausrichten.

Clip the mounting bracket with mounting clips on the back of the lamp and align the distance between the brackets according to the distance between the cross beams.

2 3 Montagehalter über die Querträger der Decke schieben.

Slide the mounting bracket over the cross beams of the ceiling.







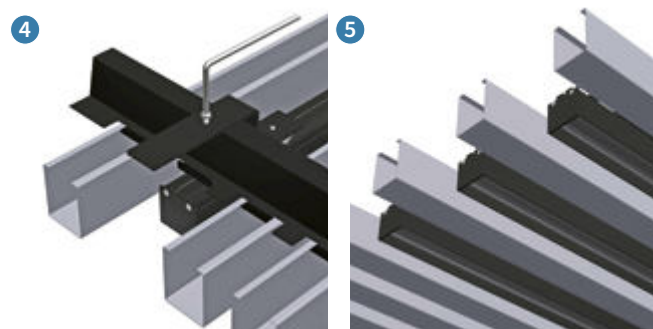
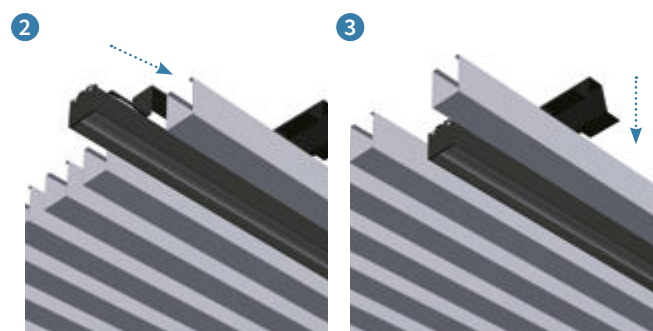

4 Sicherungsschraube festschrauben.

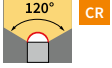
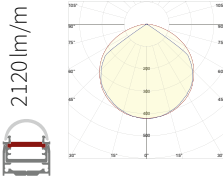
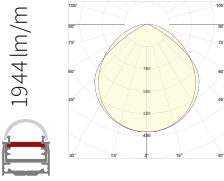
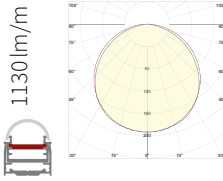
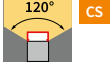
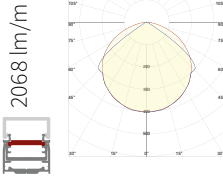
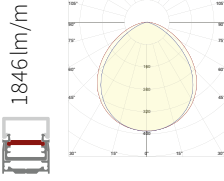
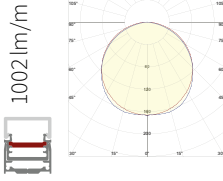
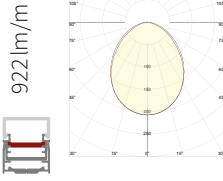
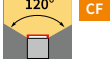
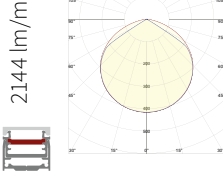
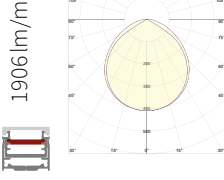
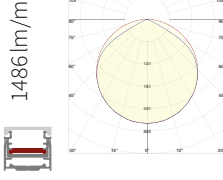
Fix the locking screw.

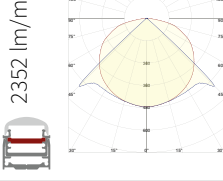
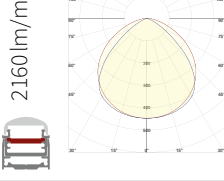
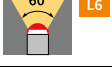
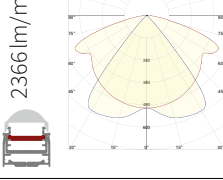
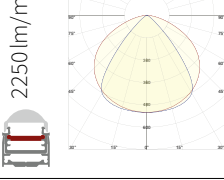
5 Elektrischen Anschluss vornehmen.

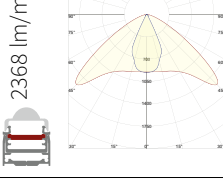
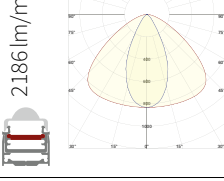
Connect the power supply.

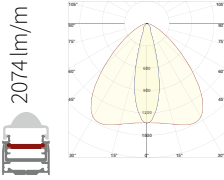
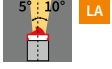
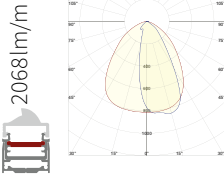

covers & lenses	T	F	W	G	M
cover round 120° 	2120 lm/m 	1944 lm/m 	1130 lm/m 		
cover square 120° 	2068 lm/m 	1846 lm/m 	1002 lm/m 	922 lm/m 	
cover flat 120° 	2144 lm/m 	1906 lm/m 	1486 lm/m 		
lens 90° 	2352 lm/m 	2160 lm/m 			
lens 60° 	2366 lm/m 	2250 lm/m 			
lens 30° 	2368 lm/m 	2186 lm/m 			
lens 15° 		2074 lm/m 			
lens LAF-2 asymmetric 		2068 lm/m 			
lens ILAF asymmetric (IP65) 					
<p>Alle Werte in der Tabelle gemessen bei 2700 K. Messwerte unterliegen den typischen Toleranzen. Andere Konfigurationen erhalten Sie auf Anfrage. All values in the table measured at 2700 K. Measured values are subject to the typical tolerances. Other configurations are available on request.</p> <p>Alle lichttechnischen Daten – vermessen im FLASHAAR® Lichtlabor – finden Sie unter flashaar.de im Download-Bereich. Alle optischen und elektrischen Daten haben eine Toleranz von +/- 10%. All photometric data – measured in FLASHAAR's light laboratory – available at flashaar.de/en in the download area. All optical and electrical data have a tolerance of +/- 10%.</p> <p>Messdaten für IP65 / IP65 Premium auf Anfrage. Measurement data for IP65 / IP65 Premium on request.</p>					











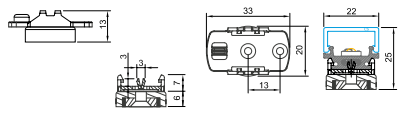

NauticProfil® Zubehör
NauticProfil® accessories

Magnetische Montageclips

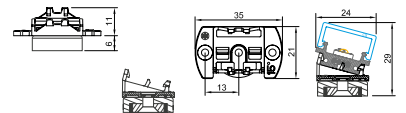
magnetic mounting clips

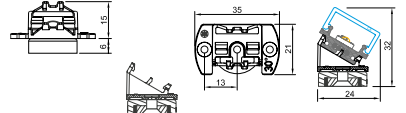

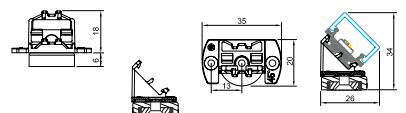

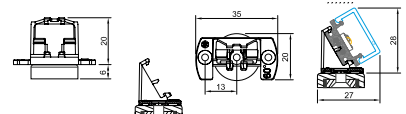

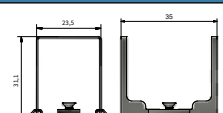

Vielseitig verwendbar, einfachste Montage – die Montageclips sind hier mit starken Dauermagneten kombiniert, um die Profile NP S2, NP R1 und NP R2 auf allen magnetischen Flächen, wie z. B. Stahlträgern und Verblendungen, dauerhaft zu befestigen.

Versatile, easy mounting – the mounting clips are combined with strong permanent magnets to permanently attach the NP S2, NP R1 and NP R2 profiles to all magnetic surfaces such as steel girders and facings.

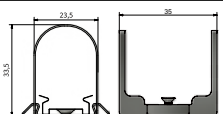
item	item number	product	detail	drawing
	FL/MCLIP-1/0/001	Magnetischer Montageclip 0° mit Reibzapfen magnetic mounting clip 0° with stud	33 x 20 x 13 mm; Magnet & Kunststoff magnet & plastic PBT	
	FL/MCLIP-1/15/001	Magnetischer Montageclip 15° mit Reibzapfen magnetic mounting clip 15° with stud	35 x 21 x 17 mm; Magnet & Kunststoff magnet & plastic PBT	
	FL/MCLIP-1/30/001	Magnetischer Montageclip 30° mit Reibzapfen magnetic mounting clip 30° with stud	35 x 21 x 21 mm; Magnet & Kunststoff magnet & plastic PBT	
	FL/MCLIP-1/45/001	Magnetischer Montageclip 45° mit Reibzapfen magnetic mounting clip 45° with stud	35 x 20 x 24 mm; Magnet & Kunststoff magnet & plastic PBT	
	FL/MCLIP-1/60/001	Magnetischer Montageclip 60° mit Reibzapfen magnetic mounting clip 60° with stud	35 x 20 x 26 mm; Magnet & Kunststoff magnet & plastic PBT	

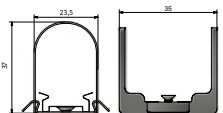

Sonstiges Montagezubehör

other mounting accessories

item	item number	product	detail	drawing
	NP/S1-MP/SC/CS	NauticProfil® Sicherheitsklammer für NP S1 (CS) NauticProfil® safety clip for NP S1	31,1 x 35 x 23,5 mm; Edelstahl stainless steel	
	NP/S1-MP/SC/CR	NauticProfil® Sicherheitsklammer für NP S1 (CR) NauticProfil® safety clip for NP S1		
	NP/S1-MP/SC/LAF-2	NauticProfil® Sicherheitsklammer für NP S1 (LAF-2) NauticProfil® safety clip for NP S1		
	NP/W-PLATE/ALA	Befestigungsplatte für NP W Montageprofil mounting plate for NP W mounting profile	90 x 31 x 5 mm; Aluminium eloxiert alu anodized	
	NP/R-BRACKET	Halterung für NP R1 Montageprofil (empfohlen) bracket for NP R1 mounting profile (recommended)	2x 74,93 x 19,69 x 34,43 mm Stahl verzinkt plastic PBT	
	NP/R-SPRING	Haltefeder für NP R1 Montageprofil retaining spring for NP R1 mounting profile	Stahl verzinkt plastic PBT	





Sonstiges Montagezubehör

other mounting accessories

item	item number	product	detail
	NP/PENDANT2	Stahlseilabhängung und Anschlussleitung (ohne Baldachin) Steel pendant set and connection cable (without canopy)	31,1 x 35 x 23,5 mm; Edelstahl stainless steel
	NP/PENDANT3	Stahlseilabhängung und Anschlussleitung mit Deckenbefestigung (Baldachin), Kabellänge ohne Werkzeug variabel einstellbar steel pendant and connection line with ceiling attachment (canopy), cable length can variably be adjusted without tools	90 x 31 x 5 mm; Aluminium eloxiert alu anodized
	NP/I2-M-plate	NP-Haltebügel für Montageprofil NP I2 auf Platte montiert NP retaining bracket for mounting profile NP I2 mounted on Plate	

Zubehör NauticProfil® System

accessoires NauticProfil® system

item	item number	product	detail
	FLNP/FCABLE-UV	NP Flachkabel NP flat cable	UV-beständig, 4 x 2,5/3,45 mm ² UV-resistant
	NP/P-GEL/75ML	NP Protection-Gel NP protection gel	zum Schutz der NP Piercing-Kontakte to protect the NP piercing contacts
	NP/P-PLATE	NP Schutzplatte NP protection plate	
	NP/SHRINK-TUBE	NP Schrumpfschlauch NP shrinkable tubing (10 per SKU / VPE)	30 mm Schrumpfschlauch, selbstklebend und verschweißend, zum Schutz des offenen Flachkabelendes 30mm shrink-tube, adhesive and heat-sealing, to protect NP cable tail
	NP/DTOOL/1	NP Demontagewerkzeug NP demounting tool	



© Schlosskeller, Stiftung Humboldt Forum, Staatliche Museen zu Berlin – Preußischer Kulturbesitz / Florian Selig

Zubehör NauticProfil® System accessoires NauticProfil® system

item	item number	product	detail
	FL/CONNECTOR/2	Wago 2-Leiter-Klemme, Box Wago 2 pole terminal block, box (50 per SKU / VPE)	0,08mm ² – 2,5mm ² , CAGE CLAMP® Anschluss 0.08mm ² – 2.5mm ² , CAGE CLAMP® connection
	FL/CONNECTOR/3	Wago 3-Leiter-Klemme, Box Wago 3 pole terminal block, box (50 per SKU / VPE)	0,08mm ² – 2,5mm ² , CAGE CLAMP® Anschluss 0.08mm ² – 2.5mm ² , CAGE CLAMP® connection
	FL/CONNECTOR/5	Wago 5-Leiter-Klemme, Box Wago 5 pole terminal block, box (40 per SKU / VPE)	0,08mm ² – 2,5mm ² , CAGE CLAMP® Anschluss 0.08mm ² – 2.5mm ² , CAGE CLAMP® connection
	NP/F-CONNECTOR	Kupplung MCS Midi female connector MCS midi	
	NP/M-CONNECTOR	Stecker MCS Midi male connector MCS midi	
	NP/IP68-FCONNECTOR	Steckerverbindung Kupplung female connector	inkl. Dichtung für Kabel mit einem Durchmesser von 5 bis 7 mm including seal for cable with diameter 5 to 7 mm
	NP/IP68-MCONNECTOR	Steckerverbindung Stecker male connector	inkl. Dichtung für NP-Flachkabel 4 x 3,5 für Kabel mit 2,5 bis 4 mm ² including seal for NP flat cable 4 x 3.5 for cable with 2.5 to 4 mm ²

Sie vermissen ein bestimmtes Zubehör? Sprechen Sie uns an!
You miss a certain accessories? Please contact us!





NauticProfil® Verdrahtungsschemata

NauticProfil® wiring diagrams

Verdrahtungsschemata dimmbar

Verdrahtungs- schema	Schaltart	Betriebsart	Belegung Flachbandkabel	Piercingkontakte (PIN) des Leuchteneinsatzes	Spannung FLASHAAR® Serienprodukte
D/PWM/1 a) 1 x 1CH b) 1 x 1CH	Leistungs-PWM (Masse geschaltet)	1-Kanal, PWM-Dimmung		a) b) + + - PWM - - PWM - nc + + nc	24/48 V DC
D/PWM/1b & D/SPWM/1c 1 x 1 CH PWM + 1 x 1 CH SPWM	1 x Leistungs-PWM (Masse geschaltet) kombi- niert mit 1 x Steuerungs- PWM (+SPWM short to: -SPWM/ -24/48 V / GND=ON; +SPWM open or short to +24/48V=OFF)	2-Kanal Dimmung: 1-Kanal PWM- Dimmung kombi- niert mit 1-Kanal SPWM-Dimmung		PWM Line SPWM PicoSpot / Focus 1-CH + + - - nc + SPWM + SPWM - - nc	24/48 V DC
D/PWM/2 aa) 1 x 2CH ab) 1 x 2CH ba) 2 x 1CH bb) 2 x 1CH	Leistungs-PWM (Masse geschaltet)	2-Kanal, PWM-Dimmung		aa) ab) ba) bb) + + + nc + nc -1 PWM - - nc - nc -2 PWM - - nc - nc + + nc + nc +	24/48 V DC
D/PWM/ Pegasus-a 1 x 2CH	Leistungs-PWM (Masse geschaltet)	2-Kanal, PWM-Dimmung		+ + -1 PWM (WW) - -2 PWM (DL) -	24 V DC
D/PWM/3 aa) 1 x 3CH ab) 1 x 3CH bb) 1 x 2CH + 1 x 1CH cb) 3 x 1CH pb) 1 x 1CH + 1 x 2CH (Pegasus)	Leistungs-PWM (Masse geschaltet)	3-Kanal, PWM-Dimmung		aa) ab) bb) cb) pb) + + + + + + + + -1 PWM - - nc - nc nc - nc -2 PWM - - nc nc - nc nc - -3 PWM - - nc nc nc - nc -	24/48 V DC
D/SPWM/1 a) 1 x 1CH b) 1 x 1CH	Steuerungs-PWM (+SPWM short to: -SPWM / -24 / -48 V / GND=ON; +SPWM open or short to +24 / +48V=OFF)	1-Kanal, SPWM-Dimmung		a) b) + + + SPWM + SPWM - SPWM - SPWM* nc - -	(24/) 48 V DC
D/SPWM/2 2 x 1CH	Steuerungs-PWM (+SPWM short to: -SPWM / -24 / -48 V / GND=ON; +SPWM open or short to +24 / +48V=OFF)	2-Kanal, SPWM-Dimmung		a) b) + + +1 SPWM + SPWM nc +2 SPWM nc + SPWM - -	(24/) 48 V DC

* -SPWM ist im Leuchteneinsatz verbunden mit - / ground
nc=nicht kontaktiert

Verdrahtungsschemata dimmbar

Verdrahtungs-schema	Besonderheit	Anwendung	FLASHAAR® Produkte
D/PWM/1 a) 1 x 1CH b) 1 x 1CH	Verpolungssicher: Leuchteneinsätze können gedreht werden, Zuleitung kann 2- oder 4-adrig ausgeführt werden (auf Stromstärke und Querschnitt achten), die + und - des Flachbandkabels werden jeweils am Eingang gebrückt	alle 1-kanaligen Leuchteneinsätze, die 2 Anschlüsse haben und Leistungs-PWM-tauglich sind	NP Line Mayflower-3, Sta. Maria-6, Victory-7, Navigator-3, Jago-2**, Nova-6**
D/PWM/1b & D/SPWM/1c 1 x 1 CH PWM + 1 x 1 CH SPWM	ACHTUNG: Wegen einer gemeinsamen Spannungsversorgung ist ein Mischbetrieb von 24 V DC und 48V DC nicht möglich, die Auswahl der zu mischenden Leuchteneinsätze richtet sich nach der gemeinsamen Spannung.	Zum gemischten Betrieb von Leistungs-PWM-Leuchteneinsätzen und Steuerungs-PWM-Leuchteneinsätzen.	NP Line Mayflower-3, Sta. Maria-6, Victory-7, Navigator-3, Jago-2**, Nova-6**, NP PicoSpot, NP Focus-4 1CH
D/PWM/2 aa) 1 x 2CH ab) 1 x 2CH ba) 2 x 1CH bb) 2 x 1CH	je nach verwendetem/n PWM-Dimmer/n kann + gebrückt sein (der nicht geschaltete Pol), Zuleitung kann gegebenenfalls 3-adrig ausgeführt werden (auf Stromstärke und Querschnitt achten), Ausrichtung der Inserts bestimmen die Zuordnung zu Kanal	PIN Typ a (aa & ab): 2-kanalige Leuchten-einsätze mit 3 Anschlüssen (gemeinsamer +), z. B. Kelvinshifting PIN Typ b (ba & bb): alle 1-kanaligen Leuchten-einsätze, die Leistungs-PWM-tauglich sind Dimmer Typ a (aa & ba): Installation mit 1 x 2-Kanal-Dimmer Dimmer Typ b (ab & bb): Installation mit 2 x 1-Kanal-Dimmer	PIN Typ a: NP Line Pegasus-4 Gold (future) PIN Typ b, 1-kanalige Leuchteneinsätze: NP Line Mayflower-3, Sta. Maria-6, Victory-7, Navigator-3, Jago-2**, Nova-6**
D/PWM/Pegasus-a 1 x 2CH	je nach verwendetem/n PWM-Dimmer/n kann + gebrückt sein (der nicht geschaltete Pol), Zuleitung kann gegebenenfalls 3-adrig ausgeführt werden (auf Stromstärke und Querschnitt achten), Inserts können nicht gedreht werden	alle Leuchteneinsätze Pegasus-4	NP Line Pegasus-4
D/PWM/3 aa) 1 x 3CH ab) 1 x 3CH bb) 1 x 2CH + 1 x 1CH cb) 3 x 1CH pb) 1 x 1CH + 1 x 2CH (Pegasus)	+ gebrückt (der nicht geschaltete Pol), auf Stromstärke und Querschnitt der dreifach belasteten + Ader achten, bei Montage unbedingt auf Ausrichtung der Leuchteneinsätze achten.	PIN Typ a (aa & ab): meist RGB-Leuchteneinsätze (3CH), mit 4 Anschlüssen (gemeinsamer +) PIN Typ b, c & p (bb, cb & pb): 1- und 2-kanalige Leuchteneinsätze, die Leistungs-PWM-tauglich sind Dimmer Typ a (aa): Installation mit 1 x 3-Kanal-Dimmer Dimmer Typ b (ab, bb, cb & pb): Installation mit 3 x 1-Kanal-Dimmer	PIN Typ a: NP Line Defiant PIN Typ b & c, 1-kanalige Leuchteneinsätze: NP Line Mayflower-3, Sta. Maria-6, Victory-7, Navigator-3, Jago-2**, Nova-6** PIN Typ p: NP Line Pegasus-4, zusätzlich siehe c
D/SPWM/1 a) 1 x 1CH b) 1 x 1CH	Leuchteinsätze können nicht gedreht werden, Versorgungsspannung sollte bei längerer Auszeit ebenfalls ausgeschaltet werden	alle 1-kanaligen Leuchteinsätze, die mit einem PWM-Steuerungssignal für PWM-Erzeugung auf Platine gedimmt werden.	NP Focus-4 1CH NP Focus-4 1CH Darklite NP PicoSpot (24 / 48 V)
D/SPWM/2 2 x 1CH	Leuchteinsätze können nicht gedreht werden, Versorgungsspannung sollte bei längerer Auszeit ebenfalls ausgeschaltet werden	zum Betrieb aller 1-kanaligen Leuchteinsätze auf 2 Kanälen, die mit einem PWM-Steuerungssignal für PWM-Erzeugung auf Platine gedimmt werden.	NP Focus-4 1CH NP Focus-4 1CH Darklite NP PicoSpot (24 / 48 V)

**Bei Leuchten der Länge > 1m werden wegen der hohen Leistung Piercing-Kontakte (PIN) in beiden Endkappen verbaut.

wiring diagrams dimmable

wiring diagram type	switching type	operating mode	pinout of the ribbon cable	piercing contacts (PIN) of the light insert	voltage FLASHAAR® serial products
D/PWM/1 a) 1 x 1CH b) 1 x 1CH	Power PWM (Ground is switched)	1-channel, PWM-dimming		a) + - - + b) + - nc nc	24/48 V DC
D/PWM/1b & D/SPWM/1c 1 x 1 CH PWM + 1 x 1 CH SPWM	1 x power PWM (ground switched) combined with 1 x control PWM (+SPWM short to: -SPWM/ -24/48 V / GND=ON; +SPWM open or short to +24/48V=OFF)	2-channel dim- ming: 1-channel PWM dimming combined with 1-channel SPWM dimming		PWM Line + - nc nc SPWM PicoSpot / Focus 1-CH + nc +SPWM -	24/48 V DC
D/PWM/2 aa) 1 x 2CH ab) 1 x 2CH ba) 2 x 1CH bb) 2 x 1CH	Power PWM (Ground is switched)	2-channel, PWM-dimming		aa) + - - + ab) + - - + ba) + - nc + bb) + - nc nc +	24/48 V DC
D/PWM/ Pegasus-a 1 x 2CH	Power PWM (Ground is switched)	2-channel, PWM-dimming		+ + - -	24 V DC
D/PWM/3 aa) 1 x 3CH ab) 1 x 3CH bb) 1 x 2CH + 1 x 1CH cb) 3 x 1CH pb) 1 x 1CH + 1 x 2CH (Pegasus)	Power PWM (Ground is switched)	3-channel, PWM-dimming		aa) + - - - ab) + - - - bb) + - nc - cb) + - nc nc - pb) + - nc nc - nc	24/48 V DC
D/SPWM/1 a) 1 x 1CH b) 1 x 1CH	Trigger PWM (+SPWM short to: -SPWM / -24 / -48 V / GND=ON; +SPWM open or short to +24 / +48V=OFF)	1-channel, SP- WM-dimming		a) + + SPWM - SPWM* - b) + + SPWM nc -	(24/) 48 V DC
D/SPWM/2 2 x 1CH	Trigger PWM (+SPWM short to: -SPWM / -24 / -48 V / GND=ON; +SPWM open or short to +24 / +48V=OFF)	2-channel, SP- WM-dimming		a) + + SPWM nc - b) + nc + SPWM -	(24/) 48 V DC

* -SPWM is internally connected to - / ground
nc=not connected

wiring diagrams dimmable

wiring diagram type	Specific characteristic	Application	FLASHAAR® products
D/PWM/1 a) 1 x 1CH b) 1 x 1CH	Secured against reverse polarity: light inserts can be turned, cabling can be carried out with 2 or 4 wires (ensure current and cross section), the + and – of the ribbon cable are bridged at the input.	PIN type a: all 1-channel light inserts, which have only 2 ports and are power-PWM-capable PIN Typ b: Mixed operation of D/SPWM/1c or D/SPWM/O	NP Line Mayflower-3, Sta. Maria-6, Victory-7, Navigator-3, Jago-2**, Nova-6**
D/PWM/1b & D/SPWM/1c 1 x 1 CH PWM + 1 x 1 CH SPWM	ATTENTION: Due to a common voltage supply, mixed operation of 24 V DC and 48V DC is not possible, the selection of the luminaire inserts to be mixed depends on the common voltage.	For mixed operation of power PWM- and control PWM luminaire inserts.	NP Line Mayflower-3, Sta. Maria-6, Victory-7, Navigator-3, Jago-2**, Nova-6**, NP PicoSpot, NP Focus-4 1CH
D/PWM/2 aa) 1 x 2CH ab) 1 x 2CH ba) 2 x 1CH bb) 2 x 1CH	Depending on the applied PWM dimmer, + can be bridged (the unswitched pole). Feed-in can optionally be run 3 wires (ensure current and cross section). Alignment of the light inserts determine the assignment to channel.	PIN type a (aa & ab): 2-channel light inserts with 3 connections (common +), for example Kelvin shifting PIN type b (ba & bb): all LED boards, which are power-PWM-capable Dimmer type a (aa & ba): Installation with 1 x 2-channel dimmer Dimmer type b (ab & bb): Installation with 2 x 1-channel dimmer	PIN type a: NP Line Pegasus-4 Gold (future) PIN type b, 1-channel light inserts: NP Line Mayflower-3, Sta. Maria-6, Victory-7, Navigator-3, Jago-2**, Nova-6**
D/PWM/Pegasus-a 1 x 2CH	Depending on the applied PWM dimmer, + can be bridged (the unswitched pole). Feed-in can optionally be run 3 wires (ensure current and cross section). Light inserts cannot be turned.	all light inserts Pegasus-4	NP Line Pegasus-4
D/PWM/3 aa) 1 x 3CH ab) 1 x 3CH bb) 1 x 2CH + 1 x 1CH cb) 3 x 1CH pb) 1 x 1CH + 1 x 2CH (Pegasus)	+ is bridged (the unswitched pole), pay attention to current and cross section of the triple-loaded + wire. While mounting, pay attention to the correct alignment of the light inserts.	PIN type a (aa & ab): usually RGB light inserts (3C), with 4 ports (common +) PIN type b, c & p (bb, cb & pb): 1- and 2-channel light inserts, which are power-PWM-capable Dimmer type a (aa): Installation with 1 x 3-channel dimmer Dimmer type b (ab, bb, cb & pb): Installation with 3 x 1-channel dimmer	PIN type a: NP Line Defiant PIN type c Mixed operation of three 1-channel light inserts: NP Line Mayflower-3, Sta. Maria-6, Victory-7, Navigator-3, Jago-2**, Nova-6** PIN type p: NP Line Pegasus-4, additionally look c
D/SPWM/1 a) 1 x 1CH b) 1 x 1CH	Light inserts can not be turned. Supply voltage should also be turned off during longer off-time.	PIN type a: all 1-channel light inserts which are dimmed with a PWM control signal for PWM generation on the board PIN Type b: Mixed operation with D/PWM/1b	PIN type a, b: NP Focus-4 1CH NP Focus-4 1CH Darklite NP PicoSpot (24 / 48 V)
D/SPWM/2 2 x 1CH	Light inserts can not be turned. Supply voltage should also be turned off during longer off-time.	to operate all 1-channel light inserts on 2 channels, which are dimmed with a PWM control signal for PWM generation on the board	NP Focus-4 1CH NP Focus-4 1CH Darklite NP PicoSpot (24 / 48 V)

**For luminaires of length > 1m, piercing contacts (PIN) are installed in both end caps due to the high power.

Verdrahtungsschemata dimmbar wiring diagrams dimmable

WD/D/PWM/1

WD/D/PWM/1a* (1x1CH)

Dimmbar mittels PWM, System mit 1 Kanal, 24/48VDC /
1CH Leuchteneinsätze mit redundanter PIN-Belegung / Dimmart: PWM
dimmable by PWM, system with 1 channel, 24/48VDC /
1CH light insert with double PIN connection / dimming: PWM

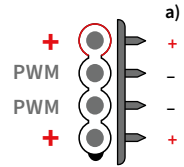

WD/D/PWM/1b* (1x1CH)

Dimmbar mittels PWM, System mit 1 Kanal, 24/48VDC /
1CH Leuchteneinsätze ohne redundanter PIN-Belegung / Dimmart: PWM
dimmable by PWM, system with 1 channel, 24/48VDC /
1CH light insert without double PIN connection / dimming: PWM

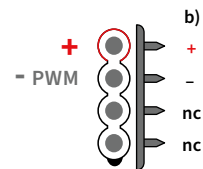
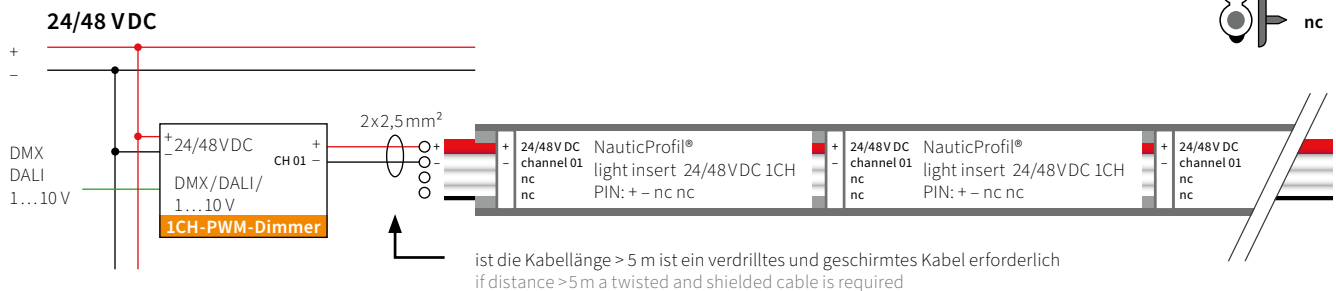

D/PWM/1b & D/SPWM/1c (1x1CH PWM + 1x1CH SPWM)

Dimmbar, System bestehend aus 1CH NP Leuchteneinsatz
PWM und 1CH NP Leuchteneinsatz SPWM (Kombination aus
Leistungs-PWM und Steuerungs-PWM)

dimmable, system consisting of 1CH NP light insert PWM and
1CH NP light insert SPWM (combination of performance PWM
and control PWM)

+SPWM short to: -SPWM / -24 / -48V / GND=ON;
+SPWM open or short to +24 / +48V=OFF

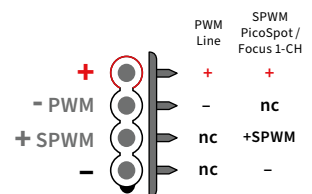
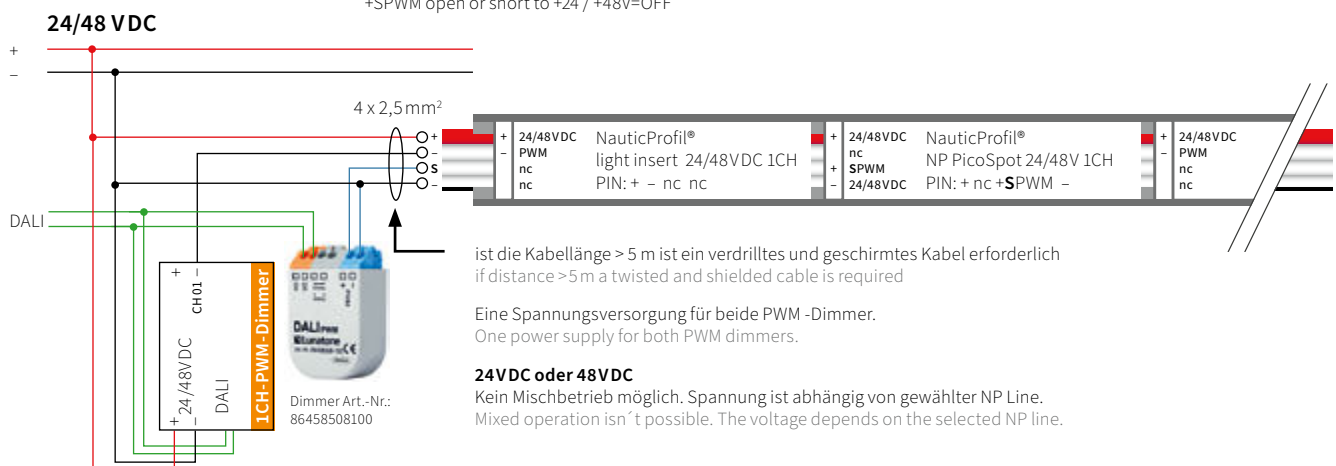

*Bei NP Line Nova und /oder Jago mit der Länge > 1m, werden wegen der hohen Leistung Piercing-Kontakte (PIN) in beiden Endkappen verbaut.
For NP Line Nova an /or Jago with a length > 1m, piercing contacts (PIN) are installed in both end caps due to the high power.

Verdrahtungsschemata dimmbar wiring diagrams dimmable

WD/D/PWM/2

WD/D/PWM/2aa (1x2CH)

Dimmbar mittels PWM, System mit 2 Kanälen, 24/48VDC /
2CH Leuchteneinsätze / Dimmart: PWM
dimmable by PWM, system with 2 channels, 24/48VDC /
2CH light insert / dimming: PWM

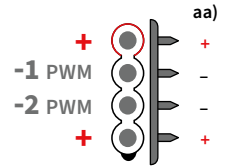

WD/D/PWM/2ab (1x2CH)

Dimmbar mittels PWM, System mit 2 Kanälen, 24/48VDC /
2CH Leuchteneinsätze / Dimmart: PWM
dimmable by PWM, system with 2 channels, 24/48VDC /
2CH light insert / dimming: PWM

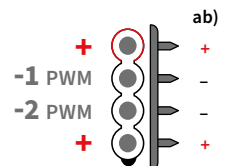
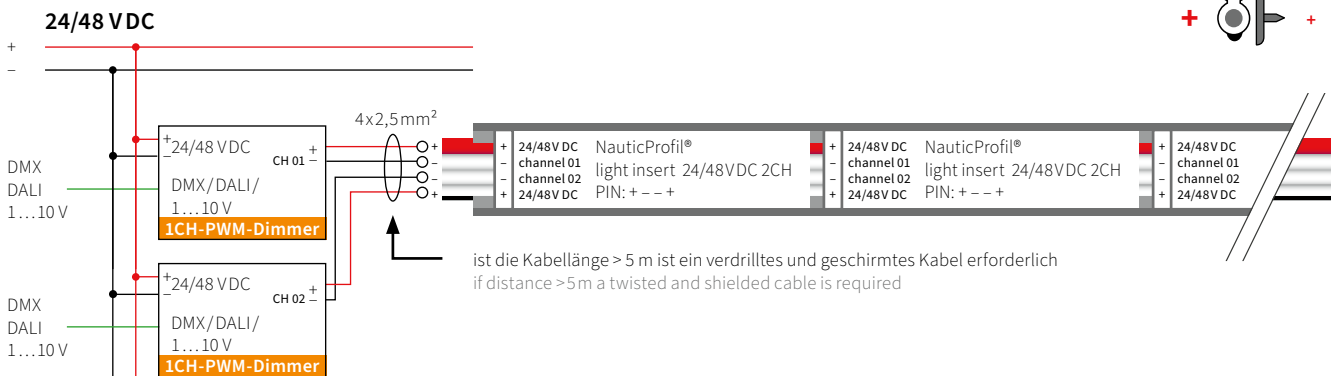

WD/D/PWM/2ba (2x1CH)

Dimmbar mittels PWM, System mit 1 Dimmer 2CH, 24/48VDC /
1CH Leuchteneinsätze / Dimmart: PWM
dimmable by PWM, system with 1 dimmer 2CH, 24/48VDC /
1CH light insert / dimming: PWM

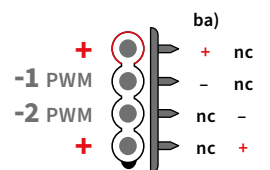
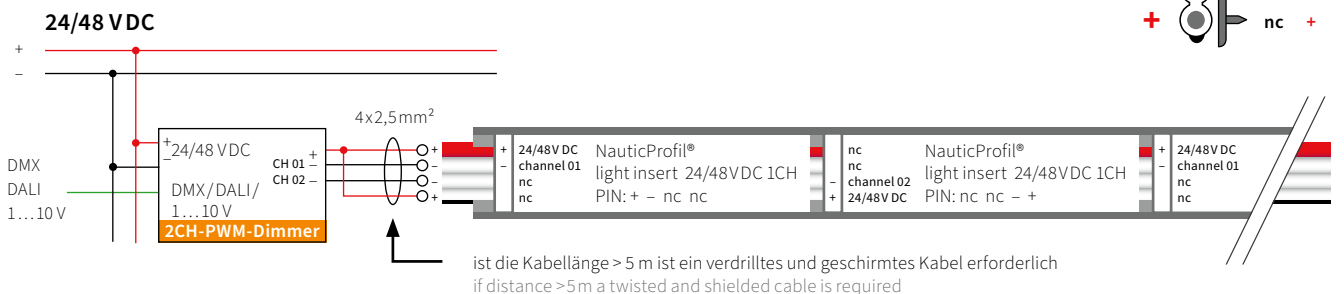

Verdrahtungsschemata dimmbar

wiring diagrams dimmable

WD/D/PWM/2

WD/D/PWM/2bb (2x1CH)

Dimmbar mittels PWM, System mit 2 Dimmern 1CH, 24/48VDC /
1CH Leuchteneinsätze / Dimmart: PWM
dimmable by PWM, system with 2 dimmer 1CH, 24V/48 DC /
1CH light insert / dimming: PWM

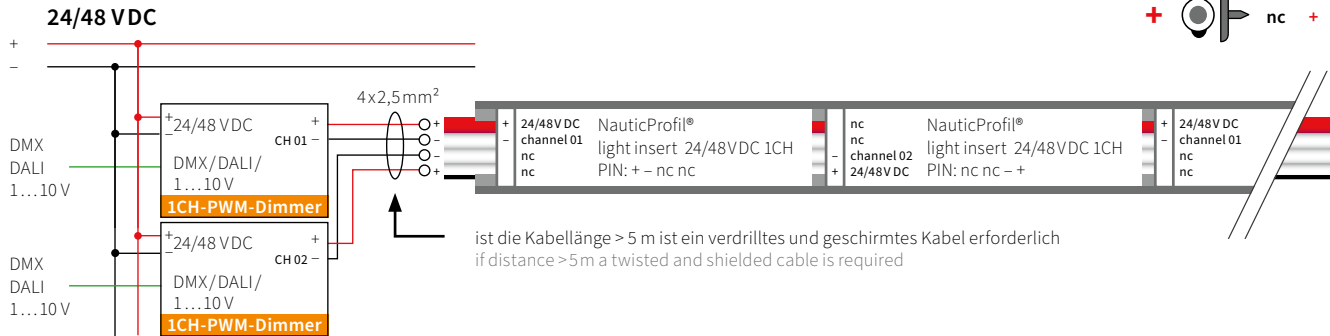
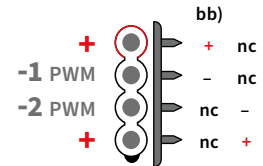

WD/D/PWM/3

WD/D/PWM/3aa (1x3CH)

Dimmbar mittels PWM, System mit 3 Kanälen, 24/48VDC /
3CH Leuchteneinsätze (z. B. RGB)
dimmable by PWM, system with 3 channels, 24/48VDC /
3CH light inserts (e.g. RGB)

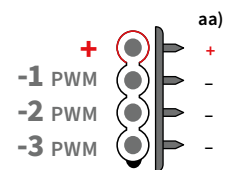

⚠ Achtung! Strombelastbarkeit bei gemeinsamen + Pol im Flachbandkabel ≤ 20 A.
Attention! Maximum current capacity with common + pole in the flat cable ≤ 20 A.

WD/D/PWM/3ab (1x3CH)

Dimmbar mittels PWM, System mit 3 Kanälen, 24/48VDC /
3CH Leuchteneinsätze (z. B. RGB)
dimmable by PWM, system with 3 channels, 24/48VDC /
3CH light inserts (e.g. RGB)

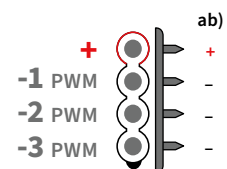

⚠ Achtung! Strombelastbarkeit bei gemeinsamen + Pol im Flachbandkabel ≤ 20 A.
Attention! Maximum current capacity with common + pole in the flat cable ≤ 20 A.

Verdrahtungsschemata dimmbar wiring diagrams dimmable

WD/D/PWM/3

WD/D/PWM/3bb* (1x2CH + 1x1CH)

Dimmbar mittels PWM, System mit 2+1 Kanälen, 24/48 V DC /
Paralleler Betrieb von 2CH und 1CH Leuchteneinsätzen
dimnable by PWM, system with 2+1 channels, 24/48 V DC /
parallel operation of 2CH and 1CH light inserts

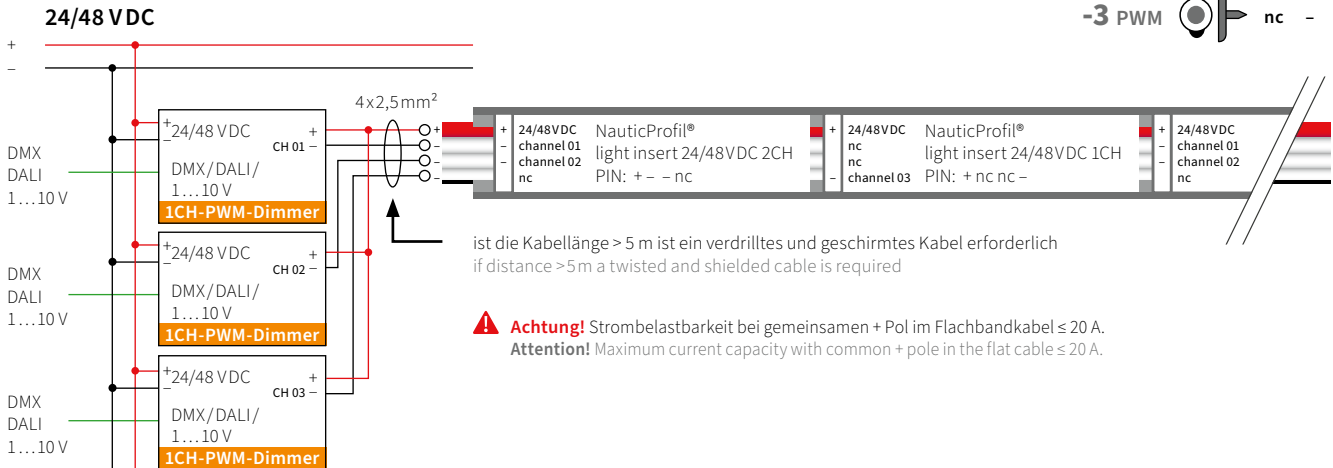
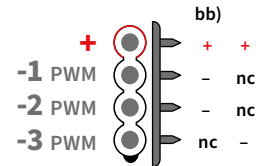

WD/D/PWM/3cb* (3x1CH)

Dimmbar mittels PWM, System mit 3 unterschiedlichen Kanälen, 24/48V DC
dimnable by PWM, system with 3 different channels, 24/48V DC

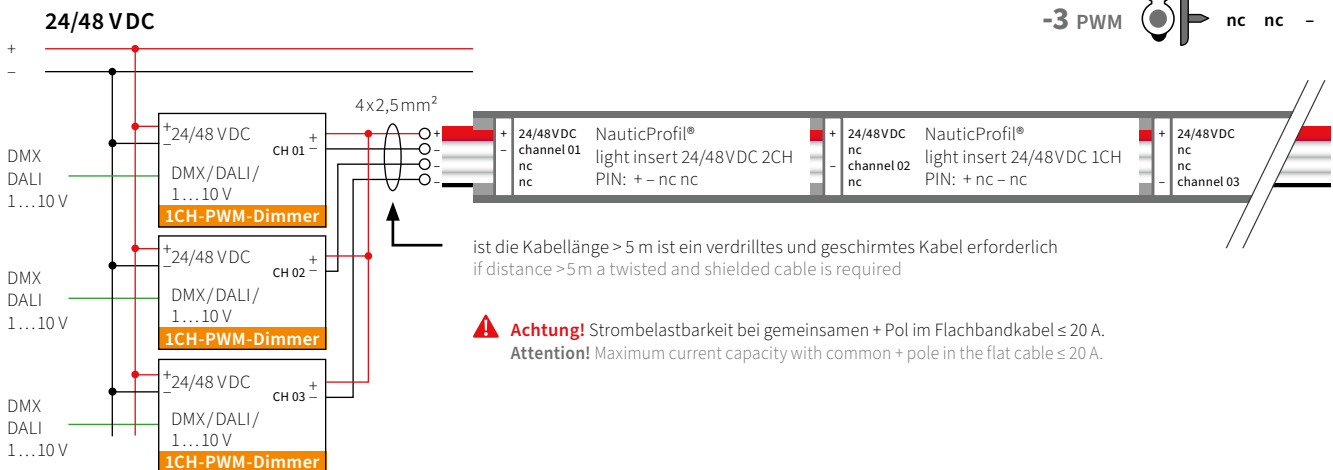
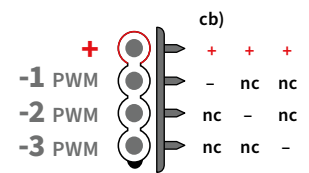

*Bei NP Line Nova und /oder Jago mit der Länge > 1m, werden wegen der hohen Leistung Piercing-Kontakte (PIN) in beiden Endkappen verbaut.
For NP Line Nova an /or Jago with a length > 1m, piercing contacts (PIN) are installed in both end caps due to the high power.

Verdrahtungsschemata dimmbar

wiring diagrams dimmable

WD/D/PWM/3

WD/D/PWM/3pb*
(1x1CH + 1x2CH)

Dimmbar mittels PWM, System mit 1+2 Kanälen, 24 V DC /
Paralleler Betrieb von 1CH Leuchteinsätzen und 2CH NP Pegasus
dimmable by PWM, system with 1+2 channels, 24V DC /
parallel operation of 1CH light inserts and 2CH NP Pegasus

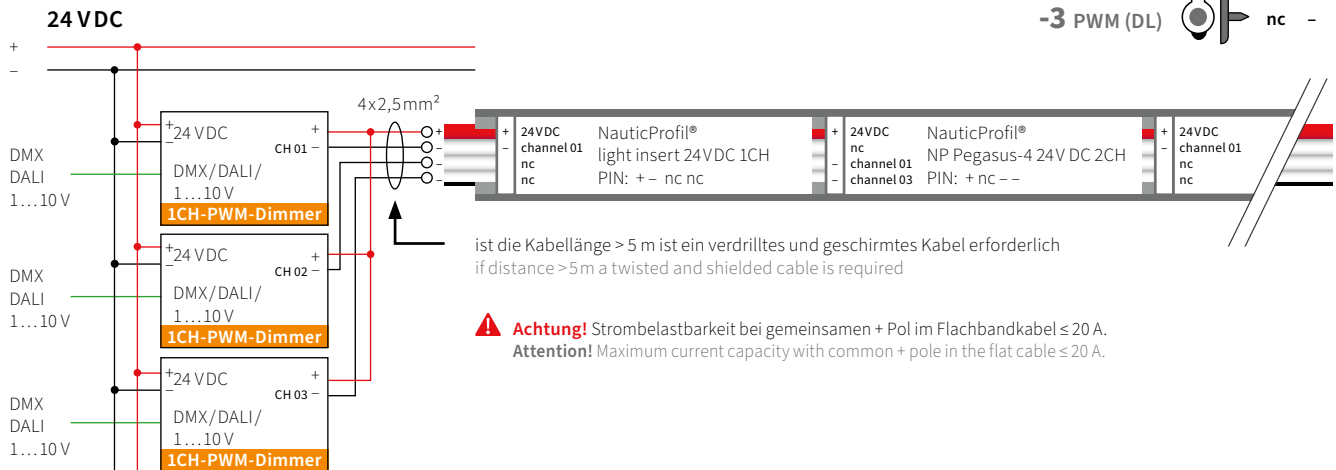

WD/D/PWM/Pegasus-a
(1x2CH)

Dimmbar mittels PWM, System mit 2 Kanälen für NP Pegasus, 24VDC
dimmable by PWM, system with 2 channels for NP Pegasus, 24 VDC

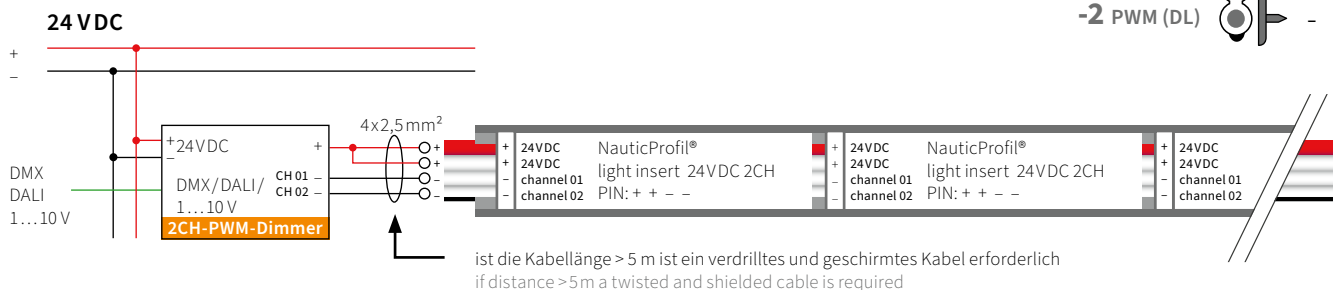

*Bei NP Line Nova und /oder Jago mit der Länge > 1m, werden wegen der hohen Leistung Piercing-Kontakte (PIN) in beiden Endkappen verbaut.
For NP Line Nova an /or Jago with a length > 1m, piercing contacts (PIN) are installed in both end caps due to the high power.

Verdrahtungsschemata dimmbar wiring diagrams dimmable

WD/D/SPWM/1

WD/D/SPWM/1a
(1x1CH)

Dimmbar über SPWM, System mit 1 Kanal, 24/48VDC /
1CH Leuchteneinsatz / Dimmart: Steuerungs-PWM (SPWM)
dimmable via SPWM, 24/48VDC single channel system /
1CH light insert (monochrome) / dimming: Signal-PWM

+SPWM short to: -SPWM / -24/48V / GND=ON; +SPWM open or short to +24/48V=OFF

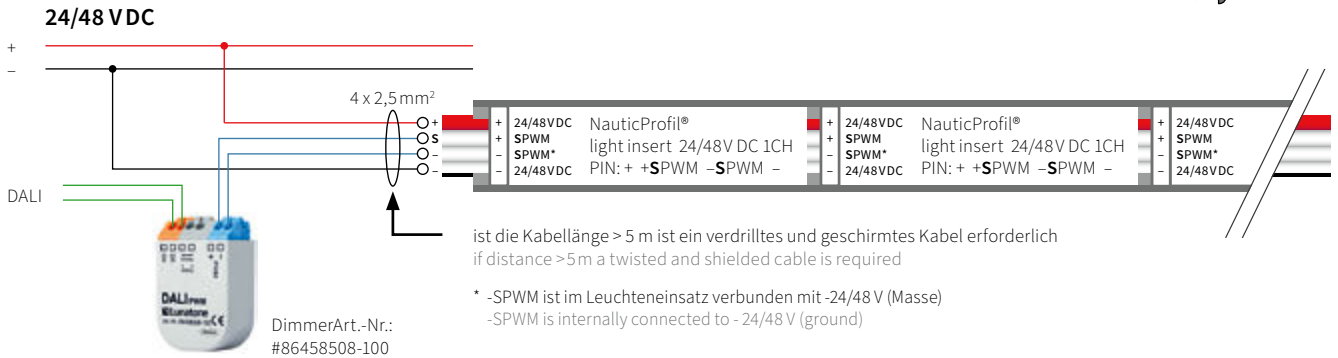
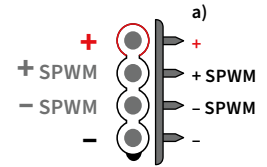

WD/D/SPWM/1b
(1x1CH)

Dimmbar über SPWM, System mit 1 Kanal, 24/48VDC /
1CH Leuchteneinsatz / Dimmart: Steuerungs-PWM (SPWM)
dimmable via SPWM, 24/48VDC single channel system /
1CH light insert (monochrome) / dimming: Signal-PWM

+SPWM short to: -SPWM / -24/48V / GND=ON; +SPWM open or short to +24/48V=OFF

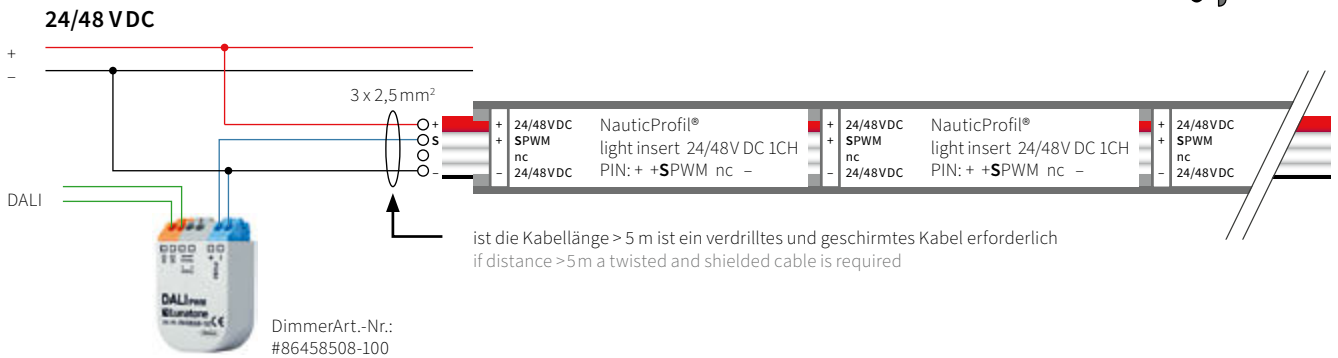
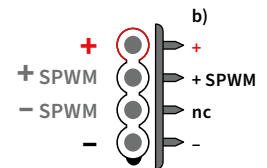

WD/D/SPWM/2
(2x1CH)

zum Dimmen aller 1CH Leuchteinsätze auf 2 Kanälen, die mit einem
PWM-Steuerungssignal für PWM-Erzeugung auf Platine gedimmt werden
for dimming all 1CH light inserts on 2 channels, which are dimmed with a
PWM control signal for PWM generation on the board

+SPWM short to: -SPWM / -24/48V / GND=ON; +SPWM open or short to +24/48V=OFF

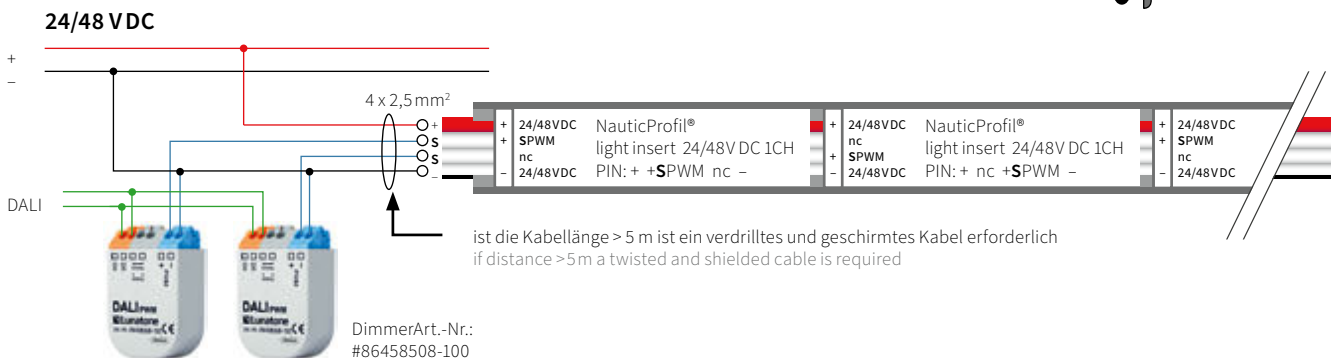
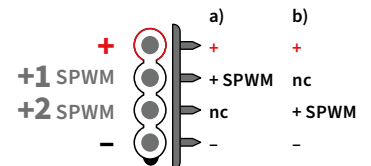

Verdrahtungsschemata schaltbar

Verdrahtungs- schema	Schaltart	Betriebsart	Belegung Flachbandkabel	Piercingkontakte (PIN) des Leuchteneinsatzes	Spannung FLASHAAR® Serienprodukte																								
S/1 a) 1 x 1CH b) 1 x 1CH	An-Aus, Sekundär Masse geschaltet	1-Kanal, schaltbar		<table border="0"> <tr> <td>a)</td> <td>b)</td> </tr> <tr> <td>+</td> <td>+</td> </tr> <tr> <td>-</td> <td>-</td> </tr> <tr> <td>-</td> <td>nc</td> </tr> <tr> <td>+</td> <td>nc</td> </tr> </table>	a)	b)	+	+	-	-	-	nc	+	nc	24/48 V DC														
a)	b)																												
+	+																												
-	-																												
-	nc																												
+	nc																												
S/1b & S/PWM/1c 1 x 1CH + 1 x 1CH SPWM	1. Kanal An-Aus, Sekundär Masse geschaltet & 2. Kanal An-Aus per Steuerungs-PWM (+SPWM short to: -24V / -48 V / GND=ON +SPWM open or short to +24V / +48V=OFF)	2-Kanal: 1-Kanal schaltbar kombiniert mit 1-Kanal über SPWM geschaltet		<table border="0"> <tr> <td>PWM Line</td> <td>SPWM PicoSpot / Focus 1-CH</td> </tr> <tr> <td>+</td> <td>+</td> </tr> <tr> <td>-</td> <td>nc</td> </tr> <tr> <td>nc</td> <td>+SPWM</td> </tr> <tr> <td>nc</td> <td>-</td> </tr> </table>	PWM Line	SPWM PicoSpot / Focus 1-CH	+	+	-	nc	nc	+SPWM	nc	-	24/48 V DC														
PWM Line	SPWM PicoSpot / Focus 1-CH																												
+	+																												
-	nc																												
nc	+SPWM																												
nc	-																												
S/2 a) 1 x 2CH b) 2 x 1CH	An-Aus, Sekundär Masse geschaltet	2-Kanal, schaltbar		<table border="0"> <tr> <td>a)</td> <td>b)</td> </tr> <tr> <td>+</td> <td>+</td> </tr> <tr> <td>-</td> <td>-</td> </tr> <tr> <td>-</td> <td>nc</td> </tr> <tr> <td>+</td> <td>nc</td> </tr> </table>	a)	b)	+	+	-	-	-	nc	+	nc	24/48 V DC														
a)	b)																												
+	+																												
-	-																												
-	nc																												
+	nc																												
S/3 a) 1 x 3CH b) 1 x 2CH + 1 x 1CH c) 3 x 1CH p) 1 x 1CH (Pegasus-4) + 1 x 2CH	An-Aus, Sekundär Masse geschaltet	3-Kanal, schaltbar		<table border="0"> <tr> <td>a)</td> <td>b)</td> <td>c)</td> <td>p)</td> </tr> <tr> <td>+</td> <td>+</td> <td>+</td> <td>+</td> </tr> <tr> <td>-</td> <td>-</td> <td>nc</td> <td>-</td> </tr> <tr> <td>-</td> <td>-</td> <td>nc</td> <td>nc</td> </tr> <tr> <td>-</td> <td>nc</td> <td>nc</td> <td>-</td> </tr> <tr> <td>-</td> <td>nc</td> <td>nc</td> <td>nc</td> </tr> </table>	a)	b)	c)	p)	+	+	+	+	-	-	nc	-	-	-	nc	nc	-	nc	nc	-	-	nc	nc	nc	24/48 V DC S/3p: 24V
a)	b)	c)	p)																										
+	+	+	+																										
-	-	nc	-																										
-	-	nc	nc																										
-	nc	nc	-																										
-	nc	nc	nc																										
S/Pegasus 1 x 2CH	An-Aus, Sekundär Masse geschaltet	2-Kanal, schaltbar		<table border="0"> <tr> <td>+</td> <td>+</td> </tr> <tr> <td>-</td> <td>-</td> </tr> </table>	+	+	-	-	24 V DC																				
+	+																												
-	-																												
S/SPWM/1 a) 1 x 1CH b) 1 x 1CH	An-Aus per Steuerungs-PWM (+SPWM short to: -SPWM / -24V / -48 V / GND=ON; +SPWM open or short to +24V / +48V=OFF)	1-Kanal, über SPWM geschaltet		<table border="0"> <tr> <td>a)</td> <td>b)</td> </tr> <tr> <td>+</td> <td>+</td> </tr> <tr> <td>+</td> <td>+ SPWM</td> </tr> <tr> <td>-</td> <td>- SPWM</td> </tr> <tr> <td>-</td> <td>nc</td> </tr> <tr> <td>-</td> <td>-</td> </tr> </table>	a)	b)	+	+	+	+ SPWM	-	- SPWM	-	nc	-	-	24/48 V DC												
a)	b)																												
+	+																												
+	+ SPWM																												
-	- SPWM																												
-	nc																												
-	-																												
S/SPWM/2 2 x 1CH	An-Aus per Steuerungs-PWM (+SPWM short to: -SPWM / -24V / -48 V / GND=ON; +SPWM open or short to +24V / +48V=OFF)	2-Kanal, über SPWM geschaltet		<table border="0"> <tr> <td>a)</td> <td>b)</td> </tr> <tr> <td>+</td> <td>+</td> </tr> <tr> <td>+</td> <td>nc</td> </tr> <tr> <td>nc</td> <td>+ SPWM</td> </tr> <tr> <td>-</td> <td>-</td> </tr> </table>	a)	b)	+	+	+	nc	nc	+ SPWM	-	-	24/48 V DC														
a)	b)																												
+	+																												
+	nc																												
nc	+ SPWM																												
-	-																												
E	An-Aus, Primärseite: 230 V des Konverters	Energiesparend	kombinierbar mit allen anderen Installationsschemata		24/48 V DC																								

* -SPWM ist im Leuchteneinsatz verbunden mit - / ground
nc=nicht kontaktiert

Verdrahtungsschemata schaltbar

Verdrahtungs-schemata	Besonderheit	Anwendung	FLASHAAR® Produkte
S/1 a) 1 x 1CH b) 1 x 1CH	PIN Typ a: Verpolungssicher: Leuchteneinsätze können gedreht werden, Zuleitung kann 2-adrig ausgeführt werden (auf Stromstärke und Querschnitt achten), die + und - des Flachbandkabels werden jeweils am Eingang gebrückt	PIN Typ a: alle 1-kanaligen Leuchteneinsätze PIN Typ b: alle 1-kanaligen Leuchteneinsätze für besondere Anwendung, z.B. Mischbetriebe	NP Line Mayflower-3, Sta. Maria-6, Victory-7, Navigator-3, Jago-2**, Nova-6**
S/1b & S/PWM/1c 1 x 1CH + 1 x 1CH SPWM	Zum gemischten Betrieb von 1-kanaligen Leuchteneinsätzen ohne separaten Steuereingang und Steuerungs-PWM-Leuchteneinsätzen. ACHTUNG: Wegen einer gemeinsamen Spannungsversorgung ist ein Mischbetrieb von 24 V DC und 48 V DC nicht möglich, die Auswahl der zu mischenden Leuchteneinsätze richtet sich nach der gemeinsamen Spannung.		NP Line Mayflower-3, Sta. Maria-6, Victory-7, Navigator-3, Jago-2**, Nova-6**, NP PicoSpot, NP Focus-4 1CH
S/2 a) 1 x 2CH b) 2 x 1CH	Drehen der Leuchteneinsätze ändert die Zuordnung zu Kanal, der nicht geschaltete + Pol kann gebrückt sein, die Zuleitung kann gegebenenfalls 3-adrig ausgeführt werden (auf Stromstärke und Querschnitt achten).	alle Anwendungen mit 2 Kanälen (Farben) und Leuchteneinsätze ohne separaten Steuereingang. PIN Typ a: 2-kanalige Leuchteneinsätze mit 3 Polen (doppelter +). PIN Typ b: Betrieb von 2 unterschiedlichen 1-kanaligen Leuchteneinsätzen mit jeweils zweipoligem Anschluß.	PIN Typ a: NP Line Pegasus-4 Gold (future) PIN Typ b, 1-kanalige Leuchteneinsätze: NP Line Mayflower-3, Sta. Maria-6, Victory-7, Navigator-3, Jago-2**, Nova-6**
S/3 a) 1 x 3CH b) 1 x 2CH + 1 x 1CH c) 3 x 1CH p) 1 x 1 CH (Pegasus-4) + 1 x 2CH	Leuchteneinsätze dürfen nicht gedreht werden, auf Stromstärke und Querschnitt der gemeinsamen +Leitung muss geachtet werden	PIN Typ a: 3-kanalige Leuchteneinsätze mit 4 Polen. PIN Typ b: paralleler Betrieb von 2-kanaligen (3 Pole) und 1-kanaligen Leuchteneinsätzen (2 Pole). PIN Typ c: Betrieb von 3 unterschiedlichen 1-kanaligen Leuchteneinsätzen (2 Pole) PIN Typ p: paralleler Betrieb von 1-kanaligen (2 Pole) und 2-kanaligen Leuchteneinsätzen Typ Pegasus-4 (3 Pole)	PIN Typ a: NP Line Defiant PIN Typ b & c, 1-kanalige Leuchteneinsätze: NP Line Mayflower-3, Sta. Maria-6, Victory-7, Navigator-3, Jago-2**, Nova-6** PIN Typ p: NP Line Pegasus-4, zusätzlich siehe c
S/Pegasus 1 x 2CH	Leuchteneinsätze können nicht gedreht werden, Kanäle sind codiert, der nicht geschaltete +Pol kann gebrückt sein, die Zuleitung kann gegebenenfalls 3-adrig ausgeführt werden (auf Stromstärke und Querschnitt achten).	alle Leuchteneinsätze Pegasus-4	NP Line Pegasus-4
S/SPWM/1 a) 1 x 1CH b) 1 x 1CH	Leuchteneinsätze dürfen nicht gedreht werden, das Schalten per SPWM ist wegen der geringen Schaltströme besser, als das direkte Schalten der Last, +SPWM per Schalter oder Aktor an -SPWM oder - schaltet die Leuchte ein, Versorgungsspannung sollte bei längerer Aus-Zeit ebenfalls ausgeschaltet werden.	PIN Typ a: alle 1-kanaligen Leuchteinsätze, die mit einem PWM-Steuerungssignal für PWM-Erzeugung auf Platine gedimmt werden. PIN Typ b: für Betrieb mit dreiadriger Zuleitung	PIN Typ a & b: NP Focus-4 1CH, NP Focus-4 1CH Darklite, NP PicoSpot (24 / 48 V)
S/SPWM/2 2 x 1CH	Leuchteneinsätze dürfen nicht gedreht werden, das Schalten per SPWM ist wegen der geringen Schaltströme besser, als das direkte Schalten der Last, +SPWM per Schalter oder Aktor an - schaltet die Leuchte ein, Versorgungsspannung sollte bei längerer Aus-Zeit ebenfalls ausgeschaltet werden.	zum Schalten aller 1-kanaligen Leuchteinsätze auf 2 Kanälen, die mit einem PWM-Steuerungssignal für PWM-Erzeugung auf Platine gedimmt werden.	NP Focus-4 1CH, NP Focus-4 1CH Darklite, NP PicoSpot (24 / 48 V)
E	Bei einfachen Installationen kann auf das Schalten der Zuleitung von VG zu NP System verzichtet werden. Auch bei allen anderen Installationen sollte das VG primärseitig vom Netz getrennt werden, wenn das NP länger ausgeschaltet ist.	kombinierbar mit allen anderen Installations-schemata	Alle Produkte

**Bei Leuchten der Länge > 1m werden wegen der hohen Leistung Piercing-Kontakte (PIN) in beiden Endkappen verbaut.

wiring diagrams to switch on/off

wiring diagram type	switching type	operating mode	pinout of the ribbon cable	piercing contacts (PIN) of the light insert	voltage FLASHAAR® serial products																								
S/1 a) 1 x 1CH b) 1 x 1CH	on-off, primary side: 230V of the converter	energy saving		<table border="0"> <tr> <td>a)</td> <td>b)</td> </tr> <tr> <td>+</td> <td>+</td> </tr> <tr> <td>-</td> <td>-</td> </tr> <tr> <td>-</td> <td>nc</td> </tr> <tr> <td>+</td> <td>nc</td> </tr> </table>	a)	b)	+	+	-	-	-	nc	+	nc	24/48 V DC														
a)	b)																												
+	+																												
-	-																												
-	nc																												
+	nc																												
S/1b & S/PWM/1c 1 x 1CH + 1 x 1CH SPWM	1. channel on-off, secondary ground switched & 2. channel on-off, via control PWM (+SPWM short to: -24V / -48 V / gnd=on +SPWM open or short to +24V / +48V=off)	2-channel: 1-channel switchable combined with 1-channel switched via SPWM		<table border="0"> <tr> <td>PWM Line</td> <td>SPWM PicoSpot / Focus 1-CH</td> </tr> <tr> <td>+</td> <td>+</td> </tr> <tr> <td>-</td> <td>nc</td> </tr> <tr> <td>nc</td> <td>+SPWM</td> </tr> <tr> <td>nc</td> <td>-</td> </tr> </table>	PWM Line	SPWM PicoSpot / Focus 1-CH	+	+	-	nc	nc	+SPWM	nc	-	24/48 V DC														
PWM Line	SPWM PicoSpot / Focus 1-CH																												
+	+																												
-	nc																												
nc	+SPWM																												
nc	-																												
S/2 a) 1 x 2CH b) 2 x 1CH	on-off, secondary side switched to ground	2-channel, switchable		<table border="0"> <tr> <td>a)</td> <td>b)</td> </tr> <tr> <td>+</td> <td>+</td> </tr> <tr> <td>-</td> <td>-</td> </tr> <tr> <td>-</td> <td>nc</td> </tr> <tr> <td>+</td> <td>nc</td> </tr> </table>	a)	b)	+	+	-	-	-	nc	+	nc	24/48 V DC														
a)	b)																												
+	+																												
-	-																												
-	nc																												
+	nc																												
S/3 a) 1 x 3CH b) 1 x 2CH + 1 x 1CH c) 3 x 1CH p) 1 x 1CH (Pegasus-4) + 1 x 2CH	on-off, secondary side switched to ground	3-channel, switchable		<table border="0"> <tr> <td>a)</td> <td>b)</td> <td>c)</td> <td>p)</td> </tr> <tr> <td>+</td> <td>+</td> <td>+</td> <td>+</td> </tr> <tr> <td>-</td> <td>-</td> <td>nc</td> <td>-</td> </tr> <tr> <td>-</td> <td>-</td> <td>nc</td> <td>nc</td> </tr> <tr> <td>-</td> <td>nc</td> <td>nc</td> <td>-</td> </tr> <tr> <td>-</td> <td>nc</td> <td>nc</td> <td>nc</td> </tr> </table>	a)	b)	c)	p)	+	+	+	+	-	-	nc	-	-	-	nc	nc	-	nc	nc	-	-	nc	nc	nc	24/48 V DC S/3p: 24V
a)	b)	c)	p)																										
+	+	+	+																										
-	-	nc	-																										
-	-	nc	nc																										
-	nc	nc	-																										
-	nc	nc	nc																										
S/Pegasus 1 x 2CH	on-off, secondary side switched to ground	2-channel, switchable		<table border="0"> <tr> <td>+</td> </tr> <tr> <td>+</td> </tr> <tr> <td>-</td> </tr> </table>	+	+	-	24 V DC																					
+																													
+																													
-																													
S/SPWM/1 a) 1 x 1CH b) 1 x 1CH	on-off via power PWM (+SPWM short to: -SPWM / -24V / -48 V / gnd=on; +SPWM open or short to +24V / +48V=off)	1-channel, pwm-switchable		<table border="0"> <tr> <td>a)</td> <td>b)</td> </tr> <tr> <td>+</td> <td>+</td> </tr> <tr> <td>+</td> <td>+ SPWM</td> </tr> <tr> <td>-</td> <td>- SPWM</td> </tr> <tr> <td>-</td> <td>nc</td> </tr> </table>	a)	b)	+	+	+	+ SPWM	-	- SPWM	-	nc	24/48 V DC														
a)	b)																												
+	+																												
+	+ SPWM																												
-	- SPWM																												
-	nc																												
S/SPWM/2 2 x 1CH	on-off via power PWM (+SPWM short to: -SPWM / -24V / -48 V / gnd=on; +SPWM open or short to +24V / +48V=off)	2-channel, spwm-switchable		<table border="0"> <tr> <td>a)</td> <td>b)</td> </tr> <tr> <td>+</td> <td>+</td> </tr> <tr> <td>+</td> <td>nc</td> </tr> <tr> <td>nc</td> <td>+ SPWM</td> </tr> <tr> <td>-</td> <td>-</td> </tr> </table>	a)	b)	+	+	+	nc	nc	+ SPWM	-	-	24/48 V DC														
a)	b)																												
+	+																												
+	nc																												
nc	+ SPWM																												
-	-																												
E	on-off, primary side: 230v of the converter	energy saving	combinable with all other installation schemes		24/48 V DC																								

* -SPWM is internally connected to - / ground
nc=not connected

wiring diagrams to switch on/off

wiring diagram type	specific characteristic	application	FLASHAAR® products
S/1 a) 1 x 1CH b) 1 x 1CH	pin type a: secured against reverse polarity: light inserts can be turned, cabling can be carried out with 2 wires (ensure current and cross section), the + and – of the ribbon cable are bridged at the input.	pin type a: all 1-channel light inserts pin type b: mixed operation of S/SPWM/1c or S/SPWM/O	NP Line Mayflower-3, Sta. Maria-6, Victory-7, Navigator-3, Jago-2**, Nova-6**
S/1b & S/PWM/1c 1 x 1CH + 1 x 1CH SPWM	for mixed operation of 1-channel luminaire inserts without separate control input and control pwm luminaire inserts. attention: due to a common voltage supply, mixed operation of 24 v dc and 48 v dc is not possible, the selection of the luminaire inserts to be mixed depends on the common voltage.		NP Line Mayflower-3, Sta. Maria-6, Victory-7, Navigator-3, Jago-2**, Nova-6** NP PicoSpot, NP Focus-4 1CH
S/2 a) 1 x 2CH b) 2 x 1CH	a turning of the light inserts changes the relation to the channel, the non-switched +pole can be jumpered, the feed line can optionally be carried out with 3 wires (ensure current and cross section).	any application with 2 channels (colours) & light inserts without separate control inlet. pin type a: 2-channel light inserts with 3 poles (double +). pin type b: operation of 2 different 1-channel light inserts with two pole connection each.	PIN type a: NP Line Pegasus-4 Gold (future) PIN type b, 1-channel luminaire inserts: NP Line Mayflower-3, Sta. Maria-6, Victory-7, Navigator-3, Jago-2**, Nova-6**
S/3 a) 1 x 3CH b) 1 x 2CH + 1 x 1CH c) 3 x 1CH p) 1 x 1 CH (Pegasus-4) + 1 x 2CH	light inserts can not be turned. channels are encoded, the non-switched pole (usually +) can be jumpered, the feed line can optionally be carried out with 3 wires (ensure current and cross section).	pin type a: 3-channel light inserts with 4 poles. pin type b: parallel operation of 2-channel (3 poles) and 1-channel light inserts (2 poles). pin type c: operating 3 different light inserts 1-channel (2 poles). pin type p: parallel operation of 1-channel (2 poles) and 2-channel luminaire inserts type pegasus-4 (3 poles)	PIN type a: NP Line Defiant PIN type b & c, 1-channel luminaire inserts: NP Line Mayflower-3, Sta. Maria-6, Victory-7, Navigator-3, Jago-2**, Nova-6** PIN type p: NP Line Pegasus-4, additionally look c
S/Pegasus 1 x 2CH	light inserts cannot be rotated, channels are coded, the non-switched + pole can be bridged, the supply cable can be 3-core if necessary	all luminaire inserts NP Pegasus-4	NP Line Pegasus-4
S/SPWM/1 a) 1 x 1CH b) 1 x 1CH	light inserts may not be turned, switch must the control signal either switch between + and – back and forth, or just the + on/off: SPWM to positive=off, SPWM to minus/off=on. supply voltage should also be switched off during longer off-time.	pin type a: all 1-channel light inserts which are dimmed with a PWM control signal for PWM generation on the board pin type b: for operation with three-core supply cable	PIN type a & b: NP Focus-4 1CH NP Focus-4 1CH Darklite NP PicoSpot (24 / 48 V)
S/SPWM/2 2 x 1CH	light inserts may not be turned, switch must the control signal either switch between + and – back and forth, or just the + on/off: SPWM to positive=off, to minus/off=on. supply voltage should also be switched off during longer off-time.	to switch all 1-channel light inserts on 2 channels, which are dimmed with a PWM control signal for PWM generation on the board	NP Focus-4 1CH NP Focus-4 1CH Darklite NP PicoSpot (24 / 48 V)
E	in case of a simple installation the switching of the feed line from PSU to NP system can be spared. in all other installations as well, the primary side of the PSU should be disconnected from the mains when the NP system is off longer.	combinable with all other installation schemes	all products

**For luminaires of length > 1m, piercing contacts (PIN) are installed in both end caps due to the high power.

Verdrahtungsschemata schaltbar

wiring diagrams to switch on/off

WD/S/1

WD/S/1a (1x1CH) Schaltbar, System mit 1 Kanal / 1CH Leuchteneinsätze mit redundanter PIN-Belegung
to switch ON/OFF, system with 1 channel / 1CH light insert with double PIN connection

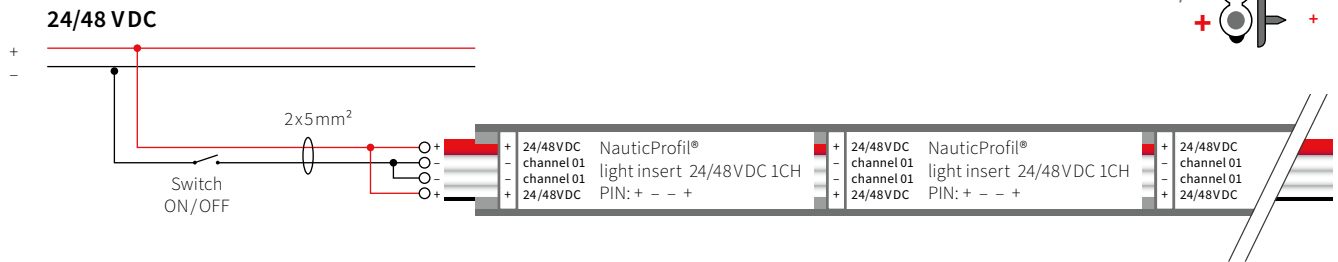

WD/S/1b* (1x1CH) Schaltbar, System mit 1 Kanal / 1CH Leuchteneinsätze ohne redundanter PIN-Belegung
to switch ON/OFF, System with 1 channel / 1CH light insert without double PIN connection

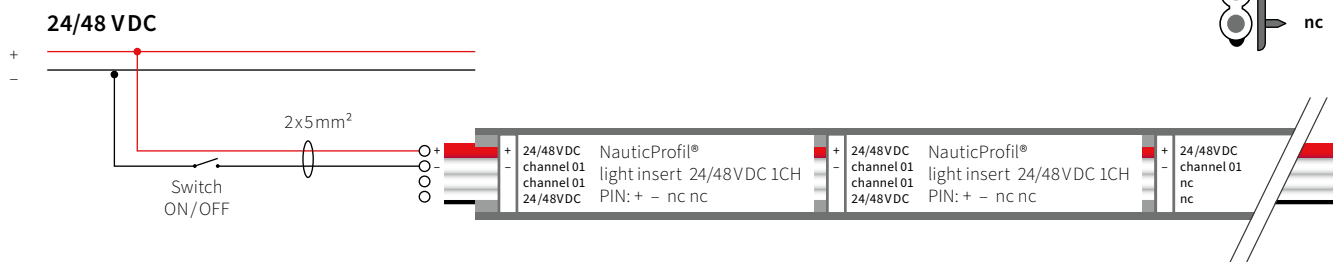

WD/S/1b & WD/S/SPWM/1c (1x1CH + 1x1CH SPWM) Schaltbar, System bestehend aus 1CH NP Leuchteneinsätzen ohne separatem Steuereingang und 1CH NP Leuchteneinsatz schaltbar über SPWM-Signal
switchable, system consisting of 1CH NP luminaire inserts without separate control input and 1CH NP luminaire insert switchable via SPWM signal

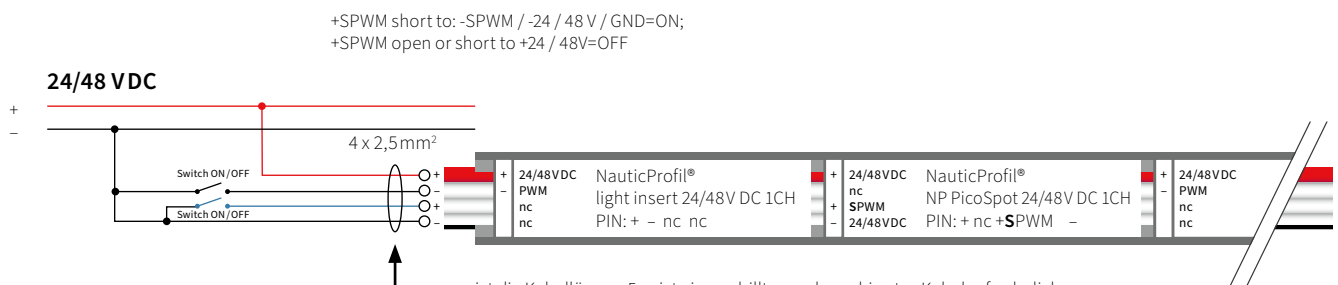

ist die Kabellänge > 5 m ist ein verdrehtes und geschirmtes Kabel erforderlich
if distance >5m a twisted and shielded cable is required

Eine Spannungsversorgung für beide PWM-Dimmer.
One power supply for both PWM dimmers.

24VDC oder 48VDC

Kein Mischbetrieb möglich. Spannung ist abhängig von gewählter NP Line.
Mixed operation isn't possible. The voltage depends on the selected NP Line.

*Bei NP Line Nova und /oder Jago mit der Länge > 1m, werden wegen der hohen Leistung Piercing-Kontakte (PIN) in beiden Endkappen verbaut.
For NP Line Nova an /or Jago with a length > 1m, piercing contacts (PIN) are installed in both end caps due to the high power.

Verdrahtungsschemata schaltbar wiring diagrams to switch on/off

WD/S/2

WD/S/2a (1x2CH)

Schaltbar, System mit 2 Kanälen /
2CH Leuchteneinsätze (z. B. tunable white)
to switch ON/OFF, system with 2 channels /
2CH light insert (e.g. tunable white)

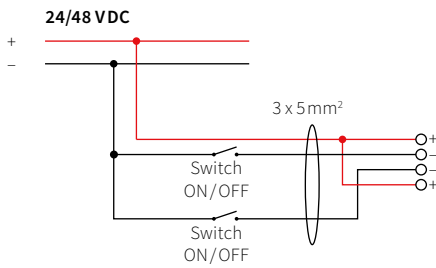
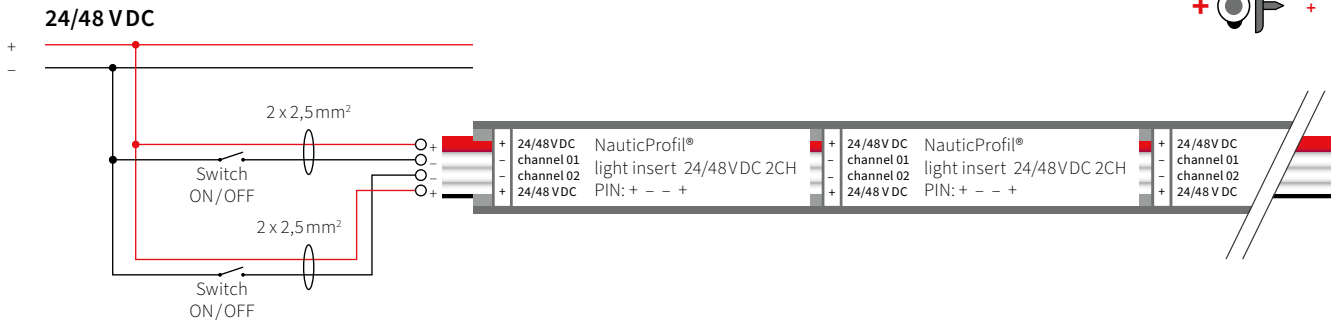
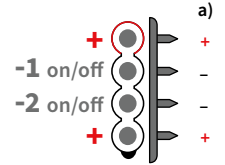

Alternative mit + gebückter Zuleitung kann gegebenenfalls 3-adrig ausgeführt werden, auf Stromstärke und Querschnitt achten!
Alternative with + bridged Feed cable can be 3 wire, please pay attention to current and cross section!

WD/S/2b* (2x1CH)

Schaltbar, System mit 2 Kanälen /
Betrieb von 2 unterschiedlichen 1CH Leuchteneinsätzen
to switch ON/OFF, system with 2 channels /
operating 2 different 1CH light inserts

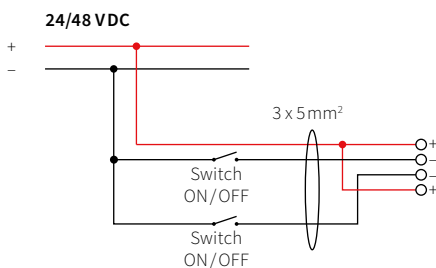
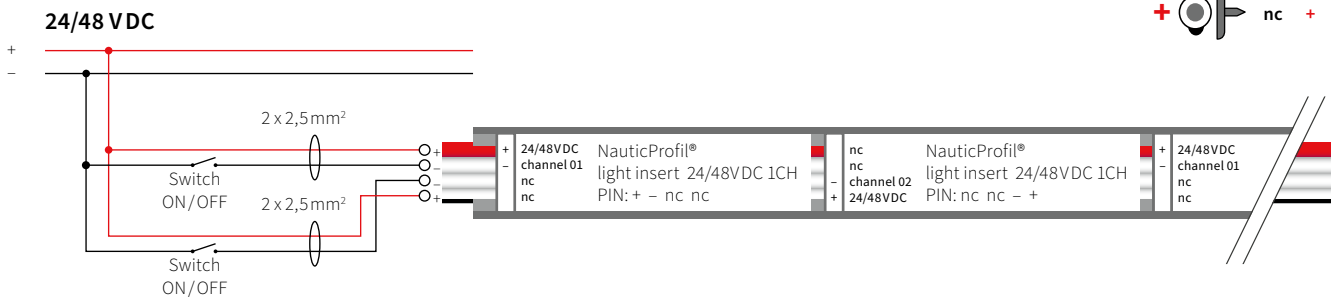
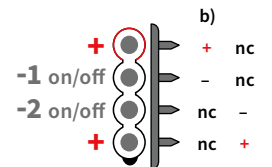

Alternative mit + gebückter Zuleitung kann gegebenenfalls 3-adrig ausgeführt werden, auf Stromstärke und Querschnitt achten!
Alternative with + bridged Feed cable can be 3 wire, please pay attention to current and cross section!

*Bei NP Line Nova und /oder Jago mit der Länge > 1m, werden wegen der hohen Leistung Piercing-Kontakte (PIN) in beiden Endkappen verbaut.
For NP Line Nova an /or Jago with a length > 1m, piercing contacts (PIN) are installed in both end caps due to the high power.

Verdrahtungsschemata schaltbar wiring diagrams to switch on/off

WD/S/3

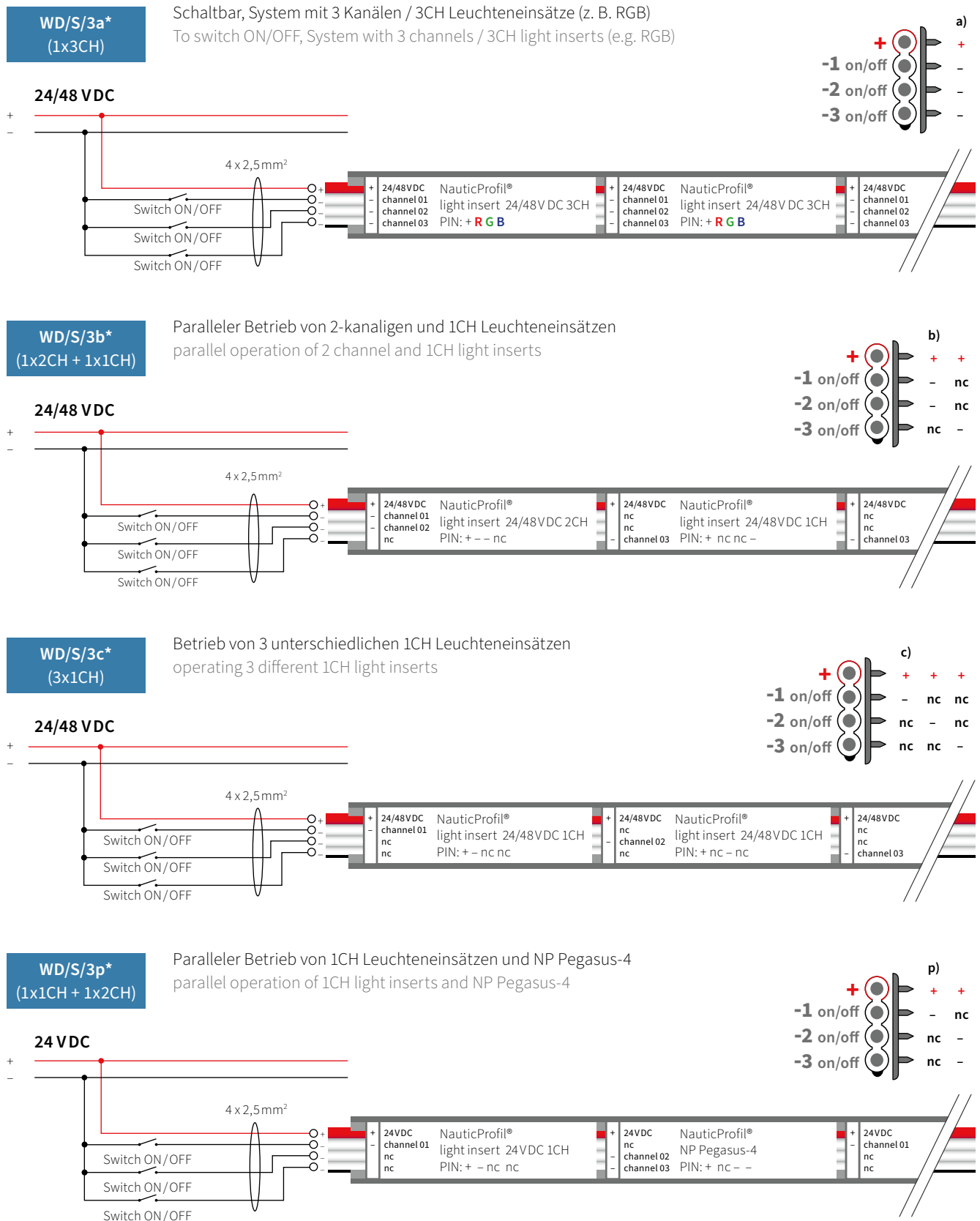

*Bei NP Line Nova und /oder Jago mit der Länge > 1m, werden wegen der hohen Leistung Piercing-Kontakte (PIN) in beiden Endkappen verbaut.
For NP Line Nova an /or Jago with a length > 1m, piercing contacts (PIN) are installed in both end caps due to the high power.



© Landratsamt Esslingen / Martin Duckek

Verdrahtungsschemata schaltbar wiring diagrams to switch on/off

WD/S/Pegasus-4

WD/S/Pegasus
(3x1CH)

Schaltbar, System mit 2 Kanälen/
2CH Leuchteneinsätze Pegasus-4 (z. B. tunable white)
to switch ON/OFF, system with 2 channels/
2CH light insert Pegasus-34 (e.g. tunable white)

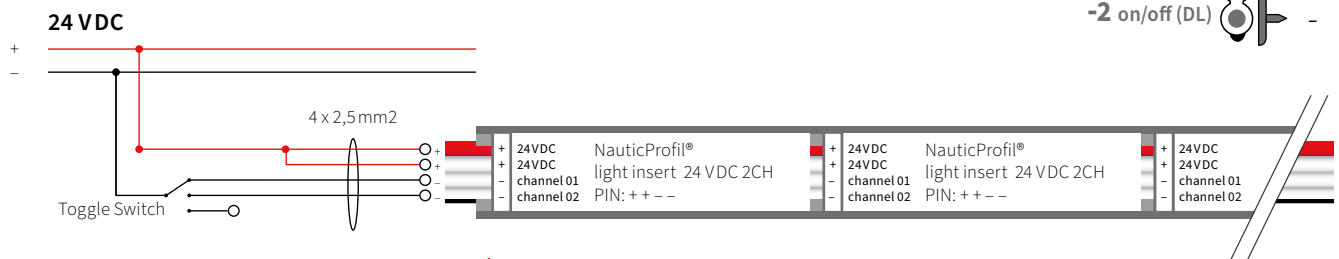

⚠ Achtung! Der Betrieb beider Lichtfarben gleichzeitig auf 100% ist nicht zulässig!
Auf ausreichende Kühlung ist zu achten. Max. 24 W/m Gesamtleistung.

Attention! Operating both light colours at 100% at the same time is not permitted!
Sufficient cooling must be ensured. Maximum total output 24 W/m

Verdrahtungsschemata schaltbar wiring diagrams to switch on/off

WD/S/SPWM/1

WD/S/SPWM/1a (1x1CH)

Schaltbar über SPWM, System mit 1 Kanal, 24VDC /
1CH Leuchteneinsatz / Dimmart: Steuerungs-PWM (SPWM)
Switchable via SPWM, 24VDC single channel system /
1CH Light Insert (monochrome) / Dimming: Signal-PWM
+SPWM short to -SPWM=ON; +SPWM open=OFF

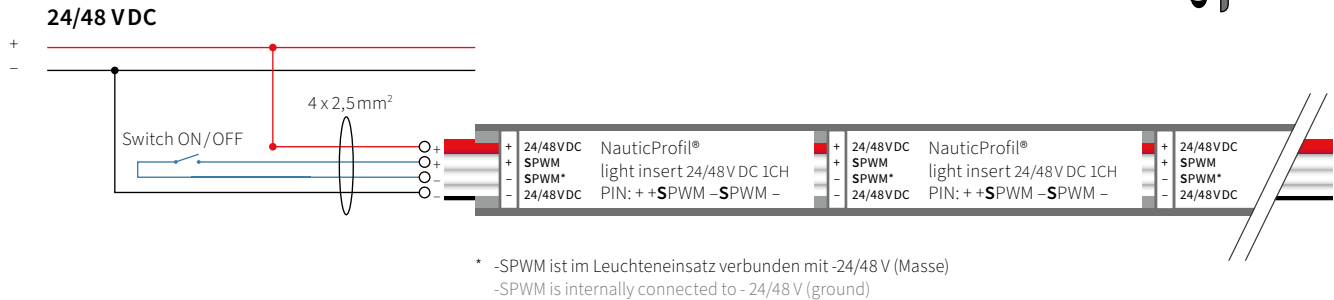
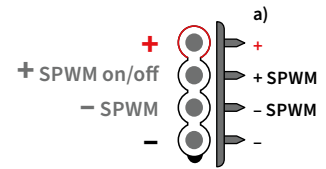

WD/S/SPWM/1b (1x1CH)

Schaltbar über SPWM, System mit 1 Kanal, 24/48VDC /
1CH Leuchteneinsatz / Dimmart: Steuerungs-PWM (SPWM)
Switchable via SPWM, 24/48VDC single channel system /
1CH Light Insert (monochrome) / Dimming: Signal-PWM
+SPWM short to -SPWM=ON; +SPWM open=OFF

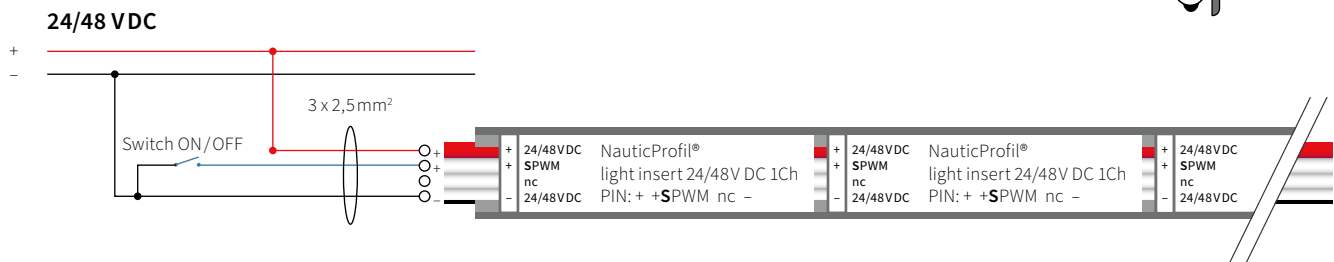
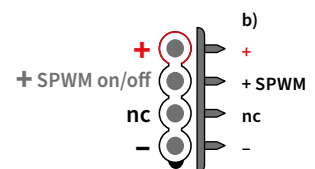

WD/S/SPWM/2

WD/S/SPWM/2 (2x1CH)

zum Schalten aller 1-kanaligen Leuchteinsätze auf 2 Kanälen,
die mit einem PWM-Steuerungssignal für PWM-Erzeugung
auf Platine gedimmt werden.
to switch all 1-channel light inserts on 2 channels, which are
dimmed with a PWM control signal for PWM generation on the board
+SPWM short to -24 V / GND=ON; +SPWM open=OFF

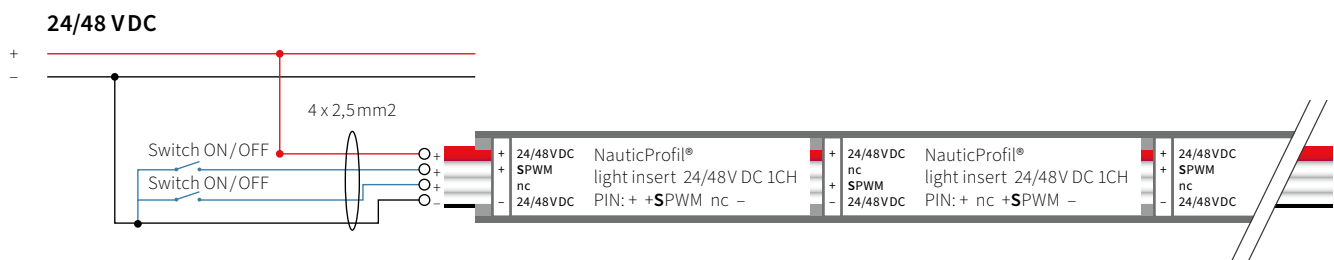
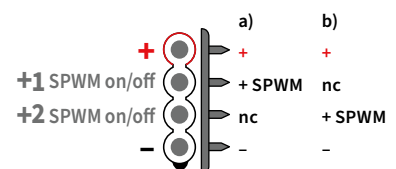



© Besucherterrasse, Stiftung Humboldt Forum, Staatliche Museen zu Berlin – Preußischer Kulturbesitz / Florian Selig

Verdrahtungsschemata schaltbar wiring diagrams to switch on/off

WD/E energiesparend energy saving

WD/E

kombinierbar mit allen anderen Installationsschemata, dringend empfohlen bei längeren Schaltzyklen von SPWM-Installationen; ratsam bei allen anderen Installationen

can be combined with all other installation schemes, strongly recommended for longer switching cycles of SPWM installations; advisable for all other installations

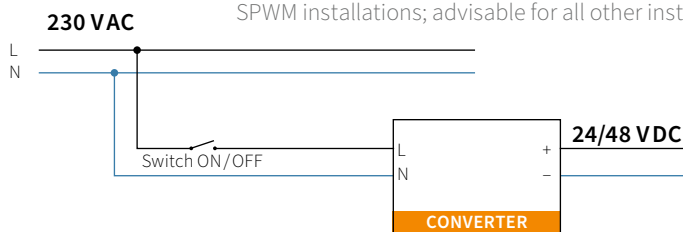



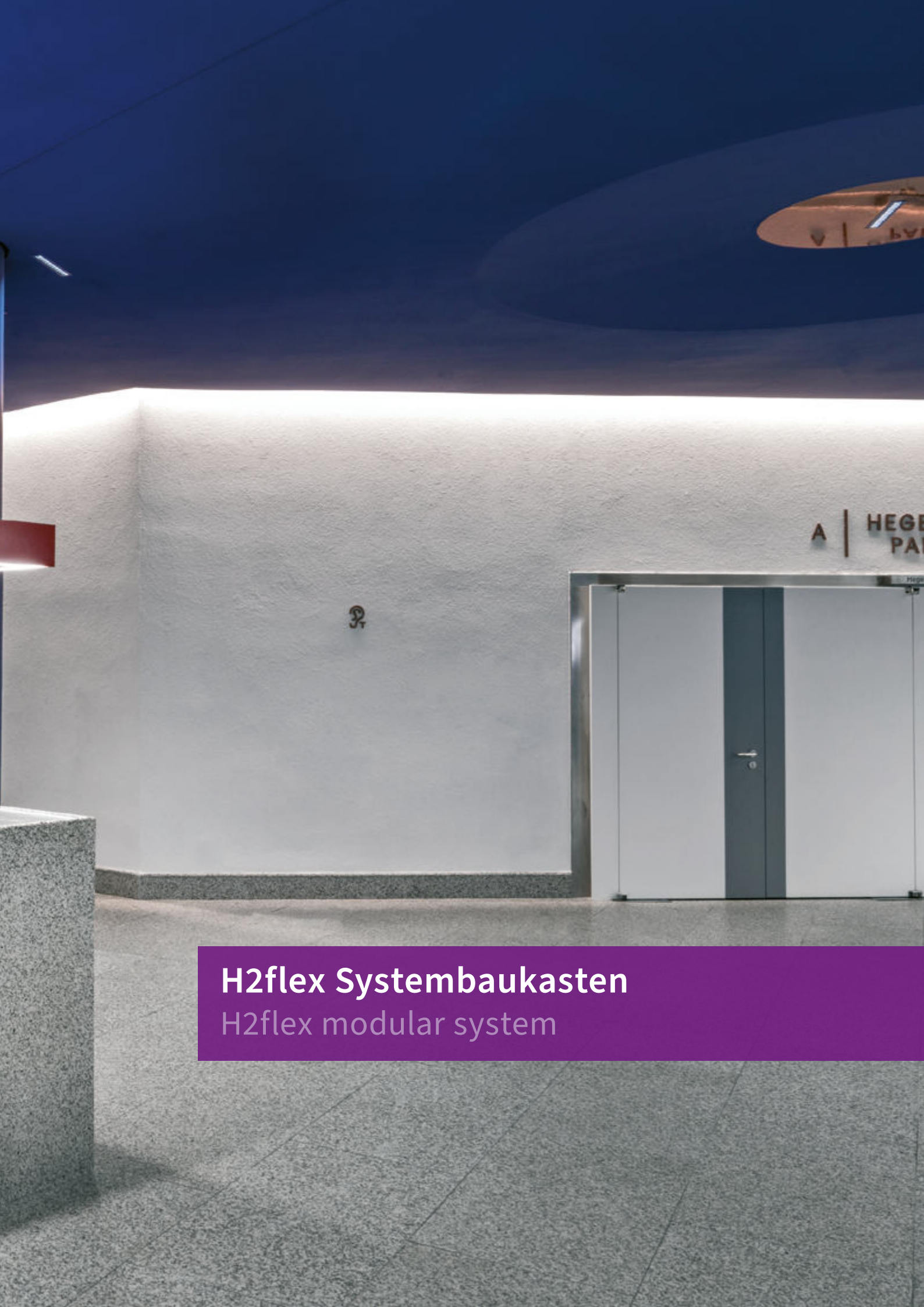

H2flex Systembaukasten

H2flex modular system

H2flex Systembaukasten – Garant für Variantenreichtum

H2flex modular system –
a wealth of product freedom

- 1 H2flex Einschubprofil**
H2flex insert profiles
- 2 H2flex Aufnahmeprofil**
H2flex retain profile
- 3 H2flex Seitenprofil**
H2flex sideprofile
- 4 NP Montageprofile**
NP mounting profiles
- 5 NP Leuchteneinsätze**
NP light inserts

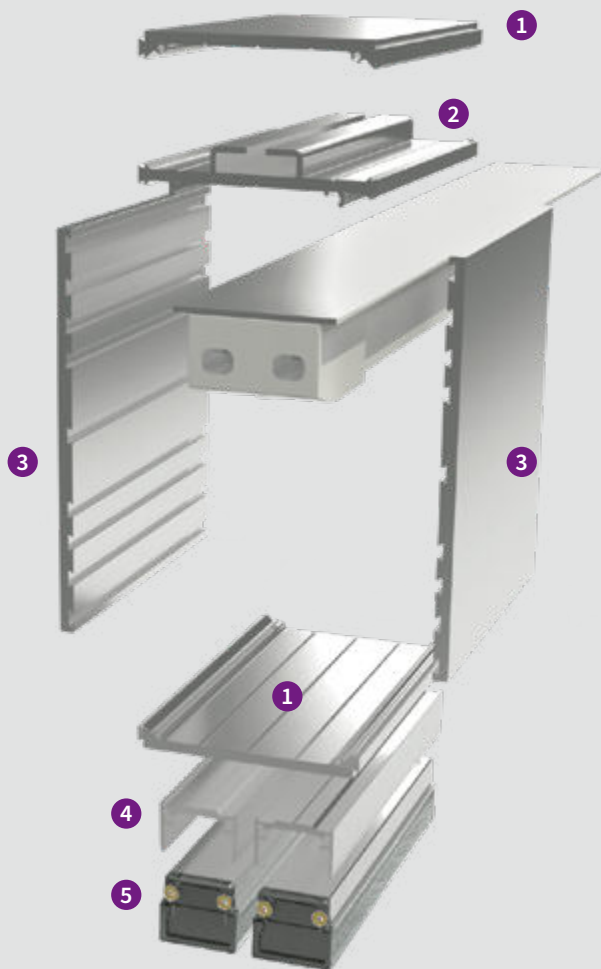

hochwertig | universell | zuverlässig | lichtstark | geradlinig
high-quality | universal | reliable | bright | straightforward

Schlicht in der Form – grandios in der Wirkung

Auf den ersten Blick von außen mutet die H2flex schlicht an: ein wohl proportionierter, rechteckiger Kasten mit beliebiger Länge bis 6000 mm. Im Inneren dagegen zeigt sich die komplexe technische Raffinesse.

Mit wenigen Grundelementen ist aus diesem Systembaukasten alles denkbar, jede Variante machbar.

Aus den verschiedenen H2flex Systemprofilen lässt sich, mit nur wenigen Handgriffen, blitzschnell die nötige Leuchte aus den unzähligen Gehäusevarianten erstellen. Egal, ob direktes oder indirektes Licht, ob an der Wand montiert oder abgependelt von der Decke - alle denkbaren Kombinationen sind möglich.

Simple in form – grandiose in effect

At first glance from the outside, the H2flex looks simple: a well-proportioned, rectangular box in any length up to 6000 mm. Inside, on the other hand, the technical sophistication is evident.

With just a few basic elements, this modular system makes any variant possible.

With the various H2flex system profiles, the required luminaire can be created in a flash from the countless housing variants in just a few steps. Whether direct or indirect light, wall-mounted or suspended from the ceiling - all conceivable combinations are possible.



© FLASHAAR

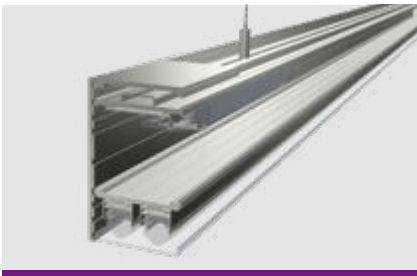

H2flex Systembaukasten

Das H2flex ist ein wohl proportionierter, rechteckiger Systembaukasten, mit individueller Länge (bis max. 6m), aus dessen Grundelementen sich unzählige Leuchtenvarianten bauen lassen.

The H2flex is a well-proportioned, rectangular modular system, with individual lengths (up to max. 6m), from whose basic elements countless luminaire variants can be built.



H2flex Leuchteneinsätze

In unser H2flex lassen sich problemlos unsere linearen NauticProfil® Leuchteneinsätze integrieren. Das Gehäuse bietet genügend Platz, um EVGs mit darin unterzubringen.

Our linear NauticProfil® light inserts can be easily integrated into our H2flex. The housing offers enough space to accommodate electronic ballasts.

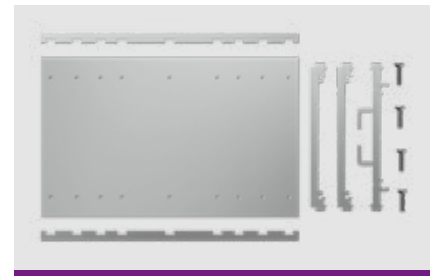

H2flex Zubehör

Das H2flex besteht in der Grundausstattung aus 2 Seitenprofilen, dem Gehäuseboden, einem Einschubprofil zur Aufnahme von LED-Leuchten, einem Cover und den Endplatten.

Wir beraten Sie gern bei individuellen Ausführungen und Anforderungen.

The basic version of the H2flex consists of 2 side profiles, the enclosure base, a slide-in profile for accommodating LED luminaires, a cover and the end plates.

We will be happy to advise you on individual designs and requirements.

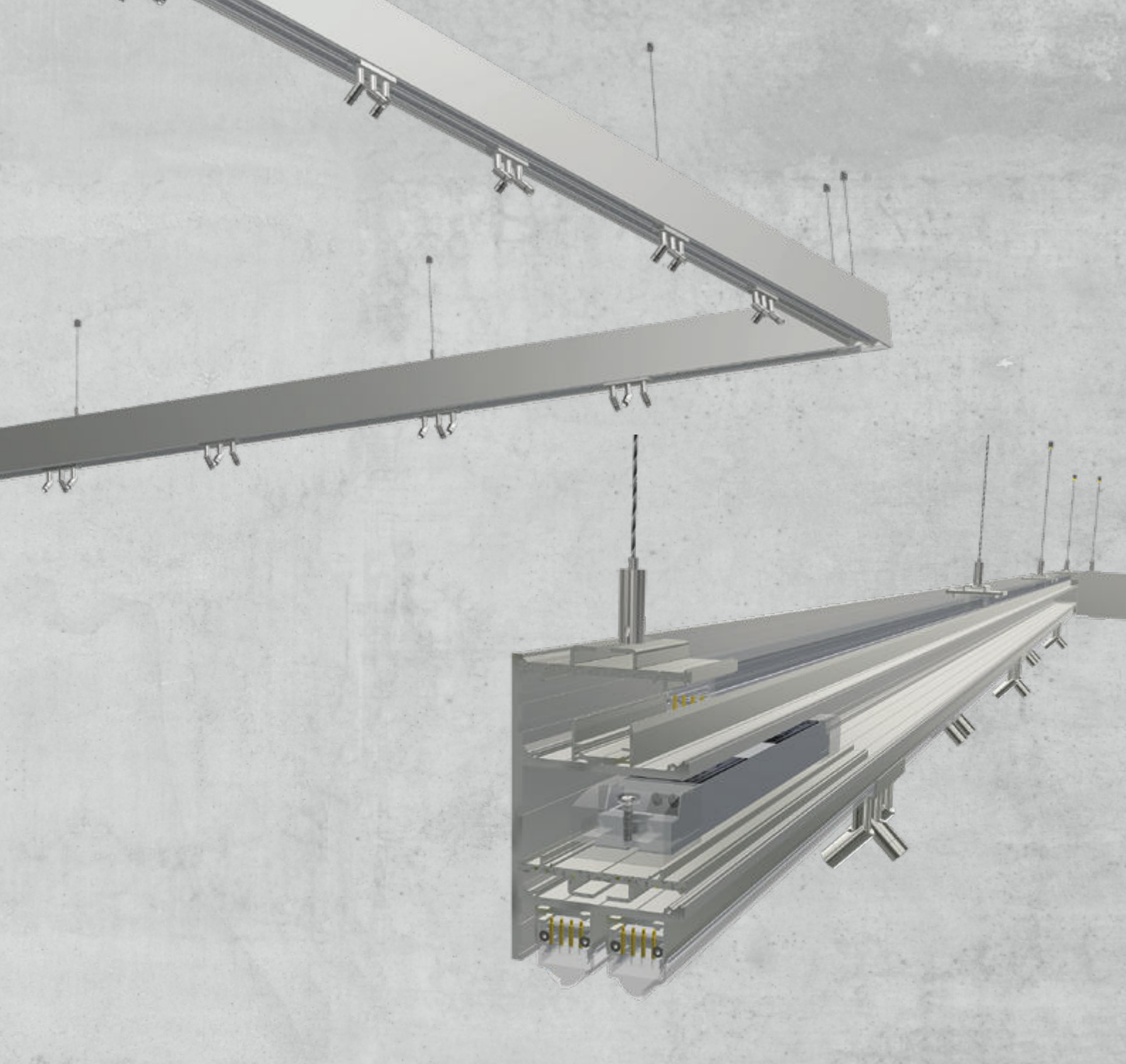

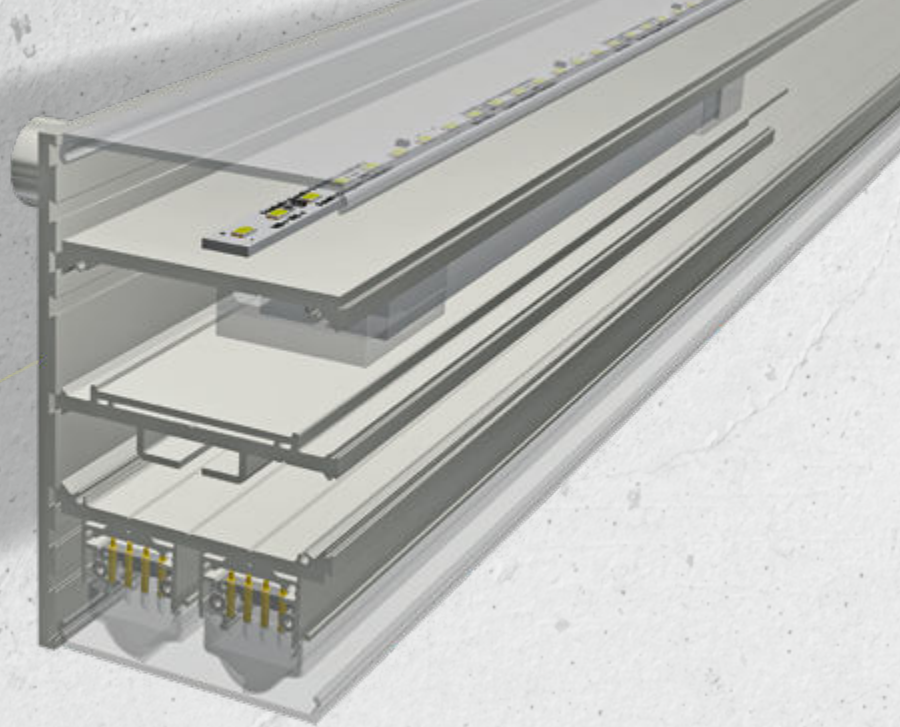

H2flex Systembaukasten: Licht – wie und wo Sie planen

H2flex modular system: light – how and where to plan

H2flex – raumbildender Systembaukasten zwischen Leuchte und Innenausbau

LED-Beleuchtungen werden immer kleiner ... aber was passiert damit in großen Räumen?

Mit diesem Problem konfrontierten uns viele Planer die einerseits das Licht, aber andererseits auch die Innenarchitektur in den Griff bekommen müssen. Hohe, breite Flure, Foyer-Situationen mit offen sichtbaren Decken-Installationen, abgependelte Lichtschienen über großen Tischen...

Andere Planer hatten damit zu kämpfen bei nachträglich geplanten Beleuchtungen zusätzliche Gewerke zu benötigen, um Bauteile abzuändern oder ins Gebäude zu bringen, wie Lichtvouten, Vorsprünge, Ein-/Aufbaukästen...

FLASHAAR® gibt mit dem neuen H2flex Systembaukasten viele Antworten. Verwirrend? Lassen Sie uns das erklären.

Alle denkbaren Kombinationen sind möglich – ob direkt oder indirekt, ob gerichtet, asymmetrisch oder homogen Licht abstrahlend. Ob an der Wand, an der Decke, abgependelt oder diagonal im Raum, als Solitär oder enorme, raumbildende Einheit. Das ist maximale gestalterische Freiheit auf höchstem Niveau dort, wo Innenarchitektur und Lichtgestaltung verschmelzen.

Halt und Stabilität garantieren die präzise verarbeiteten, stranggepressten Aluminium-Profile und Endplatten. Die Oberfläche des H2flex überzeugt in der gewohnt ausgezeichneten Qualität, wahlweise in silber oder schwarz eloxiert, optional auch gepulvert.

H2flex – space-forming modular system between luminaire and completion of the interior

LED lights are getting smaller and smaller ... but what happens to them in large rooms?

We have been confronted with this problem by many planners who have to manage not only the light, but also the interior design. High, wide corridors, foyers with openly visible ceiling installations, suspended light tracks above large tables...

Other planners have had to struggle with the fact that additional trades are required for retrospectively planned lighting in order to modify components or bring them into the building, such as light coves, projections, installation modules...

FLASHAAR® provides many answers with the new H2flex modular system. Confusing? Allow us to explain.

Whether direct or indirect, directional, asymmetrical or homogeneous light, all conceivable combinations are possible: on the wall, on the ceiling, suspended, or diagonally in the room, as a solitaire or an enormous, space-forming unit. This is maximum creative freedom at the highest level where interior and lighting design come together.

The precisely processed extruded aluminium profiles and endplates guarantee hold and stability. The surfaces of the H2flex impress with the usual excellent quality, available anodised in silver or black, with the option of powder-coating.

H2flex

Schlicht in der Form, grandios in der Wirkung – unser H2flex Systembaukasten

DE Auf den ersten Blick von außen mutet die **H2flex** schlicht an, ein wohl proportionierter, rechteckiger Kasten mit beliebiger Länge bis 6000 mm. Im Inneren dagegen zeigt sich die komplexe technische Raffinesse. Mit den Grundelementen ist aus diesem Systembaukasten alles denkbar, jede Variante machbar.

Mit nur wenigen Handgriffen lässt sich aus den verschiedenen H2flex Systemprofilen blitzschnell die nötige aus den unzähligen Gehäusevarianten erstellen.

Simple in form, grandiose in effect – our H2flex modular system

EN At first glance from the outside, the **H2flex** looks simple, a well-proportioned, rectangular box in any length up to 6000 mm. Inside, on the other hand, the technical sophistication is evident. With the basic elements, everything is conceivable from this modular system, every variant is feasible.

With just a few simple steps, the housing variant you need can be created in a flash from the various H2flex system profiles.

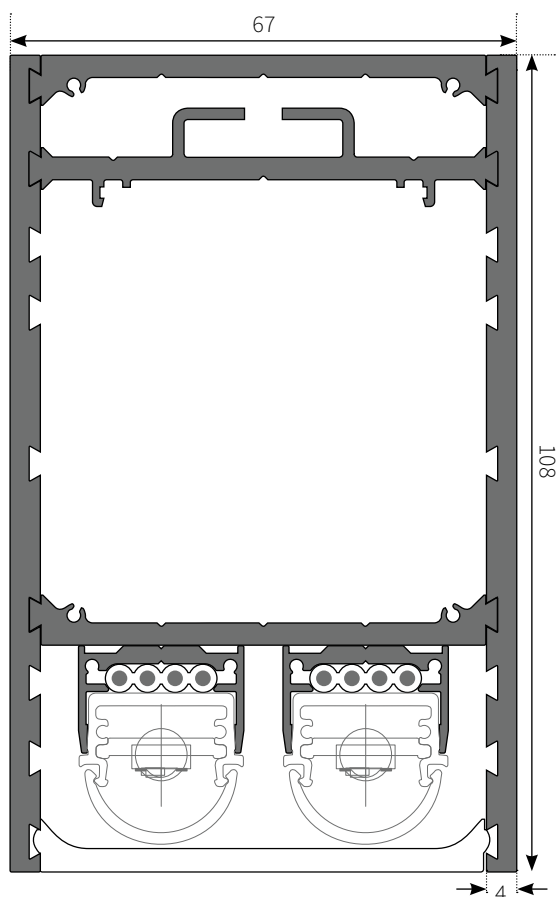

Maßstab 1:1 / Alle Maßangaben in mm.
scale 1:1 / All dimensions in mm.

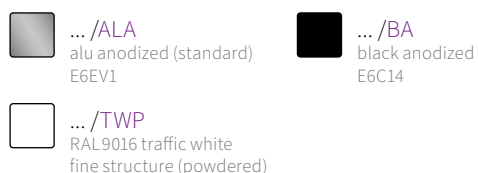

Sonderfarben auf Anfrage! Special colours on request!

Bitte bei NP Profil- und Endplatten-Bestellung die Art.Nr. um die gewünschte Farbe ergänzen. Bei gewünschtem Gehrungsschnitt die Art.Nr. um die Gradzahl, bei Bestellung des NP Flachkabels die Art.Nr. um die entsprechende Länge (mm) ergänzen. Bitte beachten Sie unser Formular für NauticProfil® Eck-Konfigurationen im Katalog und unter www.flashaar.de

Please state the required colour with the article number when ordering NP profiles and end plates. Please state the required angle with the article number when ordering bevel cuts and state the corresponding length (mm) with the article number when ordering NP flat cables. Please take note of our form for NauticProfil® corner-connections and also at www.flashaar.de



Montagehinweis installation note

H2flex wird kombiniert aus H2flex Seitenprofil (in der Regel zwei, jeweils links und rechts eins), H2flex Einschubprofil 1 (in der Regel um LED-Leuchten und Komponenten im Systemträger zu montieren oder als kantenbündiger Deckel zu verwenden), H2flex Einschubprofil 2 (in der Regel um EVG und Abhänger zu montieren), H2flex Cover flat (falls Abdeckung von LED-Leuchten und Komponenten gewünscht ist), Endplatte als Abschluss und zur Versteifung, sowie nach Wahl Abhänger-Sets oder Montagezubehör.

Mittels Schwalbenschwanzführung werden die H2flex-Systemträger auf der geplanten Höhenposition in die Systemwände eingeschoben, die Leuchten z. B. aus unserer NauticProfil® Serie montiert, EVGs und Endkappen eingesetzt, verkabelt und das ganze mit speziellem Montagematerial abgehängt oder angebaut. Kein zusätzliches Sägen, Schleifen, Schmieren, Streichen oder weitere Gewerke auf der Baustelle.

Lesen Sie hier zunächst drei Anwendungsbeispiele, lassen Sie sich beraten oder fordern Sie sich unser Starterkit an und probieren Sie es selber aus:

- H2flex Seitenprofil
- H2flex Einschubprofil 1 (LED/Gehäuseboden)
- H2flex Einschubprofil 2 (EVG/Befestigung)
- H2flex Cover flat (PMMA weiß)

H2flex is a combination of H2flex side profiles (usually two, one left and one right), H2flex slide-in profile 1 (usually to mount LED lights and components in the system bracket, or to be used as a flush edge cover), H2flex slide-in profile 2 (usually to mount ECGs and hangers), H2flex Cover flat (if LED lights and components are to be covered), endplate as termination and for stiffening, as well as hanger sets or mounting accessories of your choice.

By means of dovetail guides, the H2flex system beams are inserted into the system walls at the planned height, the lights e.g. from our NauticProfil® series are mounted, ECGs and end caps are inserted, wired and the whole thing suspended or mounted with special mounting material. No additional sawing, grinding, lubricating, painting or other works on the construction site.

Read three application examples here, get advice, or request our starter kit and try it out for yourself:

- H2flex side profile
- H2flex slide-in profile 1 (LED/housing base)
- H2flex slide-in profile 2 (ECG/attachment)
- H2flex Cover flat (white PMMA)

Aufhängung suspension



Symbolbild
symbolic

NP/PENDANT2

Stahlseilabhangung und Anschlussleitung
(ohne Baldachin)
steel pendant set and connection cable
(without canopy)

Artikel, Zubehor und Optionen articles, accessories and options

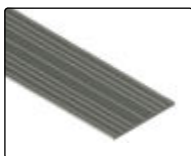

FLH2X/SP1/510/ALA/###
(0510 /1010 /2010 oder 3020 x 108 x 4 mm)
H2flex Aluminium Seitenprofil, 2 Stuck notwendig
H2flex aluminium sideprofile, 2 pieces necessary



FLH2X/IN1/###
(0510 /1010 /2010 oder 3020 x 61,9 x 6,76 mm)
H2flex Aluminium Einschubprofil, 2 Stuck notwendig
H2flex aluminium insert profile, 2 pieces necessary



FLH2X/IN2/###
(0510 /1010 /2010 oder 3020 x 61,9 x 13 mm)
H2flex Aluminium Aufnahmeprofil
H2flex aluminium retain profile



FLH2X/EP1/###
(108 x 67 x 4 mm)
Aluminium Endplatte fur Montageprofil H2flex
Aluminium endplate for mounting profile H2flex



FLH2X/CSW/2010/###
(4100 x 60,4 x 6,0 x 1,8 mm)
Abdeckung fur Montageprofil H2flex
cover square white for mounting profile H2flex

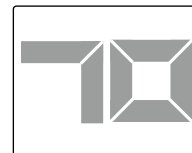

FL/B-CUT
Gehrungsschnitt fur L-, U- oder Q-Konfiguration
bevel cut for L-, U- or Q-configuration

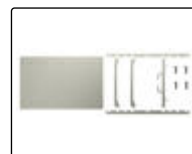

FLH2X/STARTERKIT
Muster in 300 mm
Pattern in 300 mm



FLNP/FCable-UV
(4x2,5/3,45 mm²/0,122 kg/m)
NP Flachkabel 4 x 2,5mm², UV-bestandig
NP flat cable 4 x 2,5mm², UV resistant



Anwendung 1 – der repräsentative Flur application 1 – the representative hallway

Machen Sie die Augen zu und stellen Sie sich vor:

Altbau, Beletage, ein Flur, 4-Meter-sechzig Deckenhöhe, rund 2-Meter-zwanzig breit, wunderbare Proportionen, Stucco, Wände und Decke in Weiß mit einem Stich ins sonnige und honiggelbes Eichen-Parkett in Fischgrätmuster, geschlossene Sideboards zur Aktenablage mit spärlich gestellten Vasen und Antiquitäten sowie Bilder an der Wand, ziemlich lang und ein 90° Knick verbinden den Eingang mit Empfang, Besprechungs- und Anwaltszimmer. Wie lösen wir die Aufhellung der Decke, die Beleuchtung der Wände, setzen Spitzlichter auf die Objekte und schaffen eine gute Strukturierung der Höhe?

Die Lösung:

Auf 3 Meter abgependelte H2flex, am Knick des Flures auf Gehrung gearbeitet, ohne Abdeckscheibe, nach unten zwei NauticProfil® S1, bestückt abwechselnd mit 2-Meter-Stücken Victory-6, neutralweiß, Lens Asymmetric zur Wand gerichtet und PicoSpot³, ebenfalls neutralweiß mit Spotlinse transparent (links und rechts sind symmetrisch versetzt, so dass die PicoSpots jeweils mittig zu den Victory-7 liegen). Nach oben trägt die H2flex ein NauticProfil® mittig, bestückt mit Navigator, ebenfalls neutralweiß und einfachem runden Cover frosted, unterbrochen nur von den Abhängern. Alle EVGs sind im Profil untergebracht und alles ist silber eloxiert. Außer den Abhängern etwa alle 2 Meter – die Abhängung der H2flex kann statisch unbedenklich einfach an die Stuckdecke angepasst werden – und einer einzigen zentralen Stromzuführung ist kein Eingriff in die Bausubstanz nötig.

Close your eyes and imagine:

A period house, Beletage, a corridor, four metre sixty ceiling height, about two twenty wide, wonderful proportions, stucco, walls and ceiling in white with an engraving in the sunny and honey-yellow oak parquet in herringbone pattern, closed sideboards for filing with sparsely placed vases and antiques as well as pictures on the wall, quite long and a 90° bend connects the entrance with reception, meeting room and lawyer's office. How do we illuminate the ceiling and walls, set spotlights on the objects, and create a good height structure?

The solution:

H2flex suspended at 3 m, mitred at the bend of the corridor, without cover plate, two NauticProfil® S1 facing downwards, fitted alternately with 2 m Victory-5 pieces, neutral white, Lens Asymmetric directed towards the wall and PicoSpot⁴, also neutral white with transparent spot lens (left and right are offset symmetrically, so that the PicoSpots are centred on the Victory-7). Facing upwards, the H2flex carries a NauticProfil® in the middle, equipped with navigator, also neutral white, and a simple round Cover frosted, interrupted only by the hangers. All ECGs are housed in the profile and everything is anodised in silver. Apart from the hangers every 2 metres – the suspension of the H2flex can be easily adapted to the stucco ceiling in a statically harmless manner – and a single central power supply system does not require any changes to the building structure.



Anwendung 2 – Foyer in Glas und Beton

application 2 – foyer in glass and concrete

Das Entree einer Firma wurde saniert:

Das 70er Jahre Gebäude aus Beton hat im Eingangsbereich seine abgehängte Decke verloren. In den Weiten der Fläche schaffte der Architekt Inseln mit individuell abgehängten Bereichen und Bodenbelägen. Dazwischen ist die blanke Decke, 5,40 m hoch mit 60 cm Unterzügen und offener Installation frei zu sehen, wenn auch alles in tiefschwarz, matt gehalten ist. Ebenfalls schwarze Akustiksegel sind lose verteilt. Wie beleuchten wir den in leichtem Zickzack verlaufenden Weg, deutlich am helleren Teppich zu erkennen vom Eingang zum hinten gelegenen Empfangstresen?

Die Lösung:

Auf 3,80 Meter abgependelte H2flex, an den Knicken des Laufweges auf Abstand gesetzt. Klare Abdeckscheibe unten und zwei NauticProfil® S1 deutlich zurückgesetzt, bestückt mit Nova-6, neutralweiß, Lens 30° frosted. Nach oben trägt die H2flex keine Leuchte. Alle EVGs sind im Profil untergebracht und alles ist silbern eloxiert. Außer den Abhängern etwa alle 2 Meter – die Abhängung der H2flex kann statisch unbedenklich einfach an die Decke angepasst werden – und einer einzigen zentralen Stromzuführung ist kein Eingriff in die Bausubstanz nötig.

The entrance to a company was renovated:

the concrete building from the 70s lost its suspended ceiling in the entrance area. The architect created islands with individual suspended areas and floor coverings in the wide expanse. In between, the bare ceiling, 5.40m high with 60 cm beams and open installation, is clearly visible, although everything is in deep, matt black. Black acoustic sails are also loosely distributed. How do we illuminate the slightly zigzagging path, clearly recognisable by the lighter carpet, from the entrance to the reception counter at the back?

The solution: H2flex suspended at 3.80 metres, set at a distance from the bends of the walkway. A clear cover pane at the bottom and two NauticProfil® S1 clearly set back, fitted with Nova-6, neutral white, Lens 30° frosted. The H2flex does not have any upward-facing lights. All ECGs are housed in the profile and everything is anodised in silver. Apart from the hangers every 2 metres – the suspension of the H2flex can be easily adapted to the ceiling in a statically harmless manner – and a single central power supply system does not require any changes to the building structure.



Anwendung 3 – Das Loft der Kunstsammlerin

application 3 – The art collector's loft

Klischee, aber wahr:

Wände uneben, zum Teil mit altem Putz, roh, Backstein, hoher großer leerer Raum, große Wandscheiben, bestückt mit Gemälden und Grafiken, aber nie feinkomponiert, sondern mehr so „working in progress“, Sie kennen das.

Sie wünscht sich da was an Licht. Die Decke kommt, wenn die Sonne weg ist, „auch immer so runter“ und es soll schon sauber sein, die Wände sind ja nun lebendig genug.

Die Lösung:

Auf 2,20 Meter Höhe werden an den Wänden entlang – auf Abstandshaltern von rund 10 cm, welche die Unebenheiten ausgleichen – H2flex montiert. Schwarz eloxiert. Nach unten hat die Leuchte ein klares Cover flat und nach oben ein diffuses Cover flat. Unten ist sie bestückt mit einem NauticProfil® S1 direkt hinter der Scheibe, von der Wand weggerückt, bestückt mit Victory-7, warmweiß 3000 K, Lens Asymmetric zur Wand gerichtet. Oben ist die H2flex direkt auf dem Einschubprofil einfach mit LED-Platinen des Typs Nova-6, ebenfalls 3000 K bestückt und mit gutem Abstand zum Cover montiert. Alle Netzteile und Dimmer sind im Profil untergebracht.

Cliché, but true:

uneven walls, partly with old plaster, raw, brick, high, large, empty room, large wall panels, decorated with paintings and graphics, but never finely composed, more of a „work in progress“, you know it.

She wants something done with light. When the sun is gone, the ceiling seems lower. The lighting should be clean, as the walls are lively enough.

The solution:

H2flex, mounted at a height of 2.20 metres along the walls, on spacers of around 10 cm which compensate for the unevenness. It is anodised in black and has a clear Cover flat facing downwards and a diffuse Cover flat facing upwards. Below, it is equipped with a NauticProfil® S1 directly behind the pane, moved away from the wall, fitted with Victory-7, warm white 3000 K, Lens Asymmetric facing the wall. Above, the H2flex is mounted directly on the slide-in profile with Nova-6 LED boards, also equipped with 3000 K and mounted at a good distance from the Cover. All power supplies and dimmers are housed in the profile.



Self-Portrait-Flagship Store

Für die Beleuchtung des Self-Portrait Store in London wurden NP Line Navigator Leuchten mit 4000 K hinter einer offenen Rasterdecke eingesetzt. Dadurch wird eine durchgängig gleichmäßige, helle und unaufdringliche Beleuchtung erzielt, welche die eleganten Designer-Kleider stilgerecht präsentiert.

For the lighting of the Self-Portrait store in London, NP Line Navigator luminaires with 4000 K were used behind an open grid ceiling. This provides consistent, bright and unobtrusive lighting throughout, showcasing the elegant designer clothes in style.

H2flex U1

Stabiles Profil mit Raum für größtmögliche Flexibilität

DE Das neue H2flex U1 bringt mehr Licht in hohe und große Räume. Dieses schlichte, extrem stabile Profil wurde ursprünglich für ein Projekt entwickelt und entspricht einer der gefragtesten Konfigurationen unseres H2flex Systembaukastens. Das H2flex U1 zeichnet sich durch seine sehr hohe Steifigkeit aus. Dies gewährleistet eine stabile und präzise Installation sowie zahlreiche Möglichkeiten die perfekte Beleuchtungslösung für Ihr Projekt zu bieten.

Stable profile with room for maximum flexibility

EN The new H2flex U1 brings more light into high and large rooms. This simple, extremely stable profile was originally developed for a project and corresponded to one of the most sought-after configurations of our H2flex modular system. The H2flex U1 is characterised by its very high rigidity. This ensures a stable and precise installation and numerous possibilities to provide the perfect lighting solution for your project.

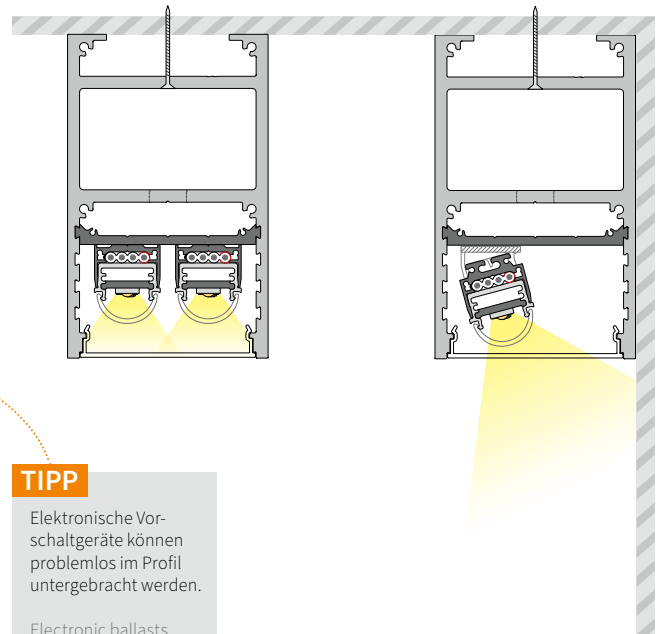
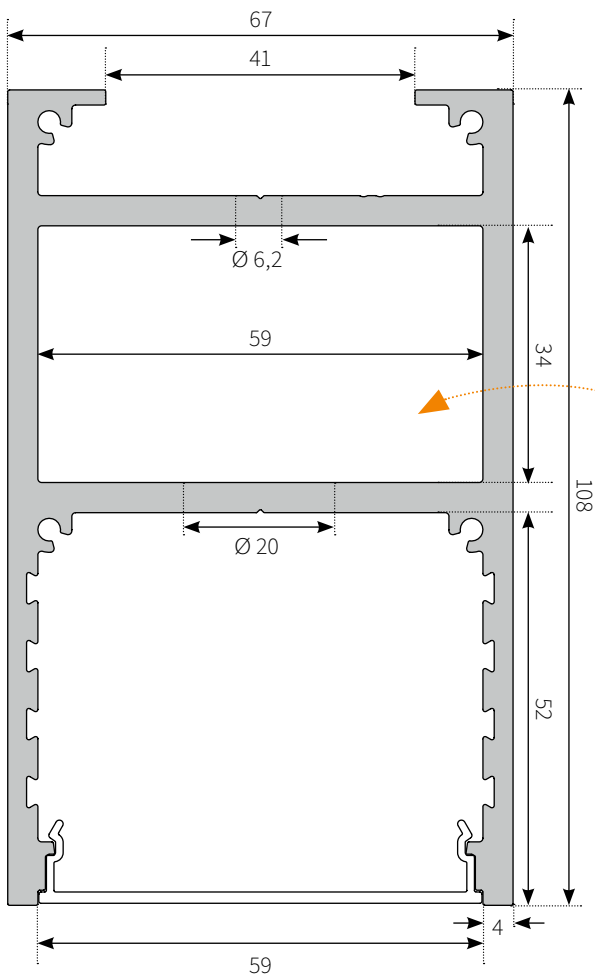

TIPP
Elektronische Vorschaltgeräte können problemlos im Profil untergebracht werden.
Electronic ballasts can be easily accommodated in the profile.



Maßstab 1:1 / Alle Maßangaben in mm.
scale 1:1 / All dimensions in mm.

- ... /ALA
alu anodized (standard)
E6EV1
- ... /BA
black anodized
E6C14
- ... /TWP
RAL9016 traffic white
fine structure (powdered)

Sonderfarben auf Anfrage! Special colours on request!

Bitte bei NP Profil- und Endplatten-Bestellung die Art.Nr. um die gewünschte Farbe ergänzen. Bei gewünschtem Gehrungsschnitt die Art.Nr. um die Gradzahl, bei Bestellung des NP Flachkabels die Art.Nr. um die entsprechende Länge (mm) ergänzen. Bitte beachten Sie unser Formular für NauticProfil® Eck-Konfigurationen im Katalog und unter www.flashaar.de

Please state the required colour with the article number when ordering NP profiles and end plates. Please state the required angle with the article number when ordering bevel cuts and state the corresponding length (mm) with the article number when ordering NP flat cables. Please take note of our form for NauticProfil® corner-connections and also at www.flashaar.de

Zwei Systeme vereint – mehr Raum für Ihre Ideen Two systems combined - more space for your ideas

DE Das FLASHAAR® nicht nur schmale LED Linien kann, beweisen wir mit unserem H2flex Systembaukasten. Projektspezifisch waren lange, aber auch breite Lichtlinien gefordert, die besonders in hohen oder großen Räumen mehr Licht erzeugen. Aus diesem Grund haben wir aus einer der beliebtesten Konfigurationen des H2flex das neue **H2flex U1** entwickelt.

Entstanden ist ein, in sich extrem stabiler Leuchtenkörper aus stranggepresstem, eloxiertem Aluminium, der sich nur minimalst durchbiegt. Dadurch wird eine präzise Installation sowie eine absolut verlässliche Beleuchtungslösung gewährleistet.

Das gewohnt schlichte und hochwertige Design lässt sich in zahlreiche Anwendungsbereiche und Umgebungen integrieren. Egal ob an Wand, Decke oder Boden montiert – die klare Linienführung schafft eine zeitlose und moderne Atmosphäre.

Ein besonderes Highlight ist das eigens dafür entworfene Abdeckcover in Weiß. Die diffuse und transparente Oberfläche sorgt für eine gleichmäßige Lichtverteilung ohne unerwünschte Blendeffekte. Für Anwendungen bei denen ein UGR<19 erforderlich ist, bieten wir für unser H2flex U1 ein Cover mit einer mikroprismatischen Prägung. Das Ergebnis ist eine gezielte, aber dennoch absolut blendfreie Beleuchtung – ideal für den Einsatz in Büroräumen, Empfangsbereichen oder an Arbeitsplätzen in Industrie und Handwerk.

Das H2flex U1 bietet genügend Platz, um div. Netzteile und Betriebsgeräte direkt darin zu verstauen. Das Profil wird mit perfekt abgestimmten Zubehör geliefert, um Ihre Installation zu optimieren. Leuchtmittel aus dem NauticProfil® Systembaukasten lassen sich, dank der zahlreichen Befestigungselementen und Montageclips, im H2flex U1 individuell integrieren. Wir bieten Ihnen alles, was Sie für eine reibungslose und professionelle Montage benötigen. Gleichzeitig können Sie auf das Zubehör des H2flex Systembaukastens zurückgreifen.

Dieses multifunktionale H2flex U1 vereint beide Systeme und bietet Flexibilität in der gewohnten Qualität. Mit nur wenigen Handgriffen lässt sich für Ihr Projekt die passende Leuchte bauen – zahlreiche Kombinationen lassen Raum für Ihre Kreativität.

EN Our H2flex modular system proves that FLASHAAR® can do more than just narrow LED lines. Project-specific long, but also wide light lines were in demand, which creates more light, especially in high or large rooms. For this reason, we developed the new **H2flex U1** from one of the most popular configurations of the H2flex.

The result is an extremely stable luminaire body made of extruded, anodised aluminium that bends only minimally. This ensures precise installation and an absolutely reliable lighting solution.

The familiar simple and high-quality design can be integrated into numerous areas of application and environments. Whether on the wall, ceiling or floor - the clean lines create a timeless and modern atmosphere.

A special highlight is a specially designed cover in white. The diffuse and transparent surface ensures uniform light distribution without unwanted glare. For applications where a UGR<19 is required, we offer a cover with a micro prismatic embossing for our H2flex U1. The result is targeted, yet absolutely glare-free lighting - ideal for use in offices, reception areas or workplaces in industry and trade.

The H2flex U1 offers enough space to store various main cables and control gear directly in it. The profile is supplied with perfectly matched accessories to optimise your installation. Luminaires from the NauticProfil® modular system can be individually integrated into the H2flex U1 thanks to the numerous fastening elements and mounting clips. We offer you everything you need for a smooth and professional installation. At the same time, you can use the accessories of the H2flex modular system.

This multifunctional H2flex U1 combines both systems and offers flexibility in the usual quality. The right luminaire can be built for your project in just a few steps - numerous combinations leave room for your creativity.



Artikel, Zubehör und Optionen articles, accessories and options



FLH2X/U1/2010/###/ALA
(0510 / 1010 / 2010 / 3000 / 6000 x 108 x 67 mm)
H2flex U1 Aluminium Montageprofil
H2flex U1 aluminium mounting profile



FLH2X/U1/EP/###
(108 x 67 x 4 mm)
Aluminium Endplatte für Montageprofil H2flex U1
Aluminium endplate for mounting profile H2flex U1



FLH2X/U1/###/4100
(4100 x 60,4 x 6,0 x 1,8 mm)
Abdeckung für Montageprofil H2flex U1
cover for mounting profile H2flex U1

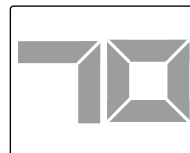

FL/B-CUT
Gehrungsschnitt für L-, U- oder Q-Konfiguration
bevel cut for L-, U- or Q-configuration



FLNP/FCable-UV
(4x2,5/3,45 mm²/0,122 kg/m)
NP Flachkabel 4 x 2,5mm², UV-beständig
NP flat cable 4 x 2,5mm², UV resistant





LED Spotleuchten

LED spot lights

FLASHAAR® LED Spots und Strahler – für Innen und Außen

FLASHAAR® LED spots and spotlights – for indoors and outdoors



extrem robust | hochwertig | lichtstark | fokussiert
extremely robust | high-quality | light-intensive | focused

Herausragende und effiziente LED-Spots im kompakten oder minimalistischen Design

Ganz egal, ob in Innen- oder Außenräumen, an Wänden, Hausfassaden, Gärten, Terrassen, Skulpturen oder Ausstellungsstücken – mit unseren effizienten LED-Spots, im minimalistischen oder kompakten Design, lassen sich wunderschöne und imposante Lichtakzente erzeugen.

Mit RGB werden Fassaden in ein farbiges Lichtkunstwerk verwandelt, wohingegen weiße LED Spots einzelne Objekte gezielt in Szene setzen.

Outstanding and efficient LED spotlights in compact or minimalist design

No matter whether indoors or outdoors, on walls, house facades, gardens, terraces, sculptures or exhibits - with our efficient LED spots, in a minimalist or compact design, beautiful and impressive lighting accents can be created.

With RGB, facades are transformed into a colourful work of light art, while white LED spots specifically highlight individual objects.



© Sonderleuchten für die Korallenvitrine in der Ozeanien Ausstellung des Ethnologischen Museums (Bootskubus) / Florian Selig

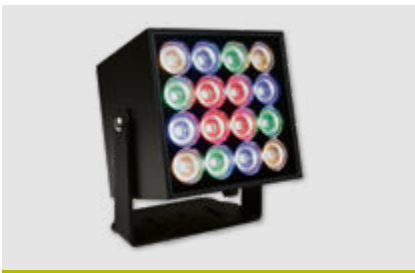

Die **Solaris-2** ist ein herausragender und effizienter LED-Spot im kompakten, quadratischen Design. Mit ihm lassen sich wunderschöne, farbige Lichtakzente im Garten, auf der Terrasse oder am Haus erzeugen.

The **Solaris-2** is an outstanding and efficient LED spotlight in a compact, square design. It can be used to create beautiful, coloured light accents in the garden, on the terrace or at the house.

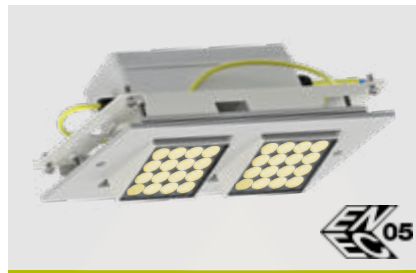

Unsere ENEC zertifizierte **DB-Bahnsteigleuchte** ist eine projektspezifische Spotleuchte, die speziell für die Montage in das Bahnsteigdach (Modell-Typ Hamburg) am Hauptbahnhof Frankfurt entwickelt wurde.

Our ENEC certified **DB platform luminaire** is a project-specific luminaire that was specially developed for installation in the platform roof (Hamburg model type) at Frankfurt Central Station.

Solaris-2 4CH



1031 lm** | CRI > 80/90 | 2700 K – 4000 K + RGB

RGBW-Spot, für Innen- und Außenanwendungen geeignet
 RGBW-spot, suitable for indoor and outdoor applications

Die **Solaris-2** ist ein herausragender und effizienter LED-Spot in einem kompakten Design. Entwickelt für die vertikale Beleuchtung von Fassaden im Innen- und Außenbereich, lässt sie sich in jede Architektur dezent integrieren. Durch unterschiedliche Konfigurationen lässt sich die Solaris-2 an das jeweilige Anforderungsprofil des Kunden anpassen.

Weiche bis messerscharfe Lichtspots: Die Abstrahlcharakteristik der Solaris-2 lässt sich durch verschiedene Linsen genau definieren. Die vier Kanäle der Solaris-2 ermöglichen es, unterschiedliche Lichtszenen bzw. Farbwechsel darzustellen. Die Abdeckscheibe des Spots besteht aus thermisch gehärtetem Glas welches keramisch bedruckt ist.

The **Solaris-2** is an outstanding and efficient LED spotlight in a compact design. Developed for the vertical illumination of indoor and outdoor facades, it can be discreetly integrated into any architecture. Different configurations allow the Solaris-2 to be adapted to the customer's specific requirements profile.

Soft to razor-sharp spotlights: the beam characteristics of the Solaris-2 can be precisely defined using different lenses. The four channels of the Solaris-2 make it possible to create different light scenes or colour changes. The spotlight's cover pane is made of ceramic-printed thermally tempered glass.



effektvolles Lichtspiel an Fassaden, auf Bühnen und Ausstellungsflächen

effective play of light on facades, on stages and exhibition areas

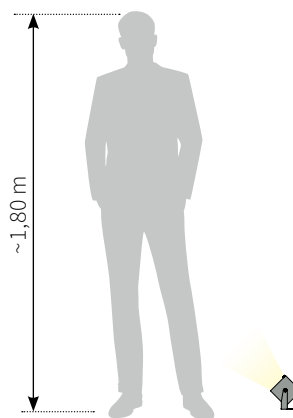

klein + kompakt
 small + compact

Stecker, IP66/IP68, 5-polig mit 25 cm Kabel und 10 m separater Zuleitung.
 connector IP66/68, 5-contacts with 25 cm cable and 10 m separate supply-cable.

characteristics				dimming		optional		mounting			

* Optional mittels Steuereinheit. Optional with control unit.
 ** Alle Angaben zum Lumenstrom beziehen sich auf das Leuchtmittel. In Kombination mit Cover/Linsen kommt es zu materialbedingtem Lichtverlust.
 All information about the luminous flux refers to the light source. In combination with covers / lenses it comes to material-related light loss.

Bestellnummer
item number

FL/SO-2/4C / 0100 / RGBW / LSST/RS / BA

Technische Daten technical data

operating current: typ. 350 mA (max. 700 mA)
nominal wattage: depending on light colour per channel,
e.g. red: 3,1W, green: 4,5W,
blue: 4,3W, white: 4,2W
photometric code: 927/339 (for white) + RGB
LED service life: L80/B10 72000h, L90/B10 34000h
dimming: constant current pulse-width
modulation (CC PWM)

Optionen options

Optional mit Wabenraaster zwischen Linsen und Abdeckscheibe für maximale Entblendung erhältlich. Best.-Nr.: FL/SO-2/HGB

Optionally available with a honeycomb louver between lenses and cover lens for maximum glare control.
item number: FL/SO-2/HGB

Netzteile und Steuereinheiten power supplies and control units

Netzteile und Steuereinheiten im IP-geschützten Gehäuse (IP66/67):
Solaris-2 DALI PSU IP66/67 4CH DT6 insg. 700 mA max.
Anschlussbox zur Steuerung der 4 Kanäle mittels DALI DT8,
teilt die Leistung zwischen den Kanälen,
empfohlen für RGBW-Anwendungen
Bestellnummer FL/CC-4C/DALI/PSU/DT8/700

Power supplies and control units in IP protected housing (IP66/67):
Connection box for controlling the 4 channels using DALI DT8,
divides the power between the channels, recommended for
RGBW applications
item Number: FL/CC-4C/DALI/PSU/DT8/700



⚠ Einbausituation: von unten nach oben leuchtend
Installation situation: luminous from bottom to top





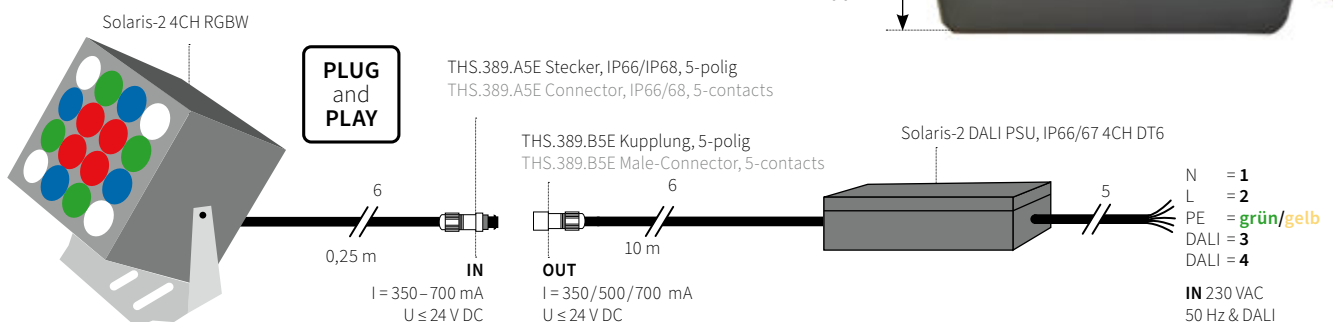
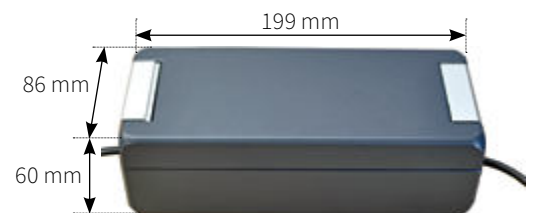



Zuleitungskabel (Kupplung 5-polig) bitte separat bestellen.

Please order supply cables (male-connector 5-contacts) separately.
10 m, inkl. THS.389.B5E / Bestellnr. item nr.: SO/PC/10/THS389B5E





Für das Gesamtwärmemanagement der Leuchte wird keine Gewährleistung übernommen. Unzureichende Wärmeableitung kann die Leuchtdioden oder andere Bauelemente schädigen oder zerstören. Eine hinreichende Wärmeableitung der LED Module ist durch geeignete Maßnahmen (differenzieller Betrieb der Kanäle) sicherzustellen. Betrieb der Leuchte nur mit einer der technischen Spezifikation entsprechenden Stromversorgung. Max. 700 mA je Kanal bei differenziellem Betrieb (nicht alle Kanäle gleichzeitig auf 100%). Bei Dauerbetrieb aller 4 Kanäle mit DALI DT6 Dimmer auf 100% empfiehlt sich eine dauerhafte max. Bestromung zwischen 350 mA, je nach Umgebungstemperatur.
No warranty is provided for overall heat management. Insufficient heat dissipation may damage or destroy the light-emitting diodes and other components. Suitable measures must be implemented to ensure sufficient dissipation of the heat from the LED modules (varying channel usage). The luminaire may only be used with an electric power supply that complies with the technical specifications. Max. 700 mA per channel when the channels are used at different levels (not all channels simultaneously at 100%). For continuous operation of all 4 channels to 100% with DALI DT6 dimmer, a permanent max. current between 350 mA, depending on ambient temperature, is recommended.

Linsen lenses

 LSST/RS Heidi-RS 7° lens symmetric spot transparent 7° real spot	 LSSD/D Heidi-D 8° lens symmetric spot transparent 8° diffuser	 LSTT/SS Heidi-SS 14° lens symmetric tight transparent 14° smooth spot	 LSMT/M Heidi-M 28° lens symmetric medium transparent 28° medium
 LSLT/W Heidi-W 32° lens symmetric large transparent 32° wide	 LSWT/W2 Heidi-W2 44° lens symmetric wide transparent 44° wide	 LSOT/O Heidi-O 50°x9° lens symmetric oval transparent 50°x9° oval	 LATT/O90 Heidi-O90 8°x50° lens symmetric oval transparent 8°x50° oval 90°

Gehäusefarben housing colours

Die Solaris-2 ist wahlweise in folgenden Gehäusefarben erhältlich:
The Solaris-2 is available in the following housing colours:

 ALA alu anodized (standard) E6EV1	 BA black anodized E6C14	 TWP RAL9016 traffic white fine structure (powdered)
---	--	--

Verdrahtungsschemata wiring diagrams

D/CC/4/350/DALI-DT6

Version mit max. 350 mA Konstantstrom pro Kanal, DALI DT6 Dimmung
version with max. 350 mA constant current per channel DT6 dimming

Die dargestellte Buchse THS.389.A5E, 5-polig, mit 25cm Kabel ist Bestandteil der Leuchtenlieferung.
The shown female connector THS.389.A5E, 5-pole, with 25cm cable is part of the luminaire delivery.

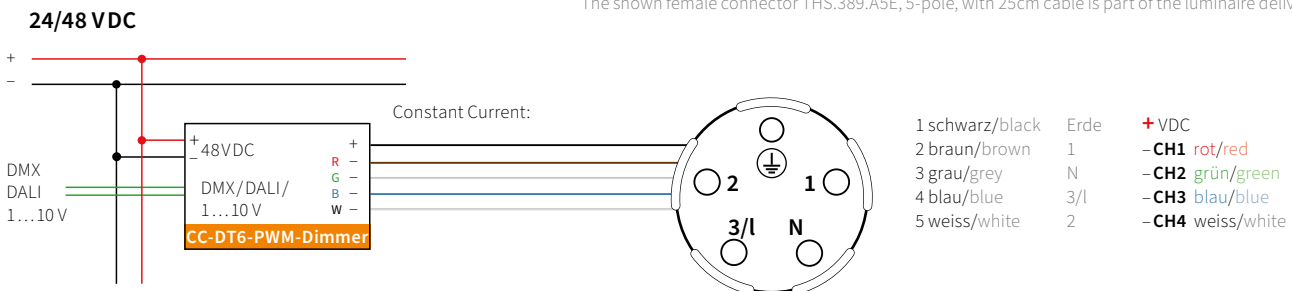

⚠ Beachten Sie die Unterlagen der anzuschließenden Leuchte zum zulässigen Konstantstrom und der zulässigen Gesamtleistung. Die aus thermischen Gründen zulässige Leistung der Summe aller Kanäle ist meist geringer, als die nominelle, elektronische Gesamtleistung aller Kanäle bei 100%. Wir empfehlen daher DALI DT6 Dimmer mit Loadbalancing.

Observe the documents of the luminaire to be connected regarding the permissible constant current and the permissible total power. For thermal reasons, the permissible power of the sum of all channels is usually lower than the nominal, electronic total power of all channels at 100%. We therefore recommend DALI DT6 dimmers with load balancing.

D/CC/4/700/DALI-DT8

Version mit max. 700 mA Konstantstrom pro Kanal, DALI DT8 Dimmung
version with max. 700 mA constant current per channel DT8 dimming

Die dargestellte Buchse THS.389.A5E, 5-polig, mit 25cm Kabel ist Bestandteil der Leuchtenlieferung.
The shown female connector THS.389.A5E, 5-pole, with 25cm cable is part of the luminaire delivery.

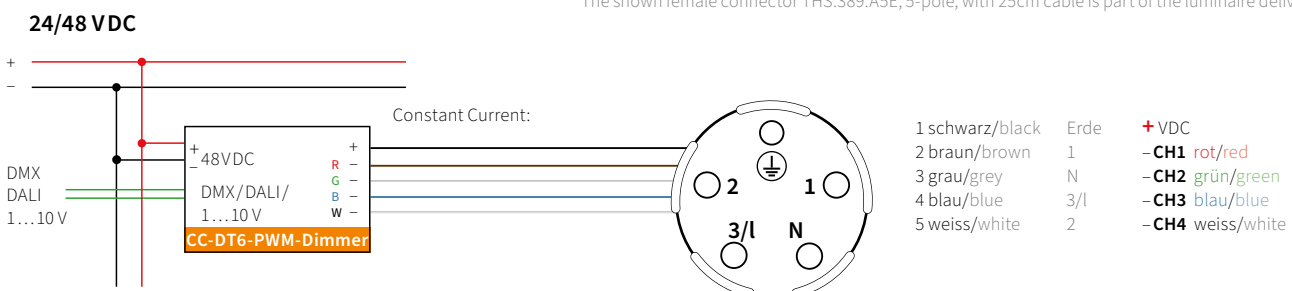

⚠ Beachten Sie die Unterlagen der anzuschließenden Leuchte zum zulässigen Konstantstrom und der zulässigen Gesamtleistung.
Observe the documents of the luminaire to be connected regarding the permissible constant current and the permissible total power.

Konfigurationen Solaris-2 4CH

configurations Solaris-2 4CH

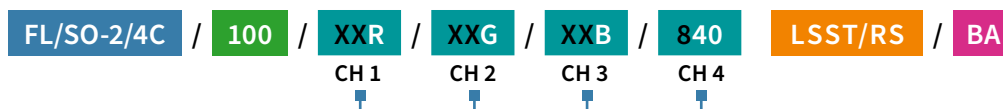

type	CH 1 I=350 mA	CH 2 I=350 mA	CH 3 I=350 mA	CH 4 I=350 mA
4CH, RGB-927	red 620-630nm, 224 lm	green 520-525nm, 404 lm	royal blue 450-456nm, 83lm	2700K, CRI>90, 304 lm
	X X R	X X G	X X B	9 2 7
4CH, RGB-930	red 620-630nm, 224 lm	green 520-525nm, 404 lm	royal blue 450-456nm, 83lm	3000K, CRI>90, 332 lm
	X X R	X X G	X X B	9 3 0
4CH, RGB-840	red 620-630nm, 224 lm	green 520-525nm, 404 lm	royal blue 450-456nm, 83lm	4000K, CRI>80, 469 lm
	X X R	X X G	X X B	8 4 0
4CH, blue	royal blue 450-456nm, 83lm	royal blue 450-456nm, 83lm	royal blue 450-456nm, 83lm	royal blue 450-456nm, 83lm
	X X B	X X B	X X B	X X B
4CH, 2700K, CRI > 90	2700K, CRI>90, 304 lm	2700K, CRI>90, 304 lm	2700K, CRI>90, 304 lm	2700K, CRI>90, 304 lm
	9 2 7	9 2 7	9 2 7	9 2 7
4CH, 3000K, CRI > 90	3000K, CRI>90, 332 lm	3000K, CRI>90, 332 lm	3000K, CRI>90, 332 lm	3000K, CRI>90, 332 lm
	9 3 0	9 3 0	9 3 0	9 3 0
4CH, 4000K, CRI > 80	4000K, CRI>80, 469 lm	4000K, CRI>80, 469 lm	4000K, CRI>80, 469 lm	4000K, CRI>80, 469 lm
	8 4 0	8 4 0	8 4 0	8 4 0

Sonderausführung Solaris-2 4CH e-zoom

special version Solaris-2 4CH e-zoom

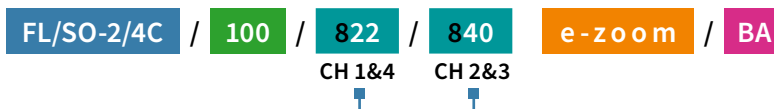

Die Solaris-2 4CH **e-zoom** ist eine Sonderausführung, bei der die vier Kanäle abwechselnd mit einer 8° Real-Spotlinse LSST/RS und einer 44° Weit-Linse LSWT/W bestückt sind. Durch gezielte Ansteuerung dieser Kanäle kann die Leuchte elektronisch zoomen und den Abstrahlwinkel per Steuerung ändern. Da die 4 Kanäle auf die zwei Linsen aufgeteilt sind, macht die farbige Bestückung nur als monochromatische oder 2-kanalige Ausführung Sinn.

















The Solaris-2 4CH **e-zoom** is a special edition in which the four channels are alternately equipped with a 8° real-spotlens LSST/RS and a 44° wide lens LSWT/W. Through targeted control of these channels, the luminaire can zoom electronically and you can change the beam angle through the control. Since the 4 channels are divided between the two lenses, the color arrangement only makes sense as a monochromatic or 2-channel version.

type	CH 1&4	CH 2&3
4CH, 927 + 930	2700 K, CRI > 90, (304 + 304lm/m) 9 2 7	3000 K, CRI > 90, (322 + 322lm/m) 9 3 0
4CH, 927 + 840	2700 K, CRI > 90, (304 + 304lm/m) 9 2 7	4000 K, CRI > 80, (469 + 469lm/m) 8 4 0
4CH, 927	2700 K, CRI > 90, 2 x 304lm/m 9 2 7	2700 K, CRI > 90, 2 x 304lm/m 9 2 7
4CH, 840	4000 K, CRI > 80, 2 x 469lm/m 8 4 0	4000 K, CRI > 80, 2 x 469lm/m 8 4 0

Bei Bestellungen die Artikelnummer um die gewünschte Lichtfarbe ergänzen, sowie um den Bestellvermerk „**e-Zoom**“.

When ordering please complete the item number with the desired light colour, as well as the order note “**e-Zoom**”.

* Beispiele, beliebige Zweier-Kombinationen der Farben XXR, XXG, XXB, 822, 927, 939, 840 möglich, Werte siehe Konfigurationen 4CH.
Examples, any combinations of two colors XXR, XXG, XXB, 822, 927, 939, 840 possible, for values see configurations 4CH.

Präzisionslinse precision lense	R	G	B	W
  Heidi-RS 7° lens symmetric spot transparent 7° real spot	318 lm/m	459 lm/m	137 lm/m	346 lm/m
  Heidi-D 8° lens symmetric spot transparent 8° diffuser	297 lm/m	423 lm/m	119 lm/m	333 lm/m
  Heidi-SS 14° lens symmetric tight transparent 14° smooth spot	299 lm/m	424 lm/m	111 lm/m	335 lm/m
  Heidi-M 28° lens symmetric medium transparent 28° medium	297 lm/m	427 lm/m	107 lm/m	336 lm/m
  Heidi-W 32° lens symmetric large transparent 32° wide	295 lm/m	431 lm/m	113 lm/m	336 lm/m
  Heidi-W2 44° lens symmetric wide transparent 44° wide	270 lm/m	392 lm/m	99,5 lm/m	320 lm/m
  Heidi-O 50°x9° lens symmetric oval transparent 50°x9° oval	298 lm/m	438 lm/m	127 lm/m	353 lm/m
  Heidi-O90 8°x50° lens symmetric oval transparent 8°x50° oval 90°	285 lm/m	438 lm/m	118 lm/m	334 lm/m

















— 0/180°
— 90/270°

Alle lichttechnischen Daten – vermessen im FLASHAAR® Lichtlabor – finden Sie unter flashaar.de im Download-Bereich.

Alle Messwerte unterliegen den typischen Toleranzen.

All photometric data – measured in FLASHAAR's light laboratory – available at flashaar.de/en in the download area.

All measured values are subject to the typical tolerances.

Präzisionslinse precision lens	R	G	B	W
  Heidi-RS 7° lens symmetric spot transparent 7° real spot	534 lm/m	700 lm/m	236 lm/m	545 lm/m
  Heidi-D 8° lens symmetric spot transparent 8° diffuser	499 lm/m	645 lm/m	205 lm/m	524 lm/m
  Heidi-SS 14° lens symmetric tight transparent 14° smooth spot	502 lm/m	647 lm/m	191 lm/m	527 lm/m
  Heidi-M 28° lens symmetric medium transparent 28° medium	499 lm/m	651 lm/m	184 lm/m	529 lm/m
  Heidi-W 32° lens symmetric large transparent 32° wide	495 lm/m	657 lm/m	194 lm/m	529 lm/m
  Heidi-W2 44° lens symmetric wide transparent 44° wide	455 lm/m	598 lm/m	171 lm/m	504 lm/m
  Heidi-O 50°x9° lens symmetric oval transparent 50°x9° oval	500 lm/m	668 lm/m	218 lm/m	556 lm/m
  Heidi-O90 8°x50° lens symmetric oval transparent 8°x50° oval 90°	478 lm/m	668 lm/m	203 lm/m	526 lm/m

— 0/180°
— 90/270°

Alle lichttechnischen Daten – vermessen im FLASHAAR® Lichtlabor – finden Sie unter flashaar.de im Download-Bereich.
 Alle Messwerte unterliegen den typischen Toleranzen.
 All photometric data – measured in FLASHAAR's light laboratory – available at flashaar.de/en in the download area.
 All measured values are subject to the typical tolerances.



Großer Saal der Elbphilharmonie in Hamburg

Die gekonnte Lichtinszenierung unterstützt den harmonischen Wechsel zwischen den Wohlfühl- und Erlebnisbereichen. Kundenindividuell gewählten Lichtfarbenbestückung, tauchen die Wände in ein warmes, farbiges Licht und verstärken die emotionale Atmosphäre des Raumes. Einen weiteren farbigen Akzent setzen die RGB-Leuchten in den Lichtkuppeln.

Great Hall of the Elbphilharmonie in Hamburg

Over 800 FLASHAAR NauticProfil luminaires have been integrated into the steps of the great hall, highlighting the terracing of the tiers. Special luminaires based on the FLASHAAR HighPower-Profile were installed all around the top of the central acoustic reflector and illuminate the vault.

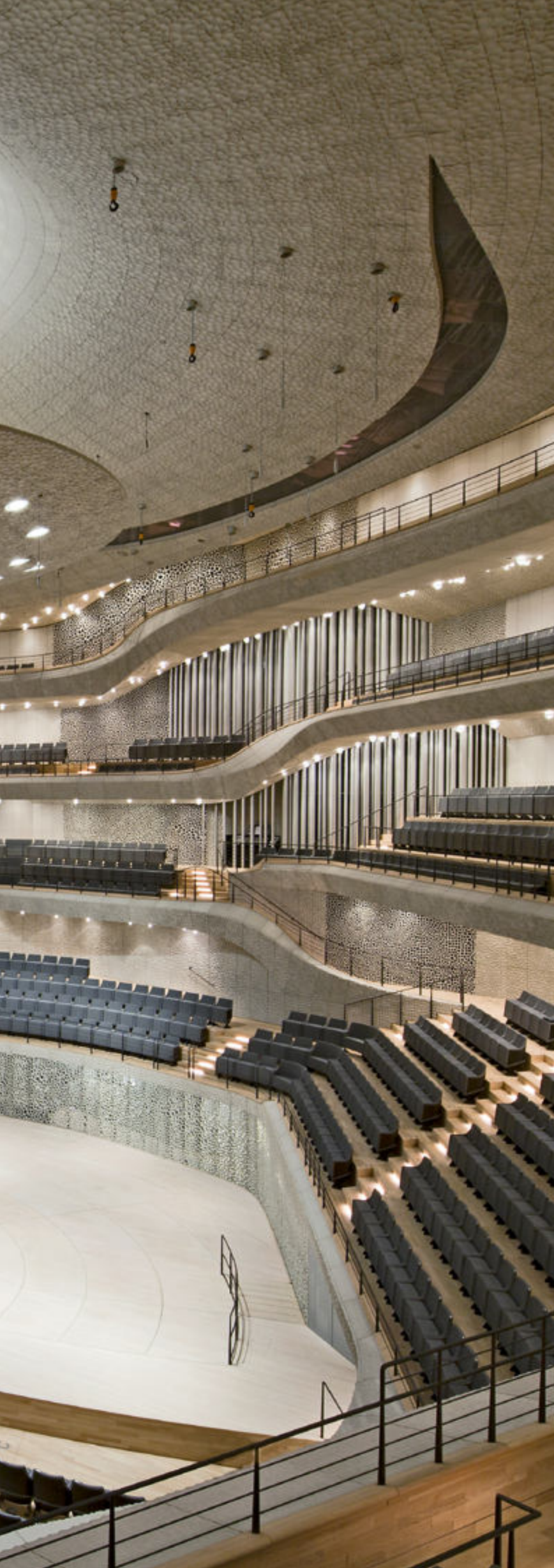

DB/Bahnsteigleuchte

DB / platform light

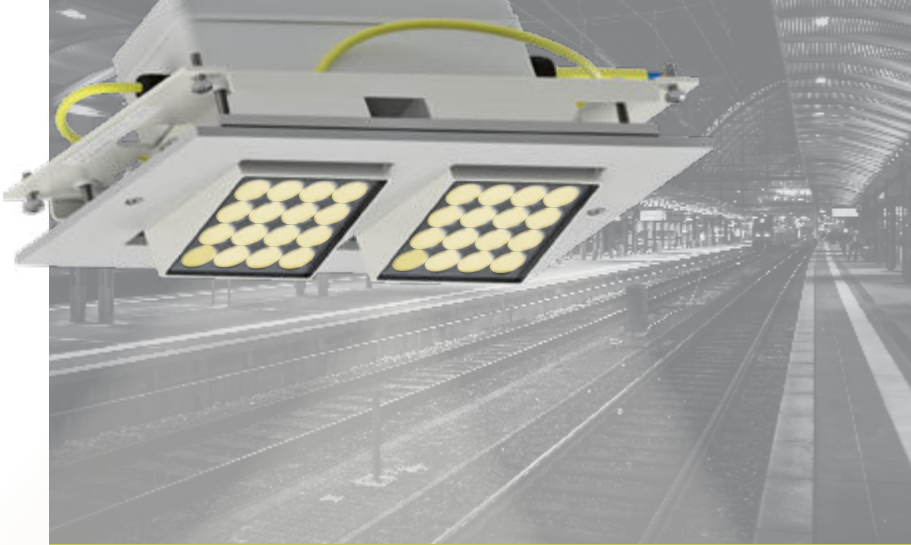

2000 lm | CRI > 85 | 4000 K

Optimale Beleuchtung für das "Bahnsteigdach Hamburg"

Optimal lighting for the "Hamburg platform roof"

Unsere DB-Dachbeleuchtung ist eine projektspezifische Leuchte, die speziell für die Montage in das Bahnsteigdach (Modell-Typ Hamburg) am Hauptbahnhof Frankfurt entwickelt wurde.

Die Leuchte ist so konstruiert, dass sie in die vorhandenen Ausschnitte im „Bahnsteigdach Hamburg“ einfach montiert werden kann. Um die Neigung nach der Montage individuell auf bauseitige Gegebenheiten einzustellen, ist zudem der Neigungswinkel um bis zu +/-15° aus der Achse einstellbar.

Die Leuchte wird vor Auslieferung mind. 24h auf ihre Funktionsfähigkeit getestet. Sie wird anschlussfertig, mit einem 2m langen Anschlusskabel, vom Typ Ölflex 540P 2x0,75mm², mit offenem Kabelende geliefert.

Our DB roof lighting is a projectspecific luminaire that was specially developed for installation in the platform roof (Hamburg model type) at Frankfurt Central Station. The luminaire is designed so that it can be easily mounted in the existing cut-outs in the "Hamburg platform roof". In order to adjust the tilt individually to the conditions on site after installation, the tilt angle can also be adjusted by up to +/-15° to the axis. The luminaire is tested for functionality for at least 24 hours before delivery. It is supplied ready for connection, with a 2m long connection cable, type Ölflex 540P 2x0.75mm², with open cable end.



zwei integrierte, bewegliche Solaris Strahler

two integrated, movable Solaris spotlights



characteristics



dimming



mounting



Technische Daten
technical data

Abmessungen dimensions	342 x 196 x 140 mm (L x T x H) *
Gewicht weight	5 kg
Farbort colour location	4000 K
Farbwiedergabeindex CRI	> 85
Lumenstrom luminous flux	2000 lm
Austrahlungswinkel FWHM* beam angle FWHM	C0/C180: 45,6° Halbstreuwinkel half-peakdivergence C90-C270: 56,4° Halbstreuwinkel half-peakdivergence
Interner Betriebsstrom EVG internal operating current	650 mA
Bestromung LED power supply LED	162,5 mA (Samsung)
Anzahl LED-Gruppen number of LED groups	4
Überspannungsschutz surge protection	ja, Typ Dehn DCOR L 1P 275 (900 431)
	5 kA
Max. Ableitstoßstrom (8/20 µs) (Imax) max. Leakage current	10 kA
Schutzpegel [L-N] (UP) protection level	≤ 1,5 kV
Schutzpegel [L-N] bei 3 kA (UP) protection level	≤ 1 kV
Schutzpegel [L-N] bei 1,5 kA (UP) protection level	≤ 0,85 kV
Ansprechzeit [L-N] (tA) response time	≤ 25 ns
Anzahl Lichtköpfe number of light heads	2
Unabhängige Lichtköpfe independent light heads	ja
Betriebsgerät operating unit	2x SLT35-1000IB(L)-UN
Versorgungsspannung supply voltage	230 V AC
Frequenz frequency	50-60 HZ
Einschaltstrom inrush current	2x20 A = 40 A
Leistung/Effizienz power/efficiency	2x9,5 W (50Hz) / > 106 lm/W
Gesamtleistung total output	19 W
Schutzklasse protection class	II
Schutzart protection type	IP 65
Stoßfestigkeit Impact resistance	IK08

* Die angegebenen Maße können auch individuell angepasst werden.
The specified dimensions can also be customised.

Lichtverteilungskurven
light distribution curves

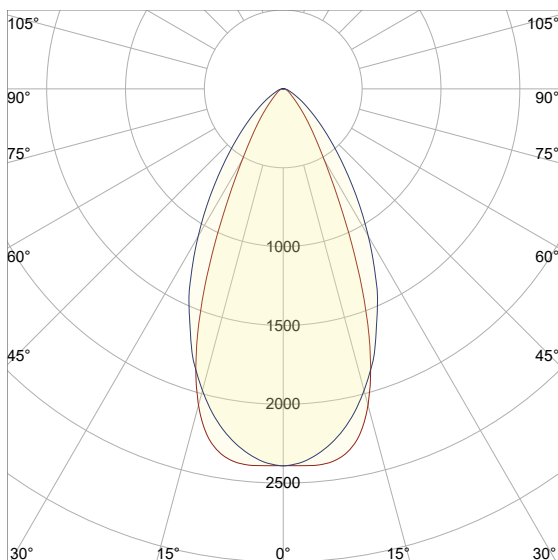

* Full Width at Half Maximum / Halbwertsbreite

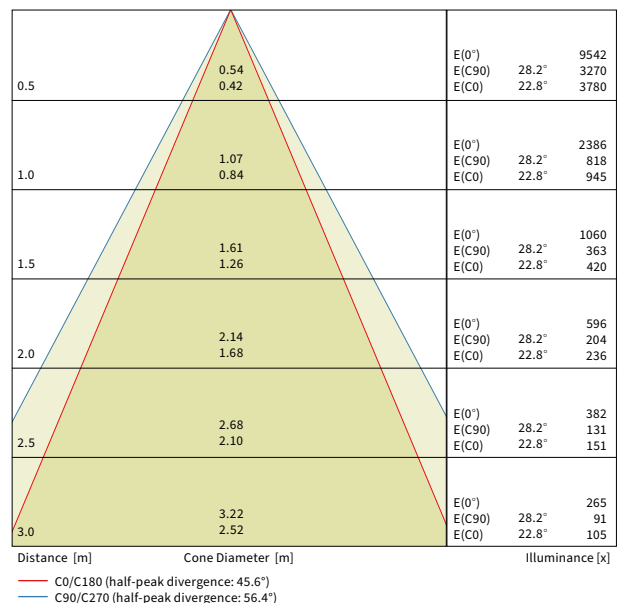

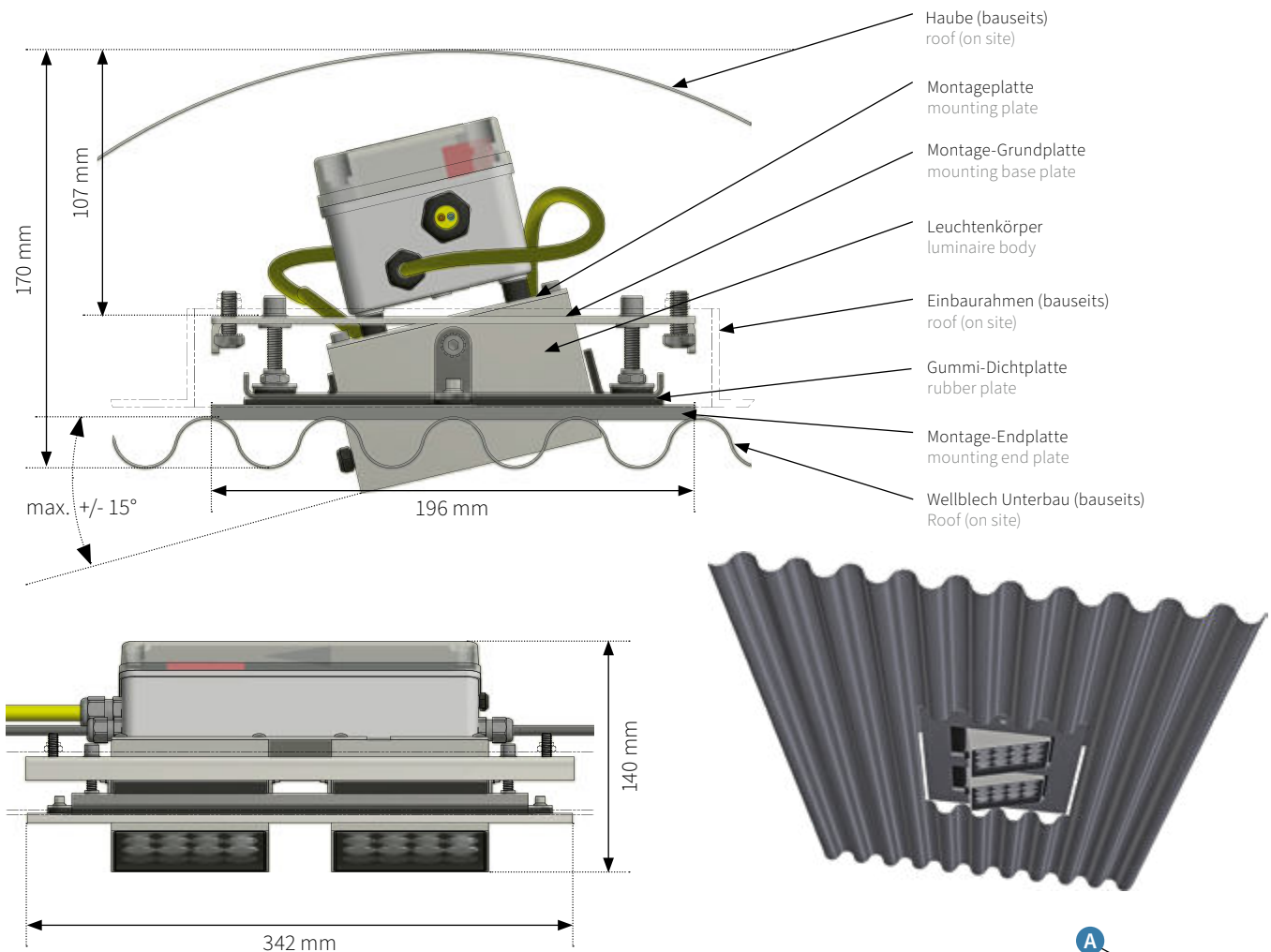

! Die angegebenen Maße können auch individuell angepasst werden.
The specified dimensions can also be customised.

- A** Die Leuchte anschließen. (siehe Stromlaufplan im Datenblatt)
Connect the luminaire. (see wiring diagram in the data sheet)
- B** Die Montage-Grundplatte im Winkelrahmen verschrauben.
Screw the mounting base plate into the angle frame.
- C** Den Leuchtenkörper einsetzen und mit der Montage-Grundplatte verschrauben.
Insert the lamp body and screw it to the mounting base plate.
- D** Händisch den gewünschten Neigungswinkel von 0 bis +/- 15° festlegen.
Manually set the desired angle of inclination from 0 to +/- 15°.
- E** Feststellschraube festziehen
Tighten the set screw
- F** Gummi-Dichtplatte einsetzen (einfädeln)
Insert (thread) rubber sealing plate
- G** Montage-Endplatte anschrauben
Screw on the mounting end plate

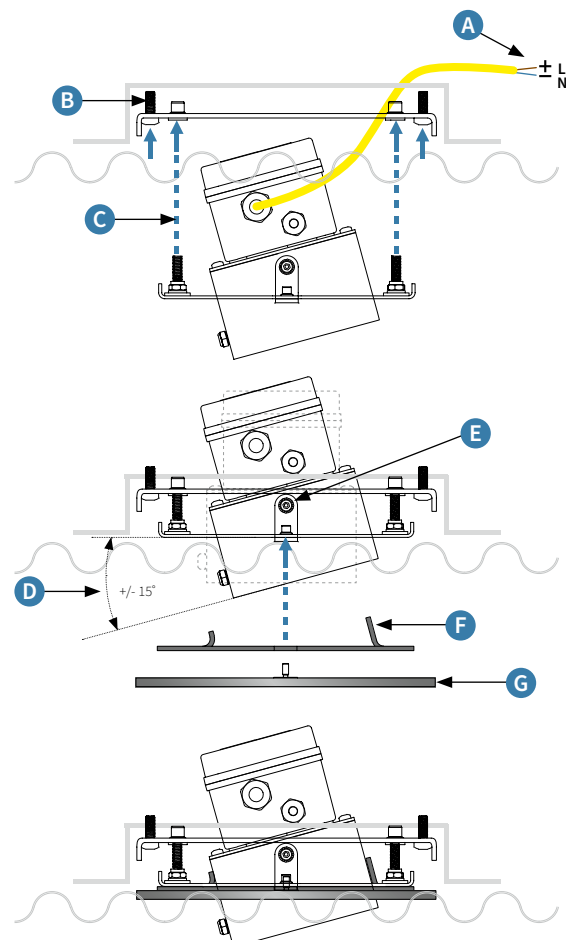





Schlosskeller im Berliner Schloss

Ein unterleuchteter Steg führt die Besucher durch die Ausstellung im einzig erhaltenen Bereich des Berliner Schlosses. Über 220 Meter NauticProfil® Leuchten wurden unterhalb des Steges montiert und heben diesen vom dunklen Untergrund ab. Das schafft Orientierung und Sicherheit und sorgt zugleich für einen schwebenden Effekt.

Palace cellar in the Berlin Palace

An underlit walkway leads visitors through the exhibition in the only preserved area of the Berlin Palace. More than 220 metres of NauticProfil® luminaires were installed underneath the jetty, making it stand out from the dark background. This creates orientation and safety while providing a floating effect.



Technisches Equipment
technical equipment



© Brücke am Kesselberg, Mainz / Christian Hattmer

Technisches Equipment technical equipment

Die FLASHAAR® LED-Leuchten und Beleuchtungssysteme sind mit sämtlichen Steuerungssystemen kompatibel – von 1...10 V über Potentiometer, DALI und DMX bis hin zu ZigBee, KNX und Casambi. Informationen zur Steuerung von Leuchten über Casambi finden Sie ab Seite 260.

Die passenden Konverter und Dimmer für die optimale Ansteuerung Ihrer LED-Lösungen erhalten Sie bei FLASHAAR® aus einer Hand und damit garantiert aufeinander abgestimmt. Je nach Anwendung stehen Geräte mit Konstantspannungs-Ausgängen von 24V und 48V oder mit Konstantstrom-Ausgängen von 350mA bis 700mA zur Auswahl.

Alle FLASHAAR® Betriebsgeräte zeichnen sich durch ihr thermisch stabiles Verhalten aus, das einen effizienten Betrieb und eine lange Lebensdauer unserer LED-Module gewährleistet.

FLASHAAR® LED luminaires and lighting systems are compatible with all control systems – from 1...10 V with potentiometer, DALI and DMX to ZigBee, KNX and Casambi controls. Please refer to the information page 260 following for details about using luminaires with Casambi controllers.

FLASHAAR® is your single source for perfectly coordinated converters and dimmers used to control your LED solutions in the best possible way. Equipment with constant voltage outputs of 24V and 48V or with constant current outputs ranging from between 350mA and 700mA are available depending on the application.

All FLASHAAR® devices are characterised by their stable thermal behaviour so our LED modules are guaranteed to deliver long-lasting and efficient operation.

Konverter Konstantspannung

power supply units constant voltage

24V

item nr.: HLG-240H-24A

L x B x H: 244,2 x 68 x 38,8mm
efficiency: 92,5%

manufacturer:
MEAN WELL



INPUT

VAC	Hz	VDC	inrush current
90-305	47-63	127-431	75 A at 230 VAC

OUTPUT

VDC	Vout	I[A]	P[W]
24	22,4-25,6	10	240

item nr.: UPT/BLD-240-24

L x B x H: 216 x 67,5 x 38,5mm
efficiency: 90%

manufacturer:
uPowerTek



VAC	Hz	VDC	inrush current
90-305	47-63	127-420	65 A at 230 VAC

VDC	Vout	I[A]	P[W]
24	10	240

item nr.: HLG-320H-24A

L x B x H: 252 x 90 x 43,8mm
efficiency: 94%

manufacturer:
MEAN WELL



VAC	Hz	VDC	inrush current
90-305	47-63	127-431	70 A at 230 VAC

VDC	Vout	I[A]	P[W]
24	21-26	13,34	320,16

item nr.: UPT/BLD-320-24

L x B x H: 224 x 90 x 41,5 mm
efficiency: 90%

manufacturer:
uPowerTek



VAC	Hz	VDC	inrush current
90-305	47-63	127-420	65 A at 230 VAC

VDC	Vout	I[A]	P[W]
24	13,3	320

item nr.: HLG-480H-24A

L x B x H: 262 x 125 x 43,8 mm
efficiency: 94%

manufacturer:
MEAN WELL



VAC	Hz	VDC	inrush current
90-305	47-63	127-431	35 A at 230 VAC

VDC	Vout	I[A]	P[W]
24	20,4-25,2	20	480

item nr.: UPT/BLD-480-24

L x B x H: 224 x 90 x 41,5 mm
efficiency: 90%

manufacturer:
uPowerTek



VAC	Hz	VDC	inrush current
90-305	47-63	127-420	65 A at 230 VAC

VDC	Vout	I[A]	P[W]
24	20	480

item nr.: HLG-600H-24A

L x B x H: 280 x 144 x 48,5 mm
efficiency: 95%

manufacturer:
MEAN WELL



VAC	Hz	VDC	inrush current
90-305	47-63	127-431	70 A at 230 VAC

VDC	Vout	I[A]	P[W]
24	20,4-25,2	25	600

48V

item nr.: HLG-240H-48A

L x B x H: 244,2 x 68 x 38,8mm
efficiency: 93%

manufacturer:
MEAN WELL



INPUT

VAC	Hz	VDC	inrush current
90-305	47-63	127-431	75 A at 230 VAC

OUTPUT

VDC	Vout	I[A]	P[W]
48	44,8-51,2	5	240

item nr.: BLD-240-V048

L x B x H: 216 x 67,5 x 38,5mm
efficiency: 90%

manufacturer:
uPowerTek



VAC	Hz	VDC	inrush current
90-305	47-63	127-420	65 A at 230 VAC

VDC	Vout	I[A]	P[W]
48	5

item nr.: HLG-320H-48A

L x B x H: 252 x 90 x 43,8mm
efficiency: 95%

manufacturer:
MEAN WELL



VAC	Hz	VDC	inrush current
90-305	47-63	127-431	75 A at 230 VAC

VDC	Vout	I[A]	P[W]
48	43-52	6,7	321,6

item nr.: UPT/BLD-320-48

L x B x H: 224 x 90 x 41,5mm
efficiency: 90%

manufacturer:
uPowerTek



VAC	Hz	VDC	inrush current
90-305	47-63	127-420	65 A at 230 VAC

VDC	Vout	I[A]	P[W]
48	6,7	320

item nr.: HLG-480H-48A

L x B x H: 262 x 125 x 43,8mm
efficiency: 94%

manufacturer:
MEAN WELL



VAC	Hz	VDC	inrush current
90-305	47-63	127-431	35 A at 230 VAC

VDC	Vout	I[A]	P[W]
48	40,8-50,4	10	480

item nr.: BLD-400-V048

L x B x H: 224 x 90 x 41,5mm
efficiency: 90%

manufacturer:
uPowerTek



VAC	Hz	VDC	inrush current
90-305	47-63	127-420	65 A at 230 VAC

VDC	Vout	I[A]	P[W]
48	10	480

item nr.: HLG-600H-48A

L x B x H: 280 x 144 x 48,5mm
efficiency: 96%

manufacturer:
MEAN WELL





























VAC	Hz	VDC	inrush current
90-305	47-63	127-431	70 A at 230 VAC

VDC	Vout	I[A]	P[W]
48	40,8-50,4	12,5	600

Verbindliche technische Daten finden Sie im Datenblatt des jeweiligen Herstellers.
The relevant technical data can be found on the data sheet of the respective manufacturer.



Dimmer Konstantspannung

dimmer constant voltage

		INPUT			OUTPUT						
LINEARdrive DC Full-Colour Dimmable LED Driver	item nr.: LIN720D3				V [DC] 12-48	Vout 48	V [DC] 5-48	CH 4	I[A] 4x6	P[W] 720	PWM dimming ... Hz
DALI DT6 witchDim, 1-10V DIMMbox CV	item nr.: DIMMbox-CV				V [DC] 15-50	Vout 48	V [DC] 15-50	CH 1	I[A] 1x5	P[W] 240	PWM dimming 600 Hz
DALI DT6 1CH LED DALI Dimmer 16A Luna	item nr.: 89453829				V [DC] 12-48	Vout 48	V [DC] 12-48	CH 1	I[A] 16**	P[W] 768**	PWM dimming max. 976 Hz
** max. 16 A auf 1CH verteilbar / PWM-Frequenz softwareseitig einstellbar siehe Hersteller-Datenblatt ** maximum 16 A distributable to 1 CH / PWM frequency adjustable by software see manufacturer data sheet											
DALI DT6 2CH LED DALI Dimmer 16A Luna	item nr.: 89453830				V [DC] 12-48	Vout 48	V [DC] 12-48	CH 2	I[A] 16**	P[W] 768**	PWM dimming max. 976 Hz
** max. 16 A auf 2CH verteilbar / PWM-Frequenz softwareseitig einstellbar siehe Hersteller-Datenblatt ** maximum 16 A distributable to 2 CH / PWM frequency adjustable by software see manufacturer data sheet											
DALI DT6 3CH LED DALI Dimmer 16A Luna	item nr.: 89453831				V [DC] 12-48	Vout 48	V [DC] 12-48	CH 3	I[A] 16**	P[W] 768**	PWM dimming max. 976 Hz
** max. 16 A auf 3CH verteilbar / PWM-Frequenz softwareseitig einstellbar siehe Hersteller-Datenblatt ** maximum 16 A distributable to 3 CH / PWM frequency adjustable by software see manufacturer data sheet											
DALI DT6 4CH LED DALI Dimmer 16A Luna	item nr.: 89453832				V [DC] 12-48	Vout 48	V [DC] 12-48	CH 4	I[A] 16**	P[W] 768**	PWM dimming max. 976 Hz
** max. 16 A auf 4CH verteilbar / PWM-Frequenz softwareseitig einstellbar siehe Hersteller-Datenblatt ** maximum 16 A distributable to 4 CH / PWM frequency adjustable by software see manufacturer data sheet											
DALI DT8 CW-WW DALI PWM 16A	item nr.: 89453841				V [DC] 12-48	Vout 48	V [DC] 12-48	CH 2	I[A] 2x8	P[W] 2x384	PWM dimming max. 976 Hz
PWM-Frequenz softwareseitig einstellbar siehe Hersteller-Datenblatt PWM frequency adjustable by software see manufacturer data sheet											
DALI DT8 3CH RGB-DALI PWM 16A	item nr.: 89453828				V [DC] 12-48	Vout 48	V [DC] 12-48	CH 3	I[A] 3x5,33	P[W] 3x256	PWM dimming max. 976 Hz
PWM-Frequenz softwareseitig einstellbar siehe Hersteller-Datenblatt PWM frequency adjustable by software see manufacturer data sheet											
DALI DT8 4CH RGBW-DALI PWM 16A	item nr.: 89453843				V [DC] 12-48	Vout 48	V [DC] 12-48	CH 4	I[A] 4x4	P[W] 4x192	PWM dimming max. 976 Hz
PWM-Frequenz softwareseitig einstellbar siehe Hersteller-Datenblatt PWM frequency adjustable by software see manufacturer data sheet											

Signalwandler Konstantspannung

signal converter constant voltage

		INPUT			OUTPUT						
DALI DT6 PWM Interface LED Dimmer 100 mA	item nr.: 86458508-100				V [DC] 12-48	Vout 48	V [DC] 3-45	CH 1	I[A] 0,1	P[W] 4,8	PWM dimming max. 976 Hz
PWM-Frequenz softwareseitig einstellbar siehe Hersteller-Datenblatt PWM frequency adjustable by software see manufacturer data sheet											

Verbindliche technische Daten finden Sie im Datenblatt des jeweiligen Herstellers. **Der maximale Anschlussstrom kann beliebig auf die Kanäle verteilt werden.
The relevant technical data can be found on the data sheet of the respective manufacturer. **The maximum input current can be distributed on the channels at will.

Dimmer Konstantstrom

dimmer constant current

DALI DT6 4CH LED Dimmer CC 250/350/500/700 mA

L x B x H: 120 x 41 x 20mm
Control Protocol: DALI DT6
efficiency: Lunatone

item nr.:
89453855-250

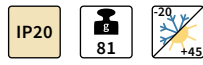

INPUT

V [DC]
12-48

OUTPUT

V _{out}	V [DC]	CH	I [A]	P [W]	PWM
48	3-45	4	4x0,25	4x12	dimming max. 976 Hz

item nr.:
89453855-350

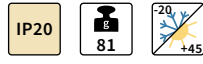

V [DC]
12-48

V _{out}	V [DC]	CH	I [A]	P [W]	PWM
48	3-45	4	4x0,35	4x16,8	dimming max. 976 Hz

item nr.:
89453855-500

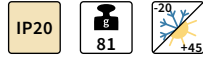

V [DC]
12-48

V _{out}	V [DC]	CH	I [A]	P [W]	PWM
48	3-45	4	4x0,5	4x24	dimming max. 976 Hz

item nr.:
89453855-700

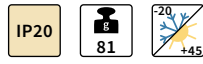

V [DC]
12-48

V _{out}	V [DC]	CH	I [A]	P [W]	PWM
48	3-45	4	4x0,7	4x33,6	dimming max. 976 Hz

PWM-Frequenz softwareseitig einstellbar siehe Hersteller-Datenblatt
 PWM frequency adjustable by software see manufacturer data sheet

DALI DT8 4CH LED Dimmer CC 250/350/500/700 mA

L x B x H: 120 x 41 x 20mm
Control Protocol: DALI DT8
manufacturer: Lunatone

item nr.:
86458912-250

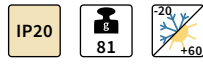

V [DC]
12-48

V _{out}	V [DC]	CH	I [A]	P [W]	PWM
48	3-45	4	max. 0,25	max.12	dimming max. 976 Hz

item nr.:
86458912-350

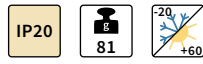

V [DC]
12-48

V _{out}	V [DC]	CH	I [A]	P [W]	PWM
48	3-45	4	max. 0,35	max.16,8	dimming max. 976 Hz

item nr.:
86458912-500

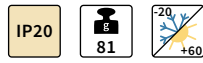

V [DC]
12-48

V _{out}	V [DC]	CH	I [A]	P [W]	PWM
48	3-45	4	max. 0,5	max.24	dimming max. 976 Hz

item nr.:
86458912-700



V [DC]
12-48

V _{out}	V [DC]	CH	I [A]	P [W]	PWM
48	3-45	4	max. 0,7	max.33,6	dimming max. 976 Hz

PWM-Frequenz softwareseitig einstellbar siehe Hersteller-Datenblatt
 PWM frequency adjustable by software see manufacturer data sheet

DALI DT6 1CH LED Dimmer CC350 mA

L x B x H: 59 x 33 x 15mm
Control Protocol: DALI DT6
manufacturer: Lunatone

item nr.:
89453844-350



V [DC]
12-48

V _{out}	V [DC]	CH	I [A]	P [W]	PWM
48	3-45	1	0,35	16,8	dimming max. 976 Hz

PWM-Frequenz softwareseitig einstellbar siehe Hersteller-Datenblatt
 PWM frequency adjustable by software see manufacturer data sheet

DALI DT6 1CH LED Dimmer CC500 mA

L x B x H: 59 x 33 x 15mm
Control Protocol: DALI DT6
manufacturer: Lunatone

item nr.:
89453844-500



V [DC]
12-48

V _{out}	V [DC]	CH	I [A]	P [W]	PWM
48	3-45	1	0,5	24	dimming max. 976 Hz

PWM-Frequenz softwareseitig einstellbar siehe Hersteller-Datenblatt
 PWM frequency adjustable by software see manufacturer data sheet

DALI DT6 1CH LED Dimmer CC700 mA

L x B x H: 59 x 33 x 15mm
control protocol: DALI DT6
manufacturer: Lunatone

item nr.:
89453844-700



V [DC]
12-48

V _{out}	V [DC]	CH	I [A]	P [W]	PWM
48	3-45	1	0,7	33,6	dimming max. 976 Hz

PWM-Frequenz softwareseitig einstellbar siehe Hersteller-Datenblatt
 PWM frequency adjustable by software see manufacturer data sheet

Netzteil Konstantstrom

power supply constant current

DALI DT6 PWM Interface LED Dimmer 100 mA

L x B x H: 120 x 41 x 22mm
Control Protocol: DALI DT6
manufacturer: Lunatone

Item Nr.:
89453849-700

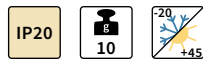

INPUT

V [DC]
220-240

OUTPUT

V _{out}	V [DC]	CH	I [A]	P [W]	PWM
32	12-32	2	700	23	dimming max. 976 Hz

PWM-Frequenz softwareseitig einstellbar siehe Hersteller-Datenblatt
 PWM frequency adjustable by software see manufacturer data sheet

Verbindliche technische Daten finden Sie im Datenblatt des jeweiligen Herstellers.
 The relevant technical data can be found on the data sheet of the respective manufacturer.

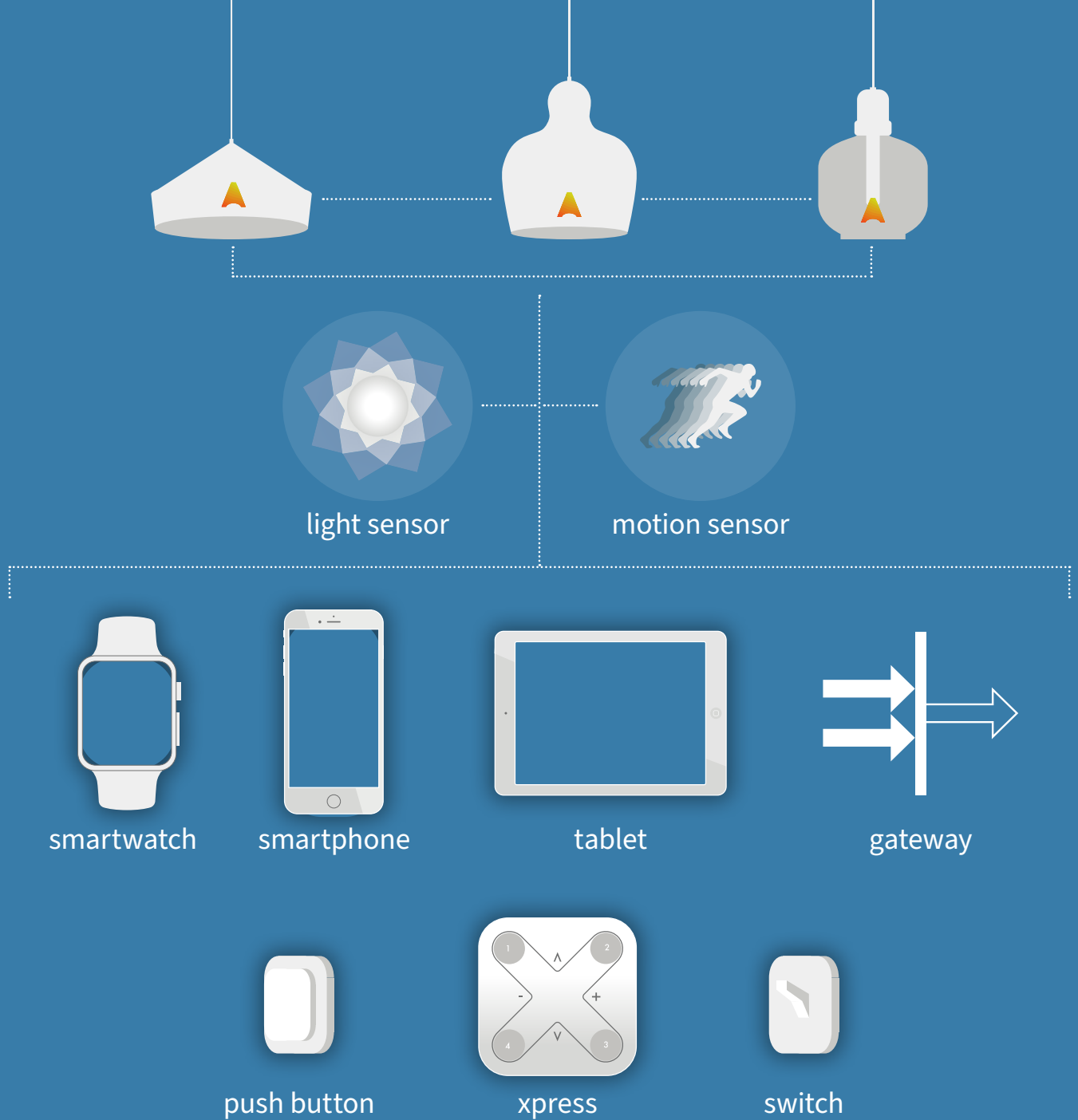

Smarter Lichtschalter

Der Xpress ist ein drahtloser Lichtschalter und eine Fernbedienung zugleich. Der Xpress bringt hohe Flexibilität in die Innenarchitektur, da Möbel frei umgestellt oder Wände neu gebaut werden können ohne die Verkabelung für Lichtschalter oder deren Platzierung berücksichtigen zu müssen. Der Schalter kann angebracht werden wo immer der Nutzer ihn benötigt und er ermöglicht direkten Zugriff auf alle wichtigen Funktionen der Casambi Lichtsteuerung.

smart light switch

Xpress is a wireless user interface that brings huge flexibility to interior design as furniture can be replaced or even walls can be rebuilt without having to take wiring of switches or switch placement into account. The switch can be kept wherever the user needs it and it gives direct access to all the important Casambi lighting control functionalities.





Lichtsteuerung per App lightcontrolling via app

FLASHAAR® Leuchten lassen sich ganz einfach per Smartphone, Tablet oder Smartwatch steuern.

Dazu setzen wir auf Casambi Module und die zugehörige App für iOS und Android. Mit der Lösung lassen sich Leuchten ohne komplizierte Verkabelung und Installation schalten und dimmen.

Sie können zu Schaltgruppen zusammengefasst, per Timer oder Sensoren gesteuert und für individuelle Lichtszenen programmiert werden. Bei FLASHAAR® RGB- und RGBW-Leuchten wird neben der Helligkeit auch die Lichtfarbe einfach per App reguliert.

So garantiert Casambi im Zusammenspiel mit FLASHAAR® Beleuchtungssystemen stimmungsvolles Licht für jedes Ambiente.

Casambi ist eine fortschrittliche Lichtsteuerungslösung,

die auf Bluetooth Low Energy (BLE) basiert. BLE ist eine drahtlose Technologie auf dem neuesten Stand der Technik und die einzige drahtlose Technologie mit geringem Stromverbrauch in allen modernen Smartphones, Tablets und sogar Smartwatches. Damit ist BLE die einzige gängige und zukunftssichere Funktechnologie mit geringem Stromverbrauch in der Welt.

Die Casambi-Technologie kann in Leuchten, LED-Treibern und sogar in LED-Modulen oder -Lampen integriert werden, wodurch eine optimale Lösung in Bezug auf einfache Installation und Funktionalität mit minimalen zusätzlichen Hardware- und Bereitstellungskosten geschaffen wird.

Smartphones, tablet PCs and even smartwatches may be used to easily control FLASHAAR® luminaires.

We employ Casambi modules and the corresponding iOS and Android apps to do so. This combination makes it possible to control luminaires without the need for complicated cabling and installation.

It's possible to combine them into switching groups, control them with timers and sensors and program them for individual lighting scenes. Both brightness and the colour of FLASHAAR's RGB and RGBW luminaires may be easily controlled by an app.

This means that atmospheric lighting for any ambience may be created with Casambi controls used in conjunction with FLASHAAR® lighting systems.

casambi is an advanced lighting control solution

based on Bluetooth Low Energy (BLE). BLE is a state-of-the-art wireless technology and the only low power wireless technology in all modern smartphones, tablets and even smart watches, making it the only mainstream and future proof low power radio technology in the world.

Casambi technology can be integrated into luminaires, LED-drivers and even within LED-modules or bulbs, creating an optimal solution in terms of ease of installation and functionality with minimal additional hardware and deployment costs.



Kabellose Steuereinheit für Dali und 1-10 V LED-Treiber

CBU-ASD

input	
Voltage range	220-240 VAC
Frequency	50 Hz
Max. mains current	0,6 A
mains output	
Output relay	SSR on phase line
Voltage range	220-240 VAC
Frequency	50 Hz
0-10V output	
Voltage range	0-10 VDC
Maximum number of drivers connected	1 pc
DALI output	
Voltage range	9-12 VDC
Maximum number of drivers connected	1 pc
radio transceiver	
Operating frequencies	2,4...2,483 Ghz
Maximum output power	+4 dBm
operating conditions	
Ambient temp., ta:	-20...+50°C (Iout 0 A) -20...+40°C (Iout 0,6 A)
Max. case temp., tc	+70 °C
Storage temp.	-25...+75 °C
Max. relative humidity	0...80%, non-cond.
connectors	
Wire range, solid & stranded	0,75-1,5 mm2 14-22 AWG
Wire strip length	6-7 mm
Tightening torque	0,4 Nm / 4 Kgf.cm / 2,6 Lb-In
mechanical data	
Dimensions	56,5 x 35,8 x 22,3 mm
Weight	48g
Degree of protection	IP20 (indoor use only)
Protection class	Built-in Class II



Vierkanal-PWM-Dimmer für Konstantspannungs-Anwendungen

CBU-PWM4

input	
Voltage range	12-24VDC
Max. input current	6A
No-load standby power	< 0,3W
output	
Output voltage	same as input voltage
Max. output power	144W @ 24VDC 72W @ 12VDC
Max. output current	6A (can be freely divided between the channels)
Min. load requirement	0W
Dimming method	Pulse Width Modulation (PWM)
radio transceiver	
Operating frequencies	2,4...2,483 Ghz
Maximum output power	+4 dBm
operating conditions	
Ambient temp., ta	-20...+45°C
Max. case temp., tc	+75°C
Storage temp.	-25...+75°C
Max. relative humidity	0...80%, non-cond.
connectors	
Wire range, solid & stranded	0,75 - 1,5 mm2 14 - 22 AWG
Wire strip length	6 - 7 mm
Tightening force	0,4 Nm
Maximum input cable length	3m
mechanical data	
Dimensions	72,6 x 30,0 x 18,0 mm
Weight	23g
Degree of protection	IP20 (indoor use only)



Bluetooth Controller Dali Controller ohne Busversorgung

CBU-DCS

input	
Voltage range	9,5-22,5VDC
Input current when idle, Iidle	5 mA
Peak input current, Ipeak	30 mA
Max. DALI bus current	250 mA
Standby power	< 0,1 W
radio transceiver	
Operating frequencies	2,4...2,483 Ghz
Maximum output power	+4 dBm
operating conditions	
Ambient temp., ta	-20...+55°C
Max. case temp., tc	+65°C
Storage temp.	-25...+75°C
Max. relative humidity	0...80%, non-cond.
connectors	
Wire range, solid & stranded	0,5 - 1,5 mm2 16 - 20 AWG
Wire strip length	6 - 8 mm
mechanical data	
Dimensions	40,4 x 36,3 x 14,0 mm
Weight	15g
Degree of protection	IP20 (indoor use only)
insulation	
Casing to DALI	Reinforced

Intelligentes Lichtmanagement intelligent light management

Benutzerfreundlich

Das System kann von jedermann verwendet und modifiziert werden, es sind keine Experten für die Inbetriebnahme nötig.

Drahtlos

Das Casambi-Netzwerk basiert auf dem Bluetooth Low Energy-Protokoll.

Keine Gateways

BLE wurde für das Internet der Dinge (IoT) entwickelt und ist seit Anfang 2012 in allen modernen Smartphones, Tablets und sogar Smartwatches implementiert.

App

Für den Zugriff auf alle Funktionen der Casambi-Netzwerke wird eine App benötigt. Die App kann kostenlos im Apple App Store oder im Google Play Store unter dem Namen Casambi heruntergeladen werden. Die App ist intuitiv und selbsterklärend.

Casambi-Funktionalitäten

Mit Casambi kann die Beleuchtung über Smartphones, Tablets, Smartwatches, Drucktasten, Schalter oder den kabellosen Schalter Xpress von Casambi gesteuert werden. Eine intelligente Steuerung kann sogar mit alten Wandschaltern erreicht werden.

Mit Casambi können Sie folgende Dinge tun:

- Ihre Leuchten ein- und ausschalten
- Die Beleuchtung dimmen
- Gruppieren Sie Leuchten und schalten Sie sie ein, aus und dimmen Sie sie als Gruppe
- Szenen konfigurieren, speichern und aufrufen
- Animationen konfigurieren, speichern und abrufen
- Überblendzeitpassungen für Szenen und Animationen vornehmen
- Verwenden Sie den Timer, um Szenen oder Animationen basierend auf Uhrzeit und Datum ein- und auszuschalten
- Passen Sie die Farben und Farbtemperaturen an
- Verwenden Sie Bewegungssensoren
- Bluetooth-Signalstärke für die Standortbestimmung
- Nehmen Sie Bilder aus Ihren Räumen auf oder laden Sie Ihre Lichtplanzeichnungen hoch und fügen Sie die Lichtsteuerung direkt auf Ihrem Bild ein
- Berücksichtigen Sie Sonnenaufgang und Sonnenuntergang, wenn Sie Timer definieren
- Statusinformationen vom System abrufen
- Aktualisieren Sie die Firmware drahtlos
- Systemfunktionalitätsaktualisierungen über Funk
- Inbetriebnahmeunterstützung innerhalb der App

user friendly

The system can be used and modified by anyone, no commissioning experts are needed.

wireless

The Casambi network is based on the Bluetooth Low Energy protocol.

no gateways

BLE was built for Internet of Things (IoT) and has been implemented in all modern smartphones, tablets and even smart watches since the beginning of 2012.

app

To access all the functionality of the Casambi networks an app is needed. The app can be downloaded for free from Apple App Store or Google Play Store with the name Casambi. The app is intuitive and self explanatory.

casambi functionalities

With Casambi, lighting can be controlled via smartphones, tablets, smart watches, push buttons, switches or Casambi's wireless switch called Xpress. Smart control can even be achieved from old wall switches.

with casambi you can:

- Turn on and off your luminaires
- Dim the lighting
- Group luminaires and turn on, off and dim the group as one
- Configure, save and recall scenes
- Configure, save and recall animations
- Adjust fade times for scenes and animations
- Use the timer to turn on and off scenes or animations based on time and date
- Adjust colours
- Adjust colour temperatures
- Use motion sensors
- Bluetooth signal strength for geo locationing
- Take pictures from your spaces or upload your lighting layout drawings and add lighting control directly to your picture
- Take sunrise and sunset into account while defining timers
- Get status information from the system
- Update the firmware over-the-air
- System functionality updates over-the-air
- Commissioning support within the app

Allgemeine Geschäftsbedingungen

§1 Geltungsbereich und Abwehrklausel

- (1) Nachstehende Allgemeine Geschäftsbedingungen gelten für alle Verträge über Lieferungen von Waren und Erbringung von Leistungen durch uns und sämtliche damit zusammenhängenden Rechtsbeziehungen.
- (2) Abweichende, entgegenstehende oder ergänzende Allgemeine Geschäftsbedingungen werden, selbst bei Kenntnis, nicht Vertragsbestandteil.
- (3) Gegenüber Unternehmern gelten nachstehende Allgemeine Lieferungs- und Leistungsbedingungen auch für alle zukünftigen Verträge.

§2 Angebot und Leistung, Unverbindlichkeit von Angaben

- (1) Unsere Veröffentlichungen über Waren und Leistungen stellen kein verbindliches Angebot dar.
- (2) Die Bestellung des Kunden ist ein verbindliches Angebot, an das er zwei Wochen gebunden ist. Wir sind berechtigt, dieses Angebot durch Zusendung einer Auftragsbestätigung, aber auch durch Lieferung der bestellten Ware bzw. Erbringung der bestellten Leistung anzunehmen.
- (3) Alle zum Angebot gemachten Angaben über Farben, Maße und technische Kenngrößen sind im Zweifel unverbindlich. Auch der Inhalt von Konstruktionszeichnungen, Abbildungen und Datenblättern stellt im Zweifel keine vertraglich vereinbarte Beschaffenheit dar. Enthält unser Angebot eine Aufstellung bestimmter Leistungen, so erstreckt sich unsere Leistungspflicht im Zweifel nur auf diese in der Aufstellung enthaltenen Leistungen.
- (4) Alle von uns genannten Preise verstehen sich im Zweifel in der Währung Euro und ohne Mehrwertsteuer. Im Zweifel gelten unsere zum Zeitpunkt des Vertragschlusses zugänglichen Preislisten und Stundensätze. Anfahrt und Rückfahrt werden gesondert berechnet.
- (5) An allen von uns für den Kunden erstellten Zeichnungen, Plänen und Kalkulationsunterlagen behalten wir uns alle Rechte vor. Sie sind vertraulich zu behandeln und dürfen ohne unsere Zustimmung nicht an Dritte weitergegeben, öffentlich zugänglich gemacht oder veröffentlicht werden. Sofern wir Zeichnungen und Pläne im Hinblick auf einen noch nicht erteilten Auftrag des Kunden erstellen, erhält der Kunde die von uns erstellten Zeichnungen und Pläne zur weiteren Verwertung nur dann, wenn er uns dafür eine Vergütung von 5% der Bruttoangebotssumme zahlt.

§3 Unverbindlichkeit von Fristen und Terminen, Teilleistungen

- (1) Von uns angegebene Fristen und Termine für Lieferungen und Leistungen sind im Zweifel unverbindlich und freibleibend.
- (2) Wir sind zu Teillieferungen und Teilleistungen berechtigt.

§4 Mitwirkungshandlungen des Kunden

- (1) Der Kunde ist verpflichtet, dafür Sorge zu tragen, dass durch seine Vorgaben für unsere Arbeiten und den Inhalt seines Auftrags Rechtsnormen und behördliche Vorgaben, insbesondere die des Baurechts und private Rechte Dritter nicht verletzt werden und die erforderlichen behördlichen Genehmigungen und Zustimmung Dritter vor Ausführung unserer Arbeiten vorliegen.
- (2) Der Kunde ist verpflichtet, für den ungehinderten Zugang zur Baustelle während der Ausführungszeit zu sorgen. Baustrom und Bauwasser sowie Gelegenheiten für die ordnungsgemäße Beseitigung von Abfällen und Abwässern hat er auf seine Kosten uns zur Verfügung zu stellen.
- (3) Der Kunde ist verpflichtet, soweit für die Erbringung unserer Leistungen erforderlich, uns Pläne und Unterlagen, insbesondere hinsichtlich der baulichen Gegebenheiten und Gebäudeverhältnisse zur Verfügung zu stellen und uns die hier erforderlichen Auskünfte, insbesondere über die Bodenverhältnisse sowie die Lage von Leitungen und Anschlüssen zu erteilen.
- (4) Der Kunde ist verpflichtet, auf unser Verlangen in angemessener Frist, Anweisungen zur Leistungsdurchführung zu erteilen, wenn seine Vorgaben lückenhaft oder fehlerhaft sind und wir ihm entsprechende Bedenken angezeigt haben.
- (5) Verstößt der Kunde schuldhaft gegen seine in Absatz 1 bis 4 genannten Verpflichtungen oder gerät er mit ihrer Erfüllung in Verzug, so hat er den uns entstehenden Schaden, einschließlich der Aufwendungen für notwendige Zwischenlagerungen und für Arbeitskosten unserer Mitarbeiter zu ersetzen. Kommt er seinen Verpflichtungen auch nach Setzung einer angemessenen Nachfrist oder einer Abmahnung durch uns schuldhaft nicht nach, sind wir zur fristlosen Kündigung des Vertrages berechtigt. Die gesetzlichen Vorschriften über den Annahmeverzug und zur Schadensersatzpflicht bleiben unberührt.

§5 Sicherheiten

- (1) Alle gelieferten Waren und Materialien bleiben bis zu deren vollständiger Bezahlung unser Eigentum. Dem Kunden ist es verwehrt, ohne unsere vorherige Zustimmung die in unserem Eigentum stehenden Sachen mit anderen Sachen zu vermischen oder zu verbinden, sie zu verarbeiten oder rechtsgeschäftlich

über sie zu verfügen. Wir verpflichten uns schon jetzt, diese Zustimmung zu erteilen, wenn der Kunde angemessene Sicherheit in Höhe des auf die jeweiligen Sachen entfallenden Preises stellt.

- (2) Führen wir Arbeiten an einer vom Kunden übergebenen beweglichen Sache durch, so wird ein rechtsgeschäftliches Pfandrecht zur Sicherung unseres Anspruchs auf Entgelt für diese Arbeiten an dieser Sache begründet.

§6 Zahlungsbedingungen, Aufrechnung, Abtretung

- (1) Die Gewährung von Zahlungszielen, Nachlässen und Skonti bedarf ausdrücklicher schriftlicher Vereinbarung.
- (2) Die Aufrechnung gegen unsere Forderungen ist nur mit unbestrittenen oder rechtskräftig festgestellten Forderungen zulässig. Der Kunde kann sein Zurückbehaltungsrecht nur ausüben, wenn und soweit sein Gegenanspruch auf demselben Vertragsverhältnis beruht.
- (3) Der Kunde darf Ansprüche und Rechte aus dem Vertragsverhältnis nur mit unserer schriftlichen Zustimmung abtreten, an Dritte – auch sicherungshalber – übertragen oder verpfänden.

§7 Gefahrübergang beim Verkauf

Beim Verkauf von Waren an Kunden, die keine Verbraucher sind, geht die Gefahr des zufälligen Untergangs und der zufälligen Verschlechterung der Ware mit Übergabe an den Kunden, bei Versendung mit Übergabe an die Transportperson, bei Lieferung auf Abruf mit Zugang der Mitteilung der Versandbereitschaft beim Kunden auf diesen über. Als Transportperson gelten auch unsere eigenen, mit Versendung und Transport beauftragten Mitarbeiter.

§8 Einschränkung von Gewährleistung und Haftung

- (1) Wir geben keine Garantien ab und sichern auch keine besonderen Eigenschaften zu. Für die finanzielle Förderung durch öffentliche oder private Mittel, die Gewährung von Einspeisevergütungen durch Versorgungsunternehmen hinsichtlich von uns errichteter, geänderter, reparierter oder instandgesetzter Anlagen, Einrichtungen und Geräte oder die Erreichung bestimmter technischer Grenzwerte lehnen wir im Zweifel jede Instandspflicht ab.
- (2) Im Übrigen richten sich die Mängelgewährleistungsrechte nach den gesetzlichen Vorschriften. Der Kunde, der Unternehmer ist, hat zusätzlich die gesetzlichen kaufmännischen Untersuchungs- und Rügeobliegenheiten zu beachten.

§9 Rechtswahl- und Gerichtsstandsklausel

- (1) Für alle Rechtsbeziehungen zwischen den Parteien nach Maßgabe von § 1 Absatz 1 gilt ausschließlich das Recht der Bundesrepublik Deutschland mit Ausnahme der internationalen Kaufgesetze.
- (2) Ist der Kunde Kaufmann, juristische Person des öffentlichen Rechts oder ein öffentlich-rechtliches Sondervermögen, so werden für alle künftigen Streitigkeiten, die sich aus den Rechtsbeziehungen zwischen den Parteien nach Maßgabe von § 1 Absatz 1 ergeben, die für 55411 Bingen örtlich zuständigen ordentlichen erstinstanzlichen Gerichte als örtlich zuständig vereinbart. Satz 1 gilt auch für jeden anderen Kunden, der, ohne Verbraucher mit Wohnsitz in der Europäischen Union zu sein, keinen allgemeinen Gerichtsstand in der Bundesrepublik Deutschland hat, nach Vertragsschluss seinen Wohnsitz, Sitz oder gewöhnlichen Aufenthaltsort aus der Bundesrepublik Deutschland verlegt oder dessen Wohnsitz, Sitz oder gewöhnlicher Aufenthaltsort zum Zeitpunkt der Klageerhebung nicht bekannt ist.

§10 Datenschutzhinweis

- (1) Name, Firmierung und Rechtsform, Anschrift des Kunden und Namen seiner Vertreter werden für die Erfüllung vertraglicher und gesetzlicher Pflichten und für die Geltendmachung vertraglicher Rechte und Ansprüche bei uns elektronisch gespeichert und verarbeitet. Bei Kunden, gegenüber denen wir in Vorleistung treten, werden bereits bei Vertragsanbahnung und während der weiteren Vertragsdurchführung Bonitätsanfragen bei Kreditauskunfteien durchgeführt und Inkassodaten im gesetzlich zulässigen Umfang an diese weitergegeben. Zum Zweck der Entscheidung über die Begründung, Durchführung oder Beendigung des Vertragsverhältnisses erheben und verwenden wir auch Wahrscheinlichkeitswerte, in deren Berechnung unter anderem Anschriftendaten einfließen.
- (2) Angaben zu Telefon- und Telefaxanschlussnummer, E-Mail-Adresse und Bankverbindung des Kunden werden bei uns nur zu den in Absatz 1, Satz 1 genannten Zwecken gespeichert und verwendet.

Bingen am Rhein, 09/2023

general terms and conditions of business

§1 scope of application and protective clause

- (1) The following General Terms and Conditions apply to all contracts for the supply of goods and the provision of performances by us and to all related legal relationships.
- (2) Other, contrary or supplementary general terms and conditions will not become part of the contract even if we are aware of them.
- (3) The following General Terms and Conditions will apply to business entities and will also apply to future contracts.

§2 quotes and performances, non-binding nature of information

- (1) Publications concerning goods and performances that we have released do not constitute binding proposals.
- (2) An order placed by a customer constitutes a binding proposal to which this customer will be bound for a period of two weeks. We will be entitled to accept this proposal by sending a confirmation of order but also by delivering the ordered goods or providing the ordered performance.
- (3) All information provided about colours, dimensions and technical parameters will not be binding in the event of any doubt. The content of design drawings, illustrations and data sheets will in the event of any doubt not constitute any contractually agreed composition. In the event of our proposal containing a list of specific performances, our obligation to perform will in the event of any doubt be limited to the performances that have been listed.
- (4) All prices stated will in the event of any doubt be stated in Euros and without value added tax. In the event of any doubt, the price lists and hourly rates valid at the time the contract is concluded will apply. Travelling to and from site will be charged separately.
- (5) We reserve all rights in all drawings, plans and pricing documents that have been drawn up for the customer. These must be treated as confidential and may not be forwarded to third parties, made public or published without our consent. In the event that we prepare drawings and plans that relate to an order that the customer has not yet placed, the customer will only be provided with the drawings and plans that we have prepared for further use when the customer pays a fee of 5% of the gross total of the proposal.

§3 non-binding nature of time limits and deadlines, partial deliveries

- (1) The time limits and dates we specify for deliveries and performances will in the event of doubt be non-binding and subject to change without notice.
- (2) We will be entitled to make partial deliveries and performances.

§4 collaborative actions by the customer

- (1) The customer will be obliged to ensure that the specifications provided for our work and the content of the customer's order do not breach legal standards or official regulations, particularly those set out by building law, or violate the private rights of third parties and to ensure that the official permits and third-party consents are available before our work is carried out.
- (2) The customer will be obliged to provide unhindered access to the construction site during the period of execution. Customers must provide the electricity and water required for construction as well as opportunities for the proper disposal of waste and waste water at their own cost.
- (3) To the extent required for the provision of our performances, customers will be obliged to put plans and documents, particularly those pertaining the situation at site and in the building, at our disposal and provide the information, particularly about the conditions of the floors and the location of lines and connections, required to this end.
- (4) Customers will at our request be obliged to provide instructions for the execution of performances within a reasonable time limit should the information they have provided be incomplete or incorrect and we have advised them of our corresponding concerns.
- (5) If customers culpably breach their obligations set out in Paragraphs 1 to 4 or if their performances are delayed, they will be required to compensate us for any losses incurred, including the expenditure for required temporary storage and for labour costs for our employees. Should customers culpably not fulfil their obligations even after a reasonable time limit has been set or after we have issued a warning, we will be entitled to terminate the contract without notice. The statutory provisions regarding delays in acceptance and liability for damages will remain unaffected.

§5 collateral

- (1) All supplied goods and materials will remain our property until they have been paid for in full. Without our prior consent, customers will be prohibited from mixing, combining or processing items that are our property with other items and are prohibited from disposing of such items in any legal way.

We already undertake to grant this consent should customers provide suitable collateral to the equivalent of the price charged for the respective items.

- (2) If we carry out work on a movable item provided by customers, a right of lien will be established for this item to secure our claim for remuneration for work carried out on this item.

§6 terms of payment, offsetting, assignment

- (1) The granting of periods allowed for payment, discounts and cash discounts requires express written agreement.
- (2) It will be possible to offset claims against our claims only if these claims are undisputed or they have been established in a legally effective manner. Customers may only exercise their right of retention if and to the extent that their counterclaim is based on the same contractual relationship.
- (3) Customers may transfer or pledge their rights and claims arising out of the contractual relationship to third parties – also by way of security – only with our written consent.

§7 transfer of risk on sale

In the event of the sale of goods to customers who are not consumers, the risk of accidental loss and accidental deterioration of the goods will pass to the customer with the handover of the goods, with the handover to the transporting person in the event of dispatch, on receipt by the customer of the notification of delivery readiness in the event of deliveries on call. Transporting persons will also be our own staff tasked with dispatch and transport.

§8 limitation of warranty and liability

- (1) We provide no guarantees and do not warrant any special properties. In the event of any doubt, we reject any obligation to meet claims for financial subsidies from private or public funds, the granting of feed-in tariffs by utility companies in regard to systems, facilities or devices we have set up, modified, repaired or maintained or to achieve certain specific limits.
- (2) The rights from the warranty for defects will otherwise be determined by the statutory provisions. Customers which are businesses must furthermore observe the statutory inspection and complaint obligations.

§9 applicable law and jurisdiction clause

- (1) The law of the Federal Republic of Germany with the exception of the laws governing the international sale of goods will apply to all legal relationships between the parties as defined in § 1 Section 1.
- (2) For customers which are businesses, legal entities under public law or public fund assets, the ordinary first-instance courts responsible for 55411 Bingen will be agreed as the locally responsible courts for disputes arising out of the legal relationships between the parties as defined in § 1 Section 1. Clause 1 further applies to all other customers that, without being consumers domiciled in the European Union, do not have a general place of jurisdiction in the Federal Republic of Germany, move their domicile, seat or habitual residence out of the Federal Republic of Germany after the contract was concluded or whose domicile, seat or habitual residence is not known at the time action is commenced.

§10 data protection notice

- (1) We will electronically store and process the customer's name, company name, legal form, address and the names of its representatives for the purposes of fulfilling contractual and legal obligations and for exercising contractual rights and enforcing contractual claims. Where customers for whom we perform in advance are concerned, we will already make creditworthiness inquiries at credit bureaus and forward collection data to these to the extent permitted by the law when contract negotiations commence and during the further execution of the contract. We will also collate and use probability values the calculation of which uses address information and other details to reach decisions regarding the justification, execution or termination of the contractual relationship.
- (2) We will only store and use information regarding the customers' telephone and telefax connection numbers, email addresses and banking details for the purposes defined in Section 1 Clause 1.

The English translation is only provided as a courtesy and for the customer's information. The German version of these terms applies exclusively.

Bestellinformationen

delivery information

Lieferzeit

Regellieferzeit ist 2 Wochen nach Auftragsbestätigung, sofern alle benötigten Materialien auf Lager vorhanden sind. Bitte beachten Sie Angaben hierzu auf Ihrer Auftragsbestätigung.

Erforderliche Angaben auf Ihrer Bestellung

- Produktname
- vollständige Artikelnummer (inklusive den zu ergänzenden Angaben z. B. Lichtfarbe, Cover- oder Linsentyp usw.)
- gewünschte Lieferzeit
- Besteller, Rechnungsadresse und Lieferadresse

Bestelladresse

FLASHAAR® LEDLight GmbH & Co. KG
Gaustraße 13–15
55411 Bingen am Rhein
Deutschland

FON +49 6721 9195-0
FAX +49 6721 9195-91
bestellung@ledlight.flashaar.com
www.flashaar.de

Versandkosten

Wir berechnen Ihnen ausschließlich die tatsächlich anfallenden Versandkosten. Je nach Auftragswert und Quantität fallen zusätzliche Verpackungskosten an.

Ausgabe

Ausgabe V6 – 2023/09
Druckfehler, Irrtum und technische Änderungen sind vorbehalten.

delivery time

Delivery time is normally 2 week after order confirmation, so far all necessary materials are in stock available. Please see details on this point on your order confirmation.

information required on your order

- product name
- complete item number (including specification codes e.g. light colour, cover or lens type etc.)
- required delivery period
- customer, billing address and delivery address

ordering address

FLASHAAR® LEDLight GmbH & Co. KG
Gaustraße 13–15
55411 Bingen am Rhein
Germany

FON +49 6721 9195-0
FAX +49 6721 9195-91
order@ledlight.flashaar.com
www.flashaar.de

indicative value of shipping costs

Please note, we charge you only the actual delivery costs. Additional handling charges may be apply depending on order value and quantity.

edition

edition V6 – 2023/09
Technical changes, errors and printing mistakes are reserved.





Sprechen Sie mit uns über Ihr Projekt Let's talk about your project

Langjährige Geschäftsbeziehungen mit Kunden und Zulieferern sind ein Erfolg unserer Arbeit. Persönlicher Kontakt, schnelle Reaktion auf alle Anfragen und enge Zusammenarbeit sind gelebte Werte bei FLASHAAR®. Sprechen Sie mit unserem Vertriebsteam über Ihr Projekt.

Long-term business relationships with customers and suppliers represent one aspect of the success of our work. Personal contact, rapid response to all inquiries and close cooperation are the values that are lived at FLASHAAR®. Our sales team is looking forward to talking to you about your project.

Ausgabe 2023_v06 (gültig ab 09/2023)
Edition 2023_v06 (valid from 09/2023)



FLASHAAR LEDLight GmbH & Co. KG

Gaustraße 13-15 | D-55411 Bingen am Rhein | Germany
FON: +49 6721 9195-0 | FAX: +49 6721 9195-91 | info@ledlight.flashaar.com | www.flashaar.de

© Forum Schwanthalerhöhe, München / Ole Heinrich Corporate Photography

